

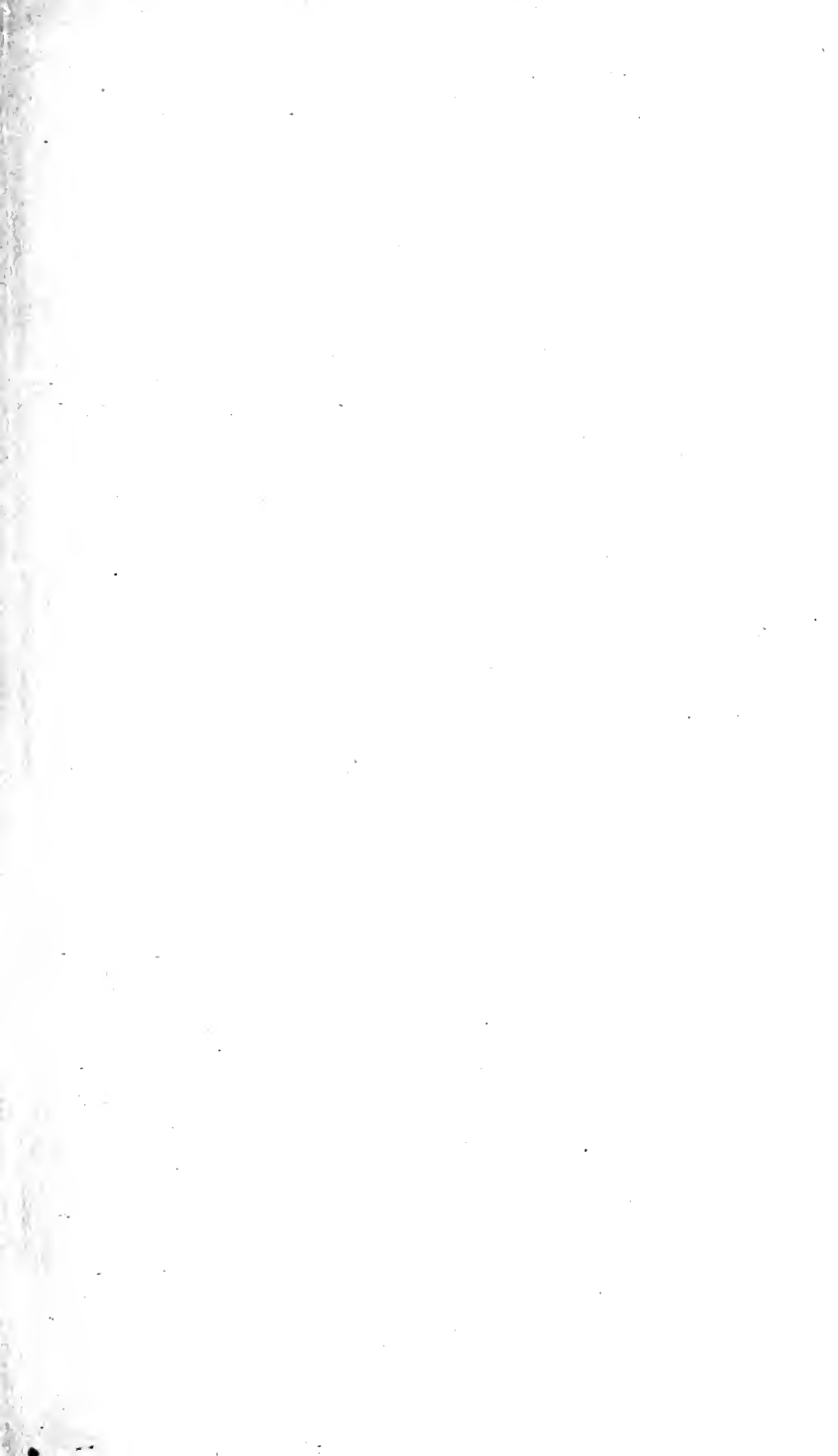

3 1761 06704283 8





Digitized by the Internet Archive
in 2007 with funding from
Microsoft Corporation



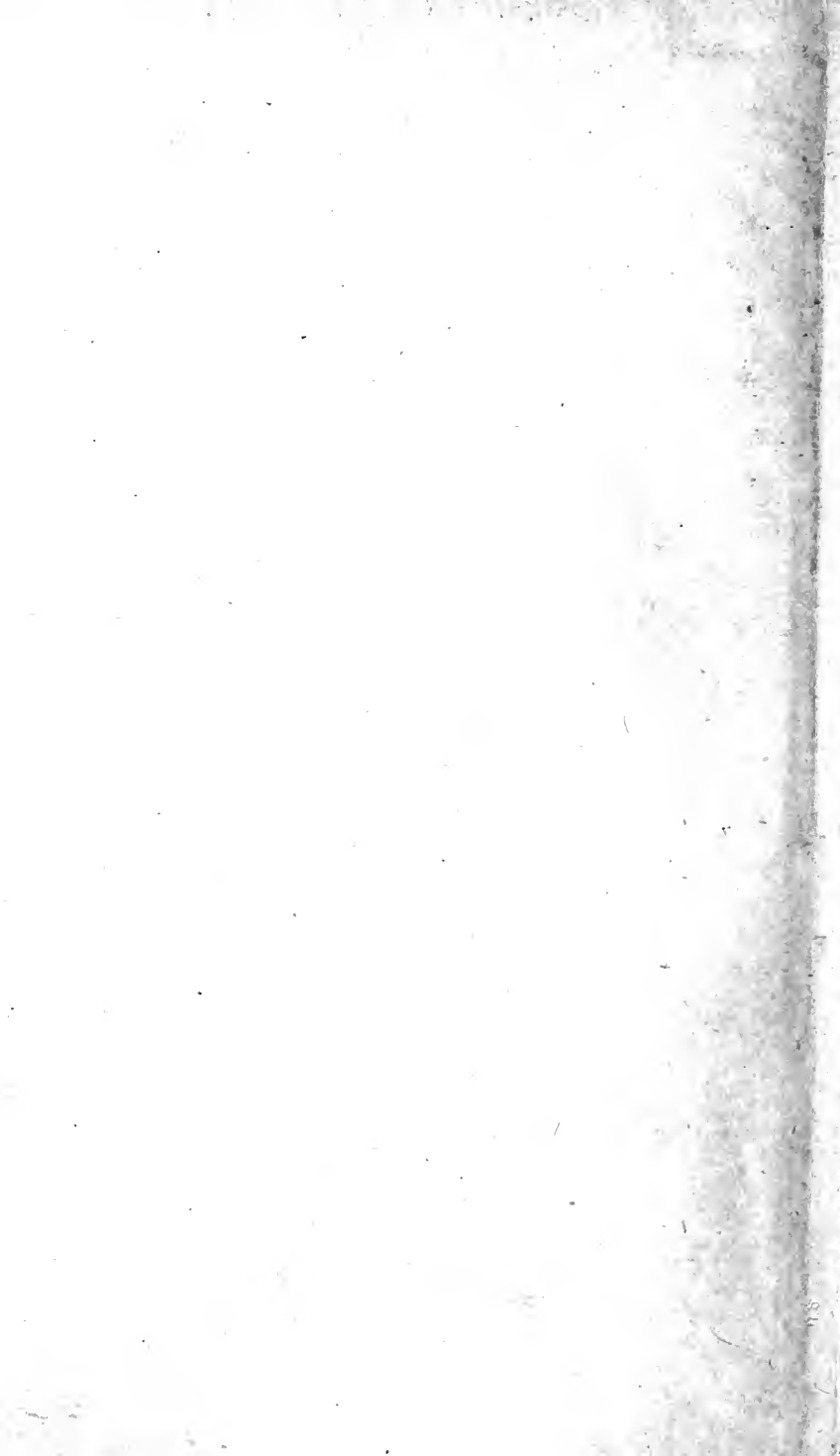

FUNCTIONS OF A COMPLEX VARIABLE



MACMILLAN AND CO., LIMITED
LONDON · BOMBAY · CALCUTTA · MADRAS
MELBOURNE

THE MACMILLAN COMPANY
NEW YORK · BOSTON · CHICAGO
DALLAS · SAN FRANCISCO

THE MACMILLAN CO. OF CANADA, LTD.
TORONTO

47

FUNCTIONS

OF A

COMPLEX VARIABLE

BY

THOMAS M. MACROBERT

M.A., B.Sc.

LECTURER IN MATHEMATICS IN THE UNIVERSITY OF GLASGOW
FORMERLY SCHOLAR OF TRINITY COLLEGE, CAMBRIDGE

147270
8 | 10 | 18

MACMILLAN AND CO., LIMITED
ST. MARTIN'S STREET, LONDON

1917

COPYRIGHT

GLASGOW ; PRINTED AT THE UNIVERSITY PRESS
BY ROBERT MACLEHOSE AND CO. LTD.

PREFACE

THIS book is designed for students who, having acquired a good working knowledge of the calculus, desire to become acquainted with the theory of functions of a complex variable, and with the principal applications of that theory. In order to avoid making the subject too difficult for beginners, I have abstained from the use of strictly arithmetical methods, and have, while endeavouring to make the proofs sufficiently rigorous, based them mainly on geometrical conceptions.

The first two chapters are intended to familiarise the student with the geometrical representation of complex numbers and of the simpler rational and irrational functions of a complex variable.

In Chapter III. the properties of holomorphic functions are established; these properties are then used to define the Exponential, Circular, Logarithmic, and other transcendental functions for the domain of the complex variable, their properties as functions of a real variable being assumed to be known. It is thus possible in Chapter IV. to make use of these functions in examples on integration; such examples are both interesting and important, and it seems desirable to introduce them to the student in a manner that does not involve the difficulties of complex series. As a preliminary to Green's Theorem I have given a short account of curvilinear integrals. Two proofs of Cauchy's Theorem are given, only the first of which depends on Green's Theorem. A large number of examples on contour integration are worked out, and here, as throughout the book, the text is plentifully illustrated by diagrams.

In view of the very full exposition of the subject given by Dr. Bromwich, it has been thought unnecessary to give a detailed account of infinite series. A summary of those theorems which are used in the book will be found at the beginning of Chapter V.; the theory of uniform convergence is dealt with in Chapter VI.

The remaining chapters are devoted to the applications of the subject. Chapter VII. includes, among other matters, the theory of Analytical Continuation; various examples of the applications of that theory are given there and in Chapters VIII. and XV. The asymptotic expansions of the Gamma Function in Chapter VIII. and of the Bessel Functions in Chapter XV. are worked out for complex values of the variable.

Chapters IX. to XI. deal with Elliptic Integrals and Functions. In Chapter IX. the student is shown how to reduce and evaluate elliptic integrals. In Chapter XI. I have established the existence of the Jacobian Functions by considering the values of the Weierstrassian Function when one period is real and the other is purely imaginary.

The last four chapters of the book contain a discussion of the theory of linear differential equations. As the most important of these equations are of the second order, it has been thought unnecessary to consider equations of higher order than the second. The Hypergeometric Function and Spherical and Cylindrical Harmonics are discussed as they arise through the solution of their differential equations; other properties of these functions are given in examples, with, in most cases, hints as to the methods of solution. No attempt has been made to deal with the applications of these functions to physics, but it is hoped that the applied mathematician will find in these pages ready access to the instruments which he requires.

Numerous examples have been given throughout the book, and there is also a set of Miscellaneous Examples, arranged to correspond with the order of the text.

The writing of the book was undertaken at the suggestion of Professor George A. Gibson, LL.D., to whom I have been

indebted for important criticisms at all stages of the work. I have also to thank my colleagues, Mr. Robert J. T. Bell, D.Sc., and Mr. Arthur S. Morrison, M.A., B.Sc., for their assistance in correcting the proofs.

Acknowledgment has been made, in foot-notes to the text, of various sources from which I have derived assistance. Of the books which I have found helpful I would particularly name Lindelöf's *Calcul des Résidus*, Cauchy's *Mémoire sur les intégrales définies*, Jordan's *Cours d'Analyse*, and Forsyth's *Theory of Differential Equations*. I have also made use of lectures by Mr. R. A. Herman, M.A., and Professor E. W. Hobson, Sc.D.

In conclusion, I would express my thanks to Messrs. MacLehose for the excellence of their printing work.

THOMAS M. MACROBERT.

GLASGOW, *September* 1916.



CONTENTS

CHAPTER I.

COMPLEX NUMBERS.

SECT.		PAGE
1.	Definition of Complex Numbers - - - - -	1
2.	Geometrical Representation of Complex Numbers - - -	1
3.	Modulus and Amplitude. Vectors - - - - -	2
4.	Geometrical Representation of Addition. Subtraction - -	3
5.	Multiplication and Division - - - - -	4
6.	Root Extraction - - - - -	5
	<i>Examples I.</i> - - - - -	6

CHAPTER II.

FUNCTIONS OF A COMPLEX VARIABLE.

7.	Uniform and Multiple-valued Functions. Path of Variation -	7
8.	Transformations. Point at Infinity - - - - -	7
9.	Geometrical Representation of Functions. Branch Points -	10
10.	Roots of Equations - - - - -	16
	<i>Examples II.</i> - - - - -	19

CHAPTER III.

HOLOMORPHIC FUNCTIONS.

11.	Limits - - - - -	22
12.	Continuity - - - - -	23
13.	Uniform Continuity. Functions of Two Real Variables - -	24
14.	Differentiation - - - - -	26
15.	Definition of Holomorphic Functions. Simply-connected Regions. Inverse Functions. Harmonic Functions - -	27

SECT.	PAGE
16. The Exponential Function - - - - -	32
17. Circular Functions. Hyperbolic Functions - - - - -	33
18. The Logarithmic Function. The Inverse Tangent Function -	34
19. The Transformation $w = \text{Log } z$ - - - - -	35
20. The Generalised Power - - - - -	36
21. Conformal Representation - - - - -	37
22. Singular Points. Poles. Meromorphic Functions. Essential Singularities. Branch Points. Zeros. Theorems - -	38
<i>Examples III.</i> - - - - -	40

CHAPTER IV.

INTEGRATION.

23. Convergence and Uniform Convergence of Sequences - - -	42
24. Curvilinear Integrals. Differentiation under the Integral Sign -	42
25. Green's Theorem - - - - -	45
26. Definite Integrals - - - - -	48
27. Cauchy's Integral Theorem. Theorems on Integration - -	51
28. Cauchy's Theorem: Alternative Proof - - - - -	54
29. Cauchy's Residue Theorem. Residue at Infinity - - -	57
30. Evaluation of Definite Integrals. Theorems on Limiting Values of Integrals. Principal Value of an Integral - - -	59
31. Cauchy's Integral - - - - -	67
32. Liouville's Theorem - - - - -	68
33. The Fundamental Theorem of Algebra - - - - -	69
34. Differentiation and Integration under the Integral Sign - -	69
35. Derivatives of a Holomorphic Function - - - - -	70
<i>Examples IV.</i> - - - - -	71

CHAPTER V.

CONVERGENCE OF SERIES: TAYLOR'S AND LAURENT'S
SERIES.

36. Convergence of Series. Absolute Convergence. Multiplication of Series. Ratio Tests. The Hypergeometric Series - -	76
37. Convergence of a Double Series - - - - -	78
38. Power Series. Circle of Convergence. Abel's Test. Multipli- cation of Power Series - - - - -	80

CONTENTS

xi

SECT.	PAGE
39. Taylor's Series - - - - -	82
40. Laurent's Series. Principal Part at a Pole - - - - -	84
41. Fourier Series. Periodic Functions - - - - -	86
42. Classification of Uniform Functions. Integral, Rational Integral, and Transcendental Integral Functions. Theorems - - -	88
<i>Examples V.</i> - - - - -	89

CHAPTER VI.

UNIFORMLY CONVERGENT SERIES: INFINITE PRODUCTS.

43. Uniformly Convergent Series. Continuity. Integration. Dif- ferentiation. Weierstrass's M Test - - - - -	92
44. Uniform Convergence of Power Series. Undetermined Co- efficients - - - - -	95
45. Additional Contour Integrals - - - - -	97
46. Legendre Polynomials. Expression in Definite Integral Forms. Recurrence Formula - - - - -	99
47. Expansion of $\cot z$ in a Series of Fractions - - - - -	103
48. Mittag-Leffler's Theorem. Weierstrass's Zeta Function. Weier- strass's Elliptic Function - - - - -	105
49. Infinite Products. Unconditional Convergence - - - - -	107
50. Weierstrass's Theorem. The Gamma Function. Weierstrass's Sigma Function - - - - -	108
<i>Examples VI.</i> - - - - -	109

CHAPTER VII.

VARIOUS SUMMATIONS AND EXPANSIONS.

51. Expansions in Series by means of Residues. Theorems on Limiting Values of Integrals - - - - -	113
52. Summation of Series by means of Residues. Gauss's Sum - - -	116
53. Theorems on Roots of Equations - - - - -	118
54. Lagrange's Expansion. Rodrigues' Formula. Integrals involv- ing Legendre Coefficients - - - - -	119
55. Analytical Continuation. Theorems. Recurrence Formula for Legendre Coefficients - - - - -	122
56. Abel's Theorem - - - - -	125
<i>Examples VII.</i> - - - - -	128

CHAPTER VIII.

GAMMA FUNCTIONS.

SECT.		PAGE
57.	The Bernoulli Numbers. Expression as Definite Integrals - -	132
58.	Asymptotic Expansion of Euler's Constant - - - -	134
59.	Convergent Integrals - - - - -	136
60.	Uniformly Convergent Integrals. Differentiation and Integration under the Integral Sign - - - - -	137
61.	The Gamma Function. Gauss's Definition. Formulae. The Function $\psi(z)$. Gauss's Function $\Pi(z)$. Euler's Definition. Expression as a Contour Integral. Gauss's Theorem - -	141
62.	The Beta Function. Duplication Formula for the Gamma Function - - - - -	144
63.	Asymptotic Expansion of the Gamma Function. Analytical Continuation of the Hypergeometric Function - - -	146
	<i>Examples VIII.</i> - - - - -	154

CHAPTER IX.

INTEGRALS OF MEROMORPHIC AND MULTIFORM FUNCTIONS:
ELLIPTIC INTEGRALS.

64.	Integrals of Meromorphic Functions. The Logarithmic Function	160
65.	Integrals of Multiform Functions. The Inverse Sine Function -	161
66.	Legendre's First Normal Elliptic Integral. Inversion of the Integral - - - - -	163
67.	The Weierstrassian Elliptic Integral. Inversion of the Integral	167
68.	Elliptic Integrals in General. Legendre's Normal Integrals -	169
69.	Complete Elliptic Integrals. Landen's Transformation - -	173
70.	Legendre's Relation - - - - -	175
	<i>Examples IX.</i> - - - - -	176

CHAPTER X.

WEIERSTRASSIAN ELLIPTIC FUNCTIONS.

71.	Doubly-Periodic Functions. Theorem on Primitive Periods. Congruent Points. Period-Parallelograms - - - -	179
72.	Elliptic Functions. Weierstrass's Elliptic Function. Theorems on Poles and Zeros of Elliptic Functions - - - -	180

CONTENTS

xiii

SECT.	PAGE
73. Relation between $\wp(z)$ and $\wp'(z)$. The Weierstrassian Elliptic Integral - - - - -	183
74. The Addition Theorem for $\wp(z)$ - - - - -	185
75. Properties of Weierstrass's Zeta Function. Legendre's Relation. Expression of Elliptic Functions in Terms of Zeta Functions -	187
76. Properties of the Sigma Function. Expression of Elliptic Functions in Terms of Sigma Functions - - - - -	189
<i>Examples X.</i> - - - - -	191

CHAPTER XI.

JACOBIAN ELLIPTIC FUNCTIONS.

77. The Values of $\wp(w; \omega_1, \omega_2)$ when ω_1 is Real and ω_2 is Purely Imaginary - - - - -	194
78. Geometric Application - - - - -	196
79. The Jacobian Elliptic Functions $\operatorname{sn} u, \operatorname{cn} u, \operatorname{dn} u$. Periods. Poles	198
80. The Addition Theorems for $\operatorname{sn} u, \operatorname{cn} u, \operatorname{dn} u$ - - - - -	202
81. Jacobi's Imaginary Transformation - - - - -	205
<i>Examples XI.</i> - - - - -	206

CHAPTER XII.

LINEAR DIFFERENTIAL EQUATIONS.

82. Continuation of a Function by Successive Elements - - -	208
83. Homogeneous Linear Differential Equations of the Second Order. Existence of an Integral in the Domain of an Ordinary Point. Integrals at Infinity. Analytical Continuation of the Integral	209
84. Solution by Infinite Series. Legendre's Equation. Legendre's Function of the First Kind - - - - -	213
85. Theorems on Fundamental Systems of Integrals - - - - -	215
<i>Examples XII.</i> - - - - -	217

CHAPTER XIII.

REGULAR INTEGRALS OF LINEAR DIFFERENTIAL EQUATIONS.

86. Integrals in the Neighbourhood of a Singularity. The Fundamental Equation. The Associated Fundamental System -	219
87. Regular Integrals. Conditions for Regular Integrals - - -	222
88. The Method of Frobenius. The Indicial Equation. Solutions Free from Logarithms - - - - -	225

SECT.	PAGE
89. The Gaussian Differential Equation. The Differential Equation of the Quarter Periods of the Jacobian Elliptic Functions -	228
<i>Examples XIII.</i> - - - - -	232

CHAPTER XIV.

LEGENDRE'S AND BESSEL'S EQUATIONS: EQUATIONS OF FUCHSIAN TYPE.

90. Legendre Functions of the First and Second Kinds. Recurrence Formulae - - - - -	234
91. Bessel Functions of the First and Second Kinds. Recurrence Formulae. The Function $G_n(z)$. Relations between the Bessel Functions. The Zeros of $J_n(z)$ - - - - -	236
92. Equations of Fuchsian Type - - - - -	243
93. Riemann's P-function. The Twenty-four Integrals of the Hypergeometric Equation. Analytical Continuation of the Hypergeometric Function - - - - -	244
94. Spherical Harmonics. Legendre's Associated Functions of the First and Second Kinds - - - - -	249
<i>Examples XIV.</i> - - - - -	252

CHAPTER XV.

SOLUTION OF DIFFERENTIAL EQUATIONS BY DEFINITE INTEGRALS.

95. First Method of Solution. The Branch Points of the Integral -	255
96. Gauss's Equation. Definite Integral Form of the Hypergeometric Function - - - - -	258
97. Legendre's Associated Equation. Expressions for $P_n^m(z)$ and $Q_n^m(z)$ - - - - -	259
98. Second Method of Solution - - - - -	266
99. Bessel's Equation. Definite Integral Expressions for $J_n(z)$ and $G_n(z)$ - - - - -	266
100. Asymptotic Expansions of $G_n(z)$ and $J_n(z)$ - - - - -	271
<i>Examples XV.</i> - - - - -	275
MISCELLANEOUS EXAMPLES - - - - -	277
INDEX - - - - -	294

CHAPTER I.

COMPLEX NUMBERS.

† 1. **Definition of Complex Numbers.** A number of the form $p+iq$, where p and q are real and i is a root of the equation $i^2+1=0$, is called a *Complex Number*. If $q=0$ the number is said to be purely real, and if $p=0$ it is said to be purely imaginary. The complex numbers $p+iq$ and $p-iq$ are called *Conjugate Numbers*. The number $p+iq$ is zero if and only if $p=0$ and $q=0$.

If $\rho=p+iq$, it is frequently found convenient to write $R(\rho)$ for p and $I(\rho)$ for q , where $R(\rho)$ stands for *the real part of ρ* and $I(\rho)$ for *the imaginary part of ρ* .

Complex Numbers are subject to the same algebraical laws of addition, subtraction, multiplication, and division, as real numbers. These operations, when applied to real and complex numbers, produce real and complex numbers only; and it will be shewn (§§ 6, 20) that this is also true of the remaining algebraical operation of root extraction.

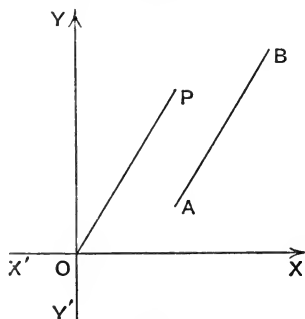

FIG. 1.

2. **Geometrical Representation of Complex Numbers.** The Complex Number $z=x+iy$ can be represented geometrically by

means of a Rectangular Coordinate System $X'OX, Y'OY$ (Fig. 1). The point $P(x, y)$ corresponds uniquely to the number z , and is called the point z . In particular, points on the x -axis correspond to purely real numbers, and points on the y -axis to purely imaginary numbers. The figure is called the *Argand Diagram*, and the coordinate plane is spoken of as the z -plane.

✓ *Example.* If z_1 and z_2 are conjugate numbers, shew that the straight line joining the points z_1 and z_2 is bisected at right angles by the x -axis.

3. Modulus and Amplitude. In polar coordinates P is the point (r, θ) , where r denotes the *positive* value of OP , and θ the angle XOP . The angle XOP is defined as the angle traced out by a radius-vector which revolves either positively or negatively from its initial position along OX till it coincides with OP . OP or r is called the *Modulus* of z , and is written $\text{mod } z$ or $|z|$; θ is called the *Amplitude** of z , and is written $\text{amp } z$. The amplitude can evidently have an infinite number of values differing from each other by multiples of 2π : that value which satisfies the inequalities

$$-\pi < \theta \leq \pi$$

is called the *Principal Value* of $\text{amp } z$.

The rectangular and polar coordinates are connected by the relations

$$\begin{aligned} x &= r \cos \theta, & y &= r \sin \theta, \\ r &= \sqrt{x^2 + y^2}, & \tan \theta &= y/x. \end{aligned}$$

From these it follows that

$$z = x + iy = r(\cos \theta + i \sin \theta),$$

an equation which expresses z in terms of its modulus and amplitude.

✓ *Example 1.* Prove $|\cos \theta + i \sin \theta| = 1$.

✓ *Example 2.* If $z = x + iy$, shew that $|x| \leq |z|$, $|y| \leq |z|$.

Vectors. A line \overline{AB} (Fig. 1), equal to, parallel to, and in the same direction as OP , may also be used to represent the number z ; $\text{mod } (\overline{AB})$ and $\text{amp } (\overline{AB})$ are then identical with $|z|$ and $\text{amp } z$. \overline{AB} is called a *Vector*. It follows that

$$\overline{BA} = -\overline{AB}.$$

* The word *Argument* is used by some writers in place of Amplitude.

4. Geometrical Representation of Addition. Let P_1 and P_2 (Fig. 2) be the points $z_1 = x_1 + iy_1$ and $z_2 = x_2 + iy_2$. Then

$$z_1 + z_2 = (x_1 + x_2) + i(y_1 + y_2).$$

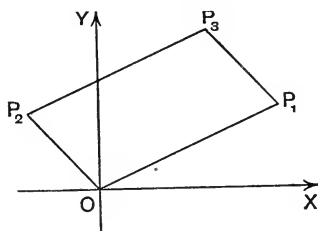

FIG. 2.

Through P_1 draw P_1P_3 equal to, parallel to, and in the same direction as OP_2 . P_3 has coordinates $(x_1 + x_2, y_1 + y_2)$, and is therefore the point $z_1 + z_2$. In vectorial notation

$$\overline{OP_3} = \overline{OP_1} + \overline{P_1P_3} = \overline{OP_1} + \overline{OP_2} = \overline{OP_2} + \overline{P_2P_3}.$$

Subtraction. Since $z_1 - z_2 = z_1 + (-z_2)$, a subtraction can always be treated as an addition. Thus, if P_3 (Fig. 2) is the point z_3 ,

$$z_3 - z_2 = \overline{OP_3} - \overline{OP_2} = \overline{OP_3} + \overline{P_3P_1} = \overline{OP_1} = z_1.$$

THEOREM I. The modulus of the sum of any number of complex quantities is less than or equal to the sum of their moduli: that is, if n is any positive integer,

$$|z_1 + z_2 + \dots + z_n| \leq |z_1| + |z_2| + \dots + |z_n|.$$

This follows from the geometrical theorem that a side of a triangle is less than or equal to the sum of the other two sides: thus (Fig. 2)

$$\text{mod}(\overline{OP_3}) \leq \text{mod}(\overline{OP_1}) + \text{mod}(\overline{P_1P_3}).$$

Therefore $|z_1 + z_2| \leq |z_1| + |z_2|.$

Hence $|z_1 + z_2 + z_3| \leq |z_1 + z_2| + |z_3|$
 $\leq |z_1| + |z_2| + |z_3|;$

and so on.

THEOREM II. The modulus of the difference of two complex quantities is greater than or equal to the difference of their moduli.

The verification of this theorem is left as an exercise to the reader.

5. Multiplication and Division. Let $z_1 = r_1(\cos \theta_1 + i \sin \theta_1)$,
 $z_2 = r_2(\cos \theta_2 + i \sin \theta_2)$, ..., $z_n = r_n(\cos \theta_n + i \sin \theta_n)$.

Then, by De Moivre's theorem,

$$z_1 z_2 \dots z_n = r_1 r_2 \dots r_n \{ \cos(\theta_1 + \theta_2 + \dots + \theta_n) \\ + i \sin(\theta_1 + \theta_2 + \dots + \theta_n) \}.$$

Hence, the modulus and amplitude of a product are equal respectively to the product of the moduli and the sum of the amplitudes of the factors.

In particular, if n is a positive integer, and if $z = r(\cos \theta + i \sin \theta)$, then

$$z^n = r^n(\cos n\theta + i \sin n\theta).$$

Example. If $p + iq$ is a root of the equation

$$a_0 z^n + a_1 z^{n-1} + \dots + a_n = 0,$$

where the coefficients a_0, a_1, \dots, a_n are real, prove that $p - iq$ is also a root.

Again, $\frac{z_1}{z_2} = \frac{r_1}{r_2} \{ \cos(\theta_1 - \theta_2) + i \sin(\theta_1 - \theta_2) \}$;

so that the modulus and amplitude of a quotient are respectively the quotient of the moduli and the difference of the amplitudes of the numerator and denominator.

It follows that the equation

$$z^n = r^n(\cos n\theta + i \sin n\theta)$$

holds when n is a negative integer. In particular,

$$\text{mod}(1/z) = 1/|z| \quad \text{and} \quad \text{amp}(1/z) = -\text{amp } z.$$

✓ *Example 1.* Give a geometrical construction for $1/z$.

✓ *Example 2.* Shew that $\text{amp}\left(\frac{\overline{AC}}{\overline{AB}}\right) = \widehat{BAC}$.

Let OP and OQ be parallel to and in the same direction as AB and AC.

$$\begin{aligned} \text{Then} \quad \text{amp}\left(\frac{\overline{AC}}{\overline{AB}}\right) &= \text{amp } \overline{AC} - \text{amp } \overline{AB} \\ &= \text{amp } \overline{OQ} - \text{amp } \overline{OP} \\ &= \widehat{POQ} = \widehat{BAC}. \end{aligned}$$

If the angle so obtained is a positive {Fig. 3(a)} or a negative {Fig. 3(b)} reflex angle, the principal value of the amplitude of the quotient is obtained in the first case by subtracting and in the second case by adding 2π ; the resulting amplitude is in the first case negative and in the second case positive. As a rule, when the amplitude is mentioned, it is to be understood that the principal value is referred to.

✓ *Example 3.* Shew that, if $\text{amp} \left(\frac{z_2 - z_3}{z_1 - z_3} \right) = \text{amp} \left(\frac{z_2 - z_4}{z_1 - z_4} \right)$, the points z_3 and z_4 are on the same side of the line joining z_1 and z_2 , and z_1, z_2, z_3, z_4 , are concyclic.

Let P_1, P_2, P_3 , and P_4 be the points z_1, z_2, z_3 , and z_4 respectively. Then

$$\text{amp} \left(\frac{z_2 - z_3}{z_1 - z_3} \right) = P_1 \hat{P}_3 P_2; \quad \text{amp} \left(\frac{z_2 - z_4}{z_1 - z_4} \right) = P_1 \hat{P}_4 P_2.$$

Therefore $P_1 \hat{P}_3 P_2 = P_1 \hat{P}_4 P_2$.

Moreover, the points P_3 and P_4 must be on the same side of the line $P_1 P_2$; for if not, the angles $P_1 P_3 P_2$ and $P_1 P_4 P_2$ would have opposite signs.

Hence the points P_1, P_2, P_3 , and P_4 are concyclic.

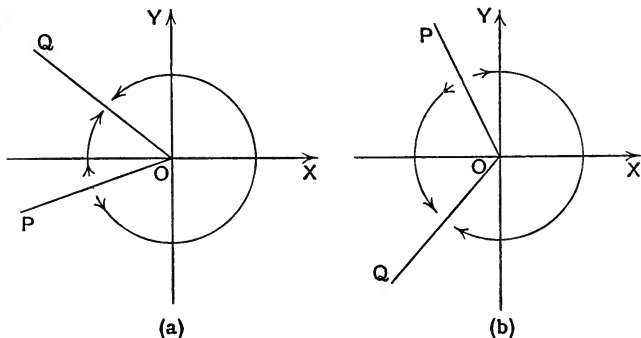

FIG. 3.

6. Root Extraction. If n is a positive integer there are n distinct values of $z^{\frac{1}{n}}$.

For, since, if κ is any integer,

$$\left(\cos \frac{\theta + 2\kappa\pi}{n} + i \sin \frac{\theta + 2\kappa\pi}{n} \right)^n = \cos \theta + i \sin \theta,$$

it follows that $r^{\frac{1}{n}} \left(\cos \frac{\theta + 2\kappa\pi}{n} + i \sin \frac{\theta + 2\kappa\pi}{n} \right)$ is an n^{th} root of $z = r(\cos \theta + i \sin \theta)$. Now, if for κ the numbers $0, 1, 2, 3, \dots, n-1$, are substituted in succession, n distinct values of $z^{\frac{1}{n}}$ are obtained. The substitution of other integers for κ merely gives rise to repetitions of these values; and there can be no other values, since $z^{\frac{1}{n}}$ is a root of the equation $x^n = z$, which has not more than n roots.

Similarly, if p and q are integers, and q is positive,

$$z^{\frac{p}{q}} = r^{\frac{p}{q}} \left(\cos \frac{p\theta + 2\kappa\pi}{q} + i \sin \frac{p\theta + 2\kappa\pi}{q} \right),$$

where $\kappa = 0, 1, 2, \dots, q-1$.

✓ *Example.* Shew that the n^{th} roots of any number can be represented by n equidistant points on a circle with centre at the origin.

EXAMPLES I.

1. Shew that the straight line joining the points z_1 and z_2 is divided in the ratio $m : n$ at the point $(mz_2 + nz_1)/(m + n)$.

2. Prove that the centroid of the triangle whose vertices are z_1, z_2 , and z_3 is $(z_1 + z_2 + z_3)/3$.

✓ 3. Prove that the modulus of the quotient of two conjugate numbers is unity.

4. Prove that $\text{amp } z - \text{amp } (-z) = \pm \pi$ according as $\text{amp } z$ is positive or negative.

✓ 5. If $|z_1| = |z_2|$, and $\text{amp } z_1 + \text{amp } z_2 = 0$, shew that z_1 and z_2 are conjugate numbers.

✧ 6. If $2 \cos \theta = a + 1/a$, shew that $2 \cos n\theta = a^n + 1/a^n$. *induction*

7. Prove algebraically that $|z_1 + z_2| \geq |z_1| + |z_2|$.

8. Shew that, if $|z_1 + z_2 + \dots + z_n| = |z_1| + |z_2| + \dots + |z_n|$, the z 's must all have the same amplitude.

9. Shew that, if $\text{amp} \left\{ \frac{(z_2 - z_3)(z_1 - z_4)}{(z_1 - z_3)(z_2 - z_4)} \right\} = \pi$, then z_3 and z_4 are on opposite sides of the straight line joining z_1 and z_2 , and z_1, z_2, z_3, z_4 , are concyclic.

10. Let A, B, C, and D be the points z_1, z_2, z_3 , and z_4 . Shew that, if $z_1 z_2 + z_3 z_4 = 0$ and $z_1 + z_2 = 0$, then A, B, C, and D are concyclic and the triangles AOC and DOA are similar.

11. If $\overline{AC} : \overline{CB} :: -\overline{AD} : \overline{DB}$, and if A, B, C, D are the points z_1, z_2, z_3, z_4 , shew that A, B, C, and D are concyclic, and prove $(z_1 + z_2)(z_3 + z_4) = 2(z_1 z_2 + z_3 z_4)$: also prove triangles AOC and DOA similar, where O is the mid-point of AB.

12. Prove that the two triangles whose vertices are the points a_1, a_2, a_3 , and b_1, b_2, b_3 , respectively, are directly similar if and only if

$$\begin{vmatrix} a_1 & b_1 & 1 \\ a_2 & b_2 & 1 \\ a_3 & b_3 & 1 \end{vmatrix} = 0.$$

13. Prove that the curves $\left| \frac{z-1}{z+1} \right| = \text{constant}$ and $\text{amp} \left(\frac{z-1}{z+1} \right) = \text{constant}$ are orthogonal circles.

✓ 14. Prove that the imaginary n^{th} roots of a real quantity can be arranged in conjugate pairs.

✓ 15. Picture on a diagram the roots of the equation $z^5 + 1 = 0$.

16. Shew that the equation $32z^5 = (z+1)^5$ has four complex roots, two of which lie in the second quadrant and two in the third. Shew that all the roots lie on a circle.

(See also *Miscellaneous Examples*, 1-9.)

CHAPTER II.

FUNCTIONS OF A COMPLEX VARIABLE.

7. Uniform Functions. When a variable complex quantity w is connected with another variable complex quantity z in such a way that to each value of z there corresponds one value of w , w is said to be a *Uniform* or *Single-valued* function of z . For example, a polynomial in z , or the ratio of two polynomials, is a uniform function of z . The formal definition of a *Holomorphic* function of a complex variable will be given in Chapter III.

The values of z , for which w is a function of z , may be limited to some assigned region of the plane. Thus the equation

$$y = 1 + x + x^2 + \dots,$$

where x is real, defines y as a function of x for those values of x and those alone which satisfy the inequality $-1 < x < 1$.

Multiple-valued Functions. If several values of w correspond to each value of z , w is said to be a *Multiple-valued* or *Multiform* function of z . For example, \sqrt{z} is a two-valued, and $\sqrt[n]{z}$ an n -valued function of z .

Path of Variation. In the theory of functions of a real variable, the independent variable x can only vary by values which correspond to points on the x -axis: in the theory of functions of a complex variable, on the other hand, the independent variable z can vary by values corresponding to the points of any path connecting the initial and final points.

8. Transformations. If w is a function $f(z)$ of z , the relation between w and z may be interpreted geometrically, and the relation may then be called a transformation: the point z is said to be transformed into the corresponding point or points w by means of the transformation $w = f(z)$. If $w = az + b$, the transformation is called a *linear* transformation. If $w = \phi(z)/\psi(z)$,

where $\phi(z)$ and $\psi(z)$ are polynomials, the transformation is said to be *rational*. Transformations of the type $w=(az+b)/(cz+d)$ are known as *bilinear* transformations.

We proceed to investigate the geometrical meaning of linear and bilinear transformations.

I. $w=z+b$. Let P, Q, and B (Fig. 4) be the points z , w , and b . Then, since $\overline{PQ}=\overline{OB}$, it follows that the effect of the transformation is to impose on every point z a translation equivalent in magnitude and direction to OB .

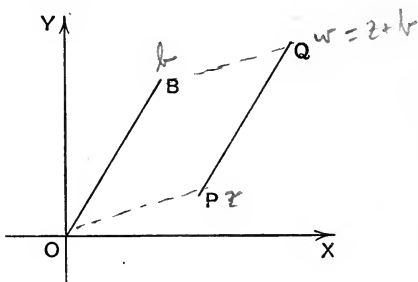

FIG. 4.

II. $w=az$. This transformation gives $|w|=|a|\cdot|z|$, and $\text{amp } w = \text{amp } a + \text{amp } z$.

Consequently, if P and Q are the points z and w , the point Q can be derived from the point P by turning the radius-vector OP through an angle $\text{amp } a$ and then multiplying it by $|a|$. It follows that any figure in the plane is changed by the transformation into a similar figure.

III. $w=az+b$. This, the general linear transformation, can be effected by applying transformations II. and I. in succession. Like transformation II. it transforms any figure in the plane into a similar figure. The ratio of the distances of corresponding points is given by the equation

$$\frac{|w_1 - w_2|}{|z_1 - z_2|} = |a|;$$

and the angle between corresponding lines by the equation

$$\text{amp}(w_1 - w_2) - \text{amp}(z_1 - z_2) = \text{amp } a.$$

IV. $w=1/z$. Here $|w|=1/|z|$, and $\text{amp } w = -\text{amp } z$. Now

let P (Fig. 5) be the point z and P' the inverse of P with regard to the circle $|z|=1$. Then the modulus of P' is $1/|z|$ and its amplitude $\text{amp } z$. Again, let Q be the image of P' in the x -axis; then the modulus of Q is $1/|z|$, and its amplitude is $-\text{amp } z$. Hence Q is the point w . It follows that the transformation is equivalent to an inversion in the circle of unit radius with the origin as centre, followed by a reflection in the x -axis.

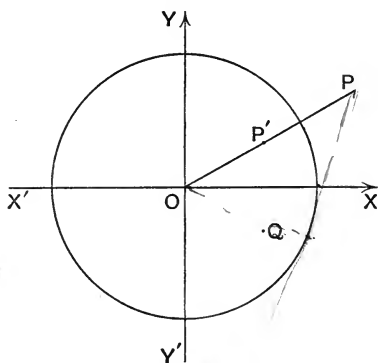

FIG. 5.

Point at Infinity. As z tends to infinity, w approaches the origin. In the theory of the complex variable, infinity is regarded as a point; namely, that point which is related to the origin by means of the transformation $w=1/z$.

V. $w=a/z$. This can be regarded as a combination of transformations IV. and II.

VI. The general bilinear transformation $w=(az+b)/(cz+d)$, where $a/b \neq c/d$. (If $a/b=c/d$, then w is a constant.)

This transformation can be written

$$w = \frac{(bc-ad)/c^2}{z+d/c} + \frac{a}{c}.$$

It can therefore be effected by combining the three transformations $z_1=z+d/c$, $z_2=k/z_1$, where $k=(bc-ad)/c^2$, and $w=z_2+a/c$. It should be noted that z can also be derived from w by the bilinear transformation $z=(-dw+b)/(cw-a)$.

Since the inverse of a circle is a circle or a straight line, it follows that bilinear transformations transform circles into circles or straight lines.

✓ *Example 1.* Apply the transformation $w=(2z+3)/(z-4)$ to the circle $x^2+y^2-4y=0$.

Since $w=2+11/(z-4)$, the transformation can be effected by applying successively the transformations

$$(i) z_1=z-4, \quad (ii) z_2=1/z_1, \quad (iii) z_3=11z_2, \quad \text{and} \quad (iv) w=z_3+2.$$

From transformation (i) we get

$$x=x_1+4, \quad y=y_1.$$

Hence $(x_1+4)^2+y_1^2-4y_1=0$.

Transformation (ii) gives

$$x_1=x_2/(x_2^2+y_2^2), \quad y_1=-y_2/(x_2^2+y_2^2).$$

Therefore $16(x_2^2+y_2^2)+8x_2+4y_2+1=0$.

Again, from transformation (iii),

$$x_2=x_3/11, \quad y_2=y_3/11;$$

so that $16(x_3^2+y_3^2)+88x_3+44y_3+121=0$.

Finally, if $w=u+iv$, transformation (iv) gives

$$x_3=u-2, \quad y_3=v.$$

The given circle is therefore transformed into the circle

$$16u^2+16v^2+24u+44v+9=0.$$

Example 2. Shew that the transformation of *Example 1* changes the circle $x^2+y^2-4x=0$ into the line $4u+3=0$, and explain why the curve obtained is not a circle.

9. Geometrical Representation of Functions. It is often convenient to represent the dependent variable w on a different plane from the independent variable z . This plane is called the w -plane, and $w=u+iv$ is represented on it by the point (u, v) referred to rectangular axes $U'OU, V'OV$. If w is a uniform function $f(z)$ of z , and if z moves from a to b by different paths in the z -plane, w will move from $f(a)$ to $f(b)$ by different paths in the w -plane. In the case of multiple-valued functions, however, it will be shewn that the final point attained in the w -plane depends on which value of w is selected as initial value, and also on the path followed by z in the z -plane.

Example 1. Let $w=z^2$, so that $u=x^2-y^2, v=2xy$.

Then, if $x=0, u=-y^2$ and $v=0$. Hence as z moves up the y -axis from $-\infty$ to $0, u$ increases from $-\infty$ to 0 , and therefore w moves along the u -axis from $-\infty$ to 0 . Again, as z moves up the y -axis from 0 to $+\infty, u$ decreases from 0 to $-\infty$, and therefore w moves back along the u -axis from 0 to $-\infty$.

Similarly, it can be shewn that as z moves along the x -axis from $-\infty$ to $+\infty, v$ passes along the u -axis from $+\infty$ to 0 , and then back from 0 to $+\infty$. Likewise, the positive and negative parts of the v -axis correspond respectively to the lines $y=x$ and $y=-x$.

Again, if we put $z=r(\cos \theta+i \sin \theta)$ and $w=\rho(\cos \phi+i \sin \phi)$, we have
 $\rho=r^2$ and $\phi=2\theta$.

Hence, if z lies on the circle ABCD (Fig. 6) of radius a , w will lie on the circle PQRS of radius a^2 . Let $\theta=0, \phi=0$ initially, so that A and P are the initial positions of z and w . Then as z passes round the quadrant AB in the anti-clockwise direction, θ and ϕ increase to $\pi/2$ and π respectively, so that

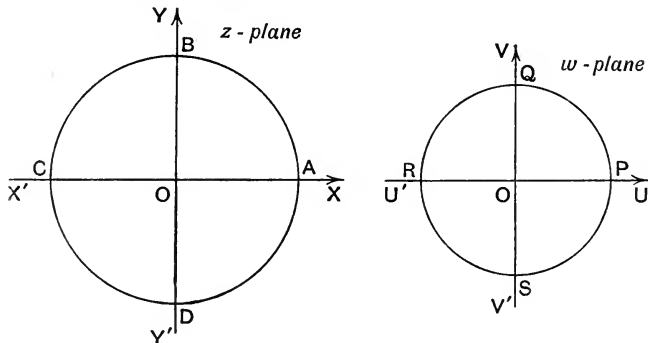

FIG. 6.

w passes round the semi-circle PQR. Similarly, it can be shewn that, as z passes round the quadrants BC, CD and DA, w passes round the semi-circles RSP, PQR and RSP respectively. Thus, when z describes the circle ABCD once, w describes PQRS twice.

✓ *Example 2.* If $w=z^2$, and if z describes the line $x=c$, shew that w describes the parabola $u=c^2-v^2/4c^2$. Trace on a figure, for the particular case $c=1$, the course of w as z moves up the line $x=1$ from $-\infty$ to $+\infty$.

In applications it is often important to trace the change in the amplitude of w when z describes a closed curve. We shall consider some particular cases.

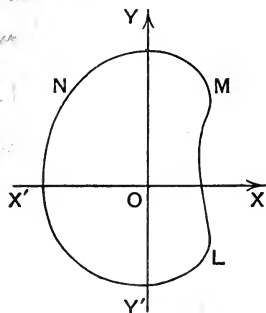

FIG. 7.

(1) $w=z$. Here $\text{amp } w = \text{amp } z$. Let z describe a closed curve LMN (Fig. 7) about the origin. Then, if z passes round LMN

once in the positive direction, $\text{amp } z$, and consequently $\text{amp } w$, will increase by 2π . Similarly, if z passes round the curve once in the negative direction, $\text{amp } z$ and $\text{amp } w$ will each decrease by 2π ; while n successive revolutions in the positive or negative direction will alter the amplitudes by $+2n\pi$ or $-2n\pi$.

Again, if the origin is exterior to the closed curve APBQ (Fig. 8) described by z , the amplitudes of z and w will increase

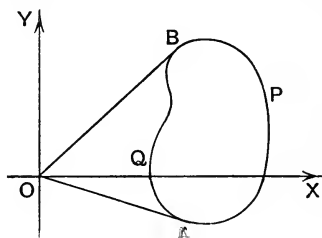

FIG. 8.

from $\angle XOA$ at A to $\angle XOB$ at B, and then decrease from $\angle XOB$ to $\angle XOA$; so that the total change is zero.

(2) $w = a(z - z_1)$, where a and z_1 are constants. Here

$$\text{amp } w = \text{amp } a + \text{amp } (z - z_1);$$

so that, since $\text{amp } a$ is constant, the change in $\text{amp } w$ is equal to the change in $\text{amp } (z - z_1)$. Hence, if z describes a closed curve surrounding z_1 in the positive or negative direction, $\text{amp } w$ will alter by $+2\pi$ or -2π ; while, if z_1 is exterior to the curve, $\text{amp } w$ will return to its original value. In the first case w will describe a closed curve in the w -plane about the origin; while in the second case it will describe a closed curve not enclosing the origin.

(3) $w = a(z - z_1)(z - z_2)(z - z_3)$, where a , z_1 , z_2 , and z_3 are constants.

Here $\text{amp } w = \text{amp } a + \text{amp } (z - z_1) + \text{amp } (z - z_2) + \text{amp } (z - z_3)$.

If z passes round the curve C_0 (Fig. 9), which does not contain any of the points z_1, z_2, z_3 , then $\text{amp } w$ will return to its initial value; so that w will describe a closed curve not enclosing the origin. If z passes round C_1, C_2 , or C_3 , $\text{amp } w$ will be altered by $2\pi, 4\pi$, or 6π , and w will pass round the origin once, twice, or thrice as the case may be.

(4) $w = a(z - z_1)(z - z_2)\dots(z - z_n)$. If in this case z describes a closed curve within which none of the points z_1, z_2, \dots, z_n lies,

it follows, as in cases (2) and (3), that $\text{amp } w$ will regain its initial value, and w will describe a closed curve which does not surround the origin; while, if z describes a closed curve within which r of these points lie, $\text{amp } w$ will be altered by $2r\pi$, and w will pass round the origin r times.

$$(5) \quad w = a(z - z_1)/(z - z_2).$$

Here $\text{amp } w = \text{amp } a + \text{amp } (z - z_1) - \text{amp } (z - z_2)$.

It follows that, if z describes the curve C_1 (Fig. 10) or C_2 in the positive direction, $\text{amp } w$ is increased or decreased by 2π ; while,

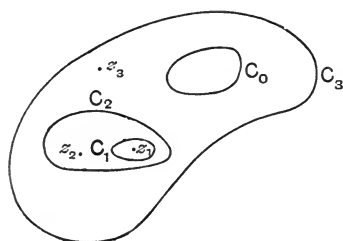

FIG. 9.

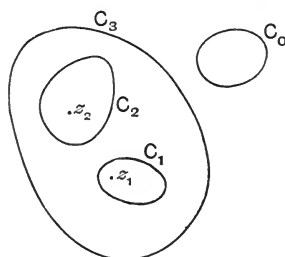

FIG. 10.

if z describes either of the curves C_0 or C_3 , $\text{amp } z$ regains its initial value.

In all these cases it is obvious that the change in $\text{amp } w$ due to the description of any closed curve is independent of the shape of the curve, so long as the same set of points z_1, z_2, z_3, \dots lies inside or outside it. It is often found convenient to take the curve in the form of a circle.

(6) $w = \sqrt{z}$. If $z = r(\cos \theta + i \sin \theta)$, then w has two values,

$$w_1 = r^{1/2} \{ \cos(\theta/2) + i \sin(\theta/2) \}$$

and $w_2 = r^{1/2} \{ \cos(\theta/2 + \pi) + i \sin(\theta/2 + \pi) \} = -w_1$.

Each of these two quantities w_1 and w_2 varies with z , and is therefore a function of z : they are called the *Branches* of the two-valued function w .

Let z start from the point $P(r, \alpha)$ (Fig. 11), and let the initial values of w_1 and w_2 be

$$\bar{w}_1 = r^{1/2} \{ \cos(\alpha/2) + i \sin(\alpha/2) \} \quad \text{and} \quad \bar{w}_2 = -\bar{w}_1.$$

Then \bar{w}_1 and \bar{w}_2 will be represented by the points $P_1(r^{1/2}, \alpha/2)$ and $P_2(r^{1/2}, \alpha/2 + \pi)$ in the w -plane. Now, if z moves round the circle PQR of centre O and radius r , θ will increase by 2π , and

amp w by π . Consequently w_1 will move round the semi-circle $P_1Q_1R_1P_2$ and w_2 round the semi-circle $P_2Q_2R_2P_1$ in the w -plane: the final values of w_1 and w_2 will be \bar{w}_2 and \bar{w}_1 . A revolution of z about the origin therefore interchanges the branches of w . Two such revolutions bring back w_1 and w_2 to their original values; or, graphically expressed, if z moves round the circle PQR twice, w_1 and w_2 each move round the circle $P_1Q_1P_2Q_2$ once.

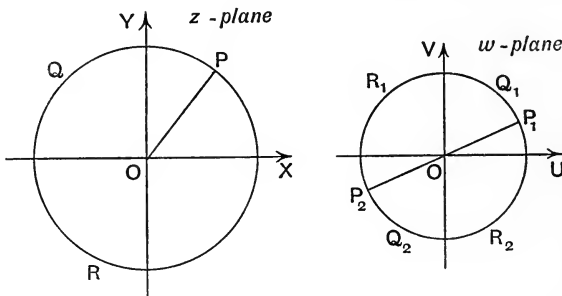

FIG. 11.

If the circuit described by z does not enclose the origin, θ will regain its initial value α , and w_1 and w_2 their initial values \bar{w}_1 and \bar{w}_2 .

The point O is called a *Branch Point* of w , because a circuit about it interchanges the branches of the function.

$$(7) \quad w = \sqrt{a(z-z_1)}. \quad \text{Here amp } w = \frac{1}{2} \text{ amp } a + \frac{1}{2} \text{ amp } (z-z_1).$$

This is again a two-valued function. A single circuit about z_1 interchanges the branches, while a double circuit brings them back to their initial values. On the other hand, the description of a circuit which does not enclose z_1 effects no alteration in the branches. Hence z_1 is a *Branch Point* of w .

$$(8) \quad w = \sqrt{a(z-z_1)(z-z_2)}.$$

$$\text{Here amp } w = \frac{1}{2} \text{ amp } a + \frac{1}{2} \text{ amp } (z-z_1) + \frac{1}{2} \text{ amp } (z-z_2).$$

Hence the description of C_1 (Fig. 12) or C_2 interchanges the branches, while the description of C_0 or C_3 leaves them unaltered. Thus z_1 and z_2 are *Branch Points* of w .

(9) $w = \sqrt[n]{(z-a)}$. If $z-a = r(\cos \theta + i \sin \theta)$, w has n branches w_1, w_2, \dots, w_n , where $w_s = r^{\frac{1}{n}} \left(\cos \frac{\theta + 2s\pi}{n} + i \sin \frac{\theta + 2s\pi}{n} \right)$. A positive circuit round the branch-point a increases θ by 2π , and

therefore changes w_1 into w_2 , w_2 into w_3 , ..., w_n into w_1 . Circuits which do not enclose a leave the branches unaltered.

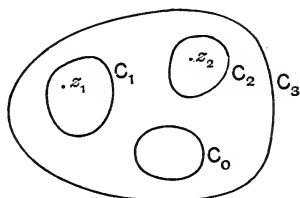

FIG. 12.

Example 3. Let $w = \sqrt{(1-z)(1+z^2)}$, and let the value of w when z is at O be $+1$. Then if z describes the curve OPA (Fig. 13), where A is the point 2 , shew that the value of w at A will be $-i\sqrt{5}$.

The three zeros of w are $1, i$, and $-i$. Let B, C , and D be the corresponding points, and through C and D draw CL and DM parallel to OX .

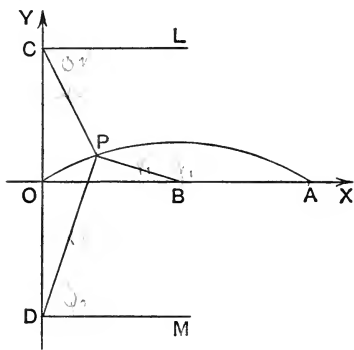

FIG. 13.

Let the moduli and amplitudes of BP, CP , and DP be r_1, r_2, r_3 , and ϕ_1, ϕ_2, ϕ_3 , respectively, where $\angle XBP = \phi_1, \angle LCP = \phi_2$, and $\angle MDP = \phi_3$. Then

$$w = (-1)^{\frac{1}{2}} r_1^{\frac{1}{2}} r_2^{\frac{1}{2}} r_3^{\frac{1}{2}} \left(\cos \frac{\phi_1 + \phi_2 + \phi_3}{2} + i \sin \frac{\phi_1 + \phi_2 + \phi_3}{2} \right).$$

It has still to be determined which of the two possible values $+\pi$ or $-\pi$ is to be assigned to $\text{amp}(-1)$. Now, when z is at $O, \phi_1 = \pi, \phi_2 = -\pi/2, \phi_3 = \pi/2$; so that $\phi_1 + \phi_2 + \phi_3 = \pi$. Hence, if $\text{amp}(-1) = \pi, \text{amp } w = \pi$ at O ; while, if $\text{amp}(-1) = -\pi, \text{amp } w = 0$ at O ; but $w = +1$ when z is at O , so that the latter value must be chosen. Therefore

$$w = r_1^{\frac{1}{2}} r_2^{\frac{1}{2}} r_3^{\frac{1}{2}} \left(\cos \frac{\phi_1 + \phi_2 + \phi_3 - \pi}{2} + i \sin \frac{\phi_1 + \phi_2 + \phi_3 - \pi}{2} \right).$$

Now, as z passes from O to A, ϕ_1 decreases from π to $0, \phi_2$ increases from $-\pi/2$ to $-\tan^{-1}\frac{1}{2}$, and ϕ_3 decreases from $\pi/2$ to $\tan^{-1}\frac{1}{2}$. Therefore at $A \text{amp } w = -\pi/2$; also $r_1 = 1, r_2 = \sqrt{5}, r_3 = \sqrt{5}$. Hence

$$w = \sqrt{5} \{ \cos(-\pi/2) + i \sin(-\pi/2) \} = -i\sqrt{5}.$$

10. Roots of Equations. In works on the theory of equations it is shewn how, by means of Sturm's Theorem, it is possible to find the number of real roots lying between any two real values of the variable. We shall now shew how to find the number of real or complex roots of an equation which are contained in various regions of the z -plane.

Consider the equation

$$f(z) \equiv a_0 z^n + a_1 z^{n-1} + \dots + a_n = 0.$$

We assume that every equation has a root: a proof of this important theorem will be given later (§33). It follows that $f(z)$ can be put in the form

$$a_0(z-z_1)(z-z_2)\dots(z-z_n).$$

If z be taken positively round a closed circuit in the z -plane which encloses r of the points z_1, z_2, \dots, z_n , the amplitude of $f(z)$ will be increased by $2r\pi$. Consequently the number of roots of $f(z)=0$ which lie inside a given circuit can be ascertained by determining the change in the amplitude of $f(z)$ when z passes round the circuit.

The following theorem will be found useful in locating the roots.

THEOREM. If z be taken round any part of a large circle with the origin as centre and radius R , and if θ be the change in

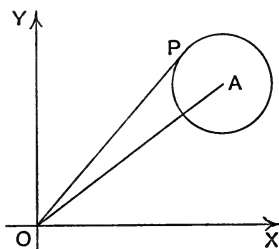

FIG. 14.

amp z , the change in the amplitude of $f(z)$ will differ from $n\theta$ by a quantity which tends to zero as R tends to infinity.

For
$$f(z) = z^n(a_0 + a_1/z + a_2/z^2 + \dots + a_n/z^n).$$

Hence $\text{amp } f(z) = n \text{ amp } z + \text{amp } (a_0 + a_1/z + a_2/z^2 + \dots + a_n/z^n).$

Now
$$|a_1/z + a_2/z^2 + \dots + a_n/z^n| \leq \rho,$$

where
$$\rho = |a_1|/R + |a_2|/R^2 + \dots + |a_n|/R^n.$$

Let R be chosen so large that $\rho < |a_0|$. Then the point $a_0 + a_1/z + \dots + a_n/z^n$ must lie inside a circle of centre a_0 or A

(Fig. 14) and radius ρ . If OP be a tangent to this circle, $\text{amp}(a_0 + a_1/z + \dots + a_n/z^n)$ differs from $\text{amp} a_0$ by an angle η , which is not greater than $\angle AOP$, and which can be made as small as we please by increasing R, and thus decreasing ρ . That is,

$$\text{amp} f(z) = n \text{amp} z + \text{amp} a_0 \pm \eta.$$

Hence $\lim_{R \rightarrow \infty} \text{amp} f(z) = n \text{amp} z + \text{amp} a_0.$

Therefore, when R tends to infinity, the change in $\text{amp} f(z)$ tends to n times the change in $\text{amp} z$.

Example. Investigate the positions of the roots of the equation

$$z^4 + z^3 + 1 = 0.$$

Let $w = z^4 + z^3 + 1$, and let z describe a contour consisting of the three portions:

- (1) the x -axis from 0 to $+\infty$;
- (2) the first quadrant of a circle of centre O and radius infinity;
- (3) the y -axis from $+\infty$ to 0.

(1) At points on the x -axis, $w \equiv u + iv = x^4 + x^3 + 1$, so that $u = x^4 + x^3 + 1$ and $v = 0$. Hence, as z passes along the x -axis from 0 to $+\infty$, w passes along the u -axis from 1 to $+\infty$, and therefore $\text{amp} w$ remains constant and equal to zero.

(2) On the great circle $\text{amp} z$ increases by $\pi/2$, and therefore, by the theorem above, $\text{amp} w$ increases by 2π .

(3) At points on the y -axis, $u = y^4 + 1$ and $v = -y^3$. Hence w lies on the infinite curve LMN (Fig. 15), given by these equations, and as y decreases

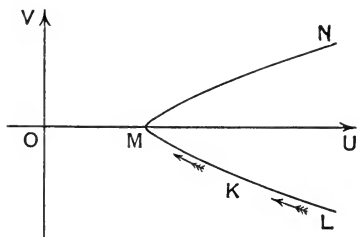

FIG. 15.

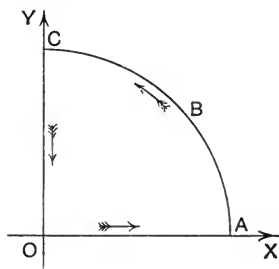

FIG. 16.

from $+\infty$ to 0, w passes along this curve from infinity below the u -axis to the point M ($w=1$) in the direction indicated by the arrows. Hence the initial and final values of $\text{amp} w$ are equal, both being zero.

The total change in $\text{amp} w$ as z passes round the complete circuit is therefore 2π , and it follows that one and only one root of the equation lies in the first quadrant.

Similarly it can be shewn that only one root lies in each of the other quadrants.

Again, let z describe the contour OABCO (Fig. 16), where A and C are the points 1 and i , and ABC is a quadrant of the circle $|z|=1$.

Then, firstly, the description of OA gives rise to no change in amp w .

Next, for points on a circle of centre O and radius R,

$$z = R(\cos \theta + i \sin \theta) = R(1 - t^2 + 2it)/(1 + t^2), \quad \text{where } t = \tan(\theta/2), \\ = R(1 + it)/(1 - it).$$

Accordingly, at points on ABC, $z = (1 + it)/(1 - it)$, so that

$$w = (3 - 12t^2 + t^4 + 2it + 2it^3)/(1 - it)^4.$$

Hence $\text{amp } w = \text{amp} \{(3 - 12t^2 + t^4) + i(2t + 2t^3)\} - \text{amp}(1 - it)^4$.

Now, as θ varies from 0 to $\pi/2$, t varies from 0 to +1; so that $\text{amp}(1 - it)^4$ decreases by $\pi/4$. Hence $\text{amp}(1 - it)^4$ decreases by π .

Again, let $\xi = 3 - 12t^2 + t^4$ and $\eta = 2t + 2t^3$.

Then the curve given by these equations is of the form shewn in Fig. 17,

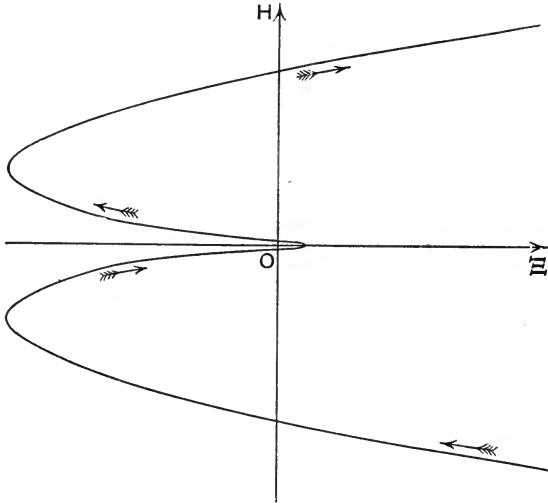

FIG. 17.

the arrows indicating the variation of the point (ξ, η) as t increases from $-\infty$ to $+\infty$.

Now, when $t=0$, $\xi=3$ and $\eta=0$, so that $\text{amp}(\xi + i\eta)=0$; also, when $t=1$, $\xi=-8$ and $\eta=4$, so that $\text{amp}(\xi + i\eta)=\theta$, where θ is the angle in the second quadrant for which $\tan \theta = -1/2$. Hence the change in $\text{amp } w$ due to the description by z of the quadrant ABC is

$$\pi + \theta = 2\pi - \tan^{-1}(1/2).$$

Finally, at points on OC, $u = y^4 + 1$ and $v = -y^2$, so that w lies on the curve LMN (Fig. 15). When $y=1$, w is at the point K($w=2-i$), and

$$\text{amp } w = -\tan^{-1}(1/2); \cdot$$

while, when $y=0$, w is at the point M($w=1$) and $\text{amp } w=0$: so that the change of amplitude due to path CO is $\tan^{-1}(1/2)$.

Hence the total change of amplitude due to the circuit is 2π , and therefore the root which lies in the first quadrant lies within the unit circle.

Similarly it can be shewn that the root in the fourth quadrant lies within the unit circle, while the other two roots lie outside it.

Again, it can be shewn that all the four roots lie inside the circle $|z|=2$.

$$\text{For, if } z = 2(1+it)/(1-it), \\ w = \{(25 - 102t^2 + 9t^4) + i(76t - 44t^3)\}/(1-it)^4.$$

$$\text{Now the curve } \xi = 25 - 102t^2 + 9t^4, \quad \eta = 76t - 44t^3,$$

is of the form shewn in Fig. 18, the arrows indicating the variation of the point (ξ, η) as t increases from $-\infty$ to $+\infty$. But as $\text{amp } z$ varies from $-\pi$

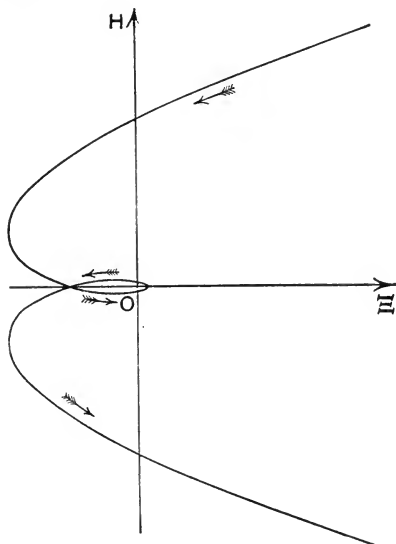

FIG. 18.

to $+\pi$, t varies from $-\infty$ to $+\infty$, and therefore $\text{amp}(\xi + i\eta)$ increases by 4π . Also $\text{amp}\{1/(1-it)^4\}$ increases by 4π . Hence $\text{amp } w$ increases by 8π , and therefore all the four roots lie inside the circle.

EXAMPLES II.

1. If w and z are connected by the bilinear transformation

$$w = (az + b)/(cz + d),$$

and if the points w_1 and w_2 correspond respectively to the points z_1 and z_2 , shew that

$$\frac{w - w_1}{w - w_2} = \frac{cz_2 + d}{cz_1 + d} \frac{z - z_1}{z - z_2}.$$

2. If $w = (az + b)/(cz + d)$, and if the locus of z is an arc of a circle standing on the chord joining the points z_1 and z_2 , shew that the locus of w is an arc of a circle standing on the chord joining w_1 and w_2 .

3. If $w = (az + b)/(cz + d)$, and if the points w_1, w_2, w_3 , and w_4 correspond respectively to z_1, z_2, z_3 , and z_4 , shew that

$$\frac{(w_1 - w_2)(w_3 - w_4)}{(w_1 - w_3)(w_2 - w_4)} = \frac{(z_1 - z_2)(z_3 - z_4)}{(z_1 - z_3)(z_2 - z_4)}.$$

4. Shew that the constants in the transformation $w = (az + b)/(cz + d)$ can be so chosen that three arbitrary points w_1, w_2 , and w_3 correspond respectively to three arbitrary points z_1, z_2 , and z_3 .

5. Find the bilinear transformation which makes the points a, b , and c in the z -plane correspond respectively to the points $0, 1, \infty$ in the w -plane.

$$\text{Ans. } w = \frac{z - a}{z - c} \cdot \frac{b - c}{b - a}.$$

6. Find the bilinear transformation which makes the points $1, i, -1$ in the z -plane correspond respectively to the points $0, 1, \infty$ in the w -plane. Shew that the area of the circle $|z| = 1$ is represented in the w -plane by the half-plane above the real axis.

$$\text{Ans. } w = -i(z - 1)/(z + 1).$$

7. Prove that the relation $w = (1 + iz)/(i + z)$ transforms the part of the real axis between $z = 1$ and $z = -1$ into a semi-circle connecting $w = 1$ and $w = -1$. Also find all the figures which, by successive applications of the relation, can be obtained from the originally selected part of the x -axis.

8. Let $w = \sqrt{2 - 2z + z^2}$, and let z describe a circle of centre $z = 1 + i$ and radius $\sqrt{2}$ in the positive direction. If z starts from O with the value $\sqrt{2}$ of w , what are the values of w

- (i) when z returns to O ;
 (ii) when z crosses the y -axis?

Ans. (i) $-\sqrt{2}$; (ii) $\sqrt[4]{20} \{ \cos(3\pi/8 + \lambda/2) + i \sin(3\pi/8 + \lambda/2) \}$, where λ is the angle in the second quadrant for which $\tan \lambda = -3$.

9. Let $w = \sqrt{5 - 2z + z^2}$, and let z describe a circle of centre $z = 1 + 2i$ and radius 2 in the positive direction. If z starts from the point $+1$ with the value $+2$ of w , find the values of w at the first and second crossings of the y -axis.

Ans. (i) $\sqrt{2} \sqrt[4]{(20 + 8\sqrt{3})} \{ \cos(\pi/3 + \alpha/2) + i \sin(\pi/3 + \alpha/2) \}$, where α is the angle in the second quadrant for which $\tan \alpha = -4 - \sqrt{3}$;
 (ii) $\sqrt{2} \sqrt[4]{(20 - 8\sqrt{3})} \{ \cos(2\pi/3 + \beta/2) + i \sin(2\pi/3 + \beta/2) \}$, where β is the angle in the second quadrant for which $\tan \beta = -4 + \sqrt{3}$.

10. If $w^2 = z + 1$, shew that, when the point z describes the circle $|z| = c$, each of the points w describes the Cassinian $r_1 r_2 = c$, where r_1 and r_2 are the distances of w from the points $+1$ and -1 .

11. Shew that the equation $z^4 + z + 1 = 0$ has one root in each quadrant, and that the root belonging to the first quadrant lies outside the circle $|z| = 1$ and inside the circle $|z| = 2$.

12. Shew that the root of $z^4 + z + 1 = 0$ belonging to the first quadrant lies inside the square whose sides are $x = 0, x = 1, y = 0$, and $y = 1$.

13. Shew that the equation $z^4 + 4(1 + i)z + 1 = 0$ has one root in each quadrant.

14. Shew that two of the roots of the equation $z^5 - z + 16 = 0$ have their real parts positive, and three their real parts negative. Also shew that all five roots lie outside the circle $|z|=1$ and inside the circle $|z|=2$.

15. Shew that the only root of $z^5 + 10z - 1 = 0$ inside the circle $|z|=1$ is real and positive.

16. Prove that $z^5 + 10z - 1 = 0$ has no root the modulus of which exceeds 2.

17. If $w = \{(2+i)z + (3+4i)\}/z$, shew that :

(i) as (x, y) describes the circle $x^2 + y^2 = 1$ positively, the point (u, v) describes the circle $(u-2)^2 + (v-1)^2 = 25$ negatively ;

(ii) as (x, y) describes the circle $x^2 + y^2 - 4x - 6y - 12 = 0$ positively, the point (u, v) describes the circle $(u-1/2)^2 + (v-13/12)^2 = (25/12)^2$ negatively.

18. Apply the transformation $w=1/z$, (i) to the set of straight lines through the point $(a, 0)$, and (ii) to the set of circles with this point as centre : and shew that the set (i) is transformed into a set of coaxial circles through the points $w=0, w=1/a$, while the set (ii) is transformed into a set of coaxial circles, of which these two points are the limiting points.

CHAPTER III.

HOLOMORPHIC FUNCTIONS.

11. Limits. A single-valued function $f(z)$ is said to tend to the limit L as z tends to the value z_1 if, corresponding to any assigned positive quantity ϵ , however small, a positive quantity η can be found such that $|f(z) - L| < \epsilon$ for all values of z (except z_1) which satisfy the inequality $|z - z_1| < \eta$. For brevity we write

$$\lim_{z \rightarrow z_1} f(z) = L.$$

This condition can be represented geometrically as follows: if γ (Fig. 19) be a circle in the w -plane of centre L and assigned radius ϵ , a positive

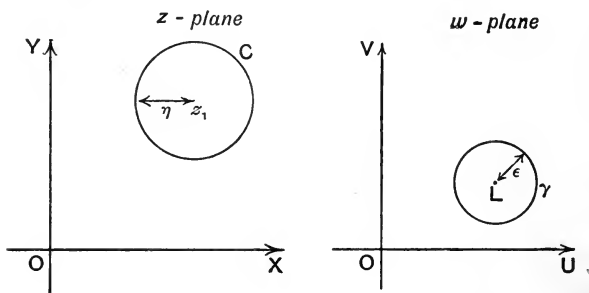

FIG. 19.

quantity η can be found such that, so long as z remains inside the circle C in the z -plane of centre z_1 and radius η , the corresponding point $f(z)$ in the w -plane will remain inside the circle γ .

The limit L is clearly independent of the path by which z approaches z_1 .

The limit L has not necessarily the same value as $f(z_1)$: for, consistently with the definitions of § 7, any arbitrary value can be assigned to the function at the point z_1 .

Limit at Infinity. If, corresponding to any positive quantity ϵ , however small, a positive number N can be found such that

$|f(z) - L| < \epsilon$ for $|z| > N$, $f(z)$ is said to tend to the limit L as z tends to infinity: that is, $\lim_{z \rightarrow \infty} f(z) = L$.

Example. $\lim_{z \rightarrow \infty} 1/z = 0$.

Infinite Limits. If, corresponding to any positive number N , however large, a positive number η can be found such that $|f(z)| > N$ for $|z - z_1| < \eta$, $f(z)$ is said to tend to the limit infinity as z tends to z_1 .

Example. $\lim_{z \rightarrow 0} 1/z = \infty$.

The branches of multiple-valued functions generally tend to different limits as z tends to z_1 .

If the limit L is a function $L(z_1)$ of z_1 , and if an η can be found such that, for all points z_1 in a given region, $|f(z) - L(z_1)| < \epsilon$ provided $|z - z_1| < \eta$, $f(z)$ is said to tend *uniformly* to the limit $L(z_1)$ in the region.

12. Continuity. The function $f(z)$ is said to be continuous at z_1 if $f(z_1)$ has a definite value, and if $\lim_{z \rightarrow z_1} f(z) = f(z_1)$.

If $f(z_1)$ is infinite, $f(z)$ has not a definite value, and is therefore discontinuous at the point z_1 .

The condition for continuity can be expressed as follows: if, corresponding to any ϵ ,* an η * can be found such that

$$|f(z) - f(z_1)| < \epsilon \quad \text{for} \quad |z - z_1| < \eta,$$

$f(z)$ is continuous at z_1 .

A function is continuous in a region, if it is continuous at all points of the region.

If $f(z)$ has a definite limit at z_1 different from $f(z_1)$, $f(z)$ is said to have a *Removable Discontinuity* at z_1 , and the function can be made continuous by replacing the value at z_1 by the limit at that point.

To investigate the continuity of a function at infinity, put $z = 1/\zeta$, and test for $\zeta = 0$.

THEOREM 1. The sum of a finite number of continuous functions is a continuous function.

*In this book ϵ will usually be understood to represent an arbitrarily small positive quantity, and η a positive quantity.

THEOREM 2. The product of a finite number of continuous functions is a continuous function.

THEOREM 3. The ratio of two continuous functions is continuous except for values of z which make the divisor zero.

The verification of these three theorems is left to the reader. The proofs are almost identical with those for functions of a real variable.

THEOREM 4. If $f(z)$ is continuous and has the value l at z_1 , and if $\phi(z)$ is continuous at l , $\phi\{f(z)\}$ is continuous at z_1 .

For, $|f(z)-l|<\epsilon$, if $|z-z_1|<\eta$; and ϵ can be chosen so that $|\phi(\xi)-\phi(l)|<\epsilon'$, if $|\xi-l|<\epsilon$. Now let $\xi=f(z)$; then

$$|\phi\{f(z)\}-\phi\{f(z_1)\}|<\epsilon',$$

provided $|z-z_1|<\eta$. Hence $\phi\{f(z)\}$ is continuous at $z=z_1$.

THEOREM 5. The real and imaginary parts of continuous functions are continuous functions.

For, if $w=u+iv$ is continuous at $z=z_1$, and if its value at that point is $w_1=u_1+iv_1$, an η can be found such that, for $|z-z_1|<\eta$,

$$|w-w_1|=|(u-u_1)+i(v-v_1)|<\epsilon.$$

$$\text{Thus} \quad \sqrt{\{(u-u_1)^2+(v-v_1)^2\}}<\epsilon;$$

$$\text{so that} \quad |u-u_1|<\epsilon, \quad |v-v_1|<\epsilon.$$

Hence u and v are continuous functions at $z=z_1$.

13. Uniform Continuity. A function $f(z)$ is said to be *Uniformly Continuous* in a given region, if, corresponding to any ϵ , an η can be found such that, for every point z_1 in the region, $|f(z)-f(z_1)|<\epsilon$, when $|z-z_1|<\eta$; i.e. if $f(z)$ tends uniformly to $f(z_1)$ in the region.

THEOREM. If $f(z)$ is continuous in a given region, it is uniformly continuous in that region.

The proof of this theorem depends on the following Lemma:

Lemma. If $|f(z)-f(z_1)|<\epsilon$ for $|z-z_1|<\eta$, then

$$|f(z)-f(z_2)|<2\epsilon \quad \text{for} \quad |z-z_2|<\frac{1}{2}\eta,$$

where z_2 is any point interior to the circle $|z-z_1|=\frac{1}{2}\eta$.

Let C_1 (Fig. 20) and C_2 be the circles $|z - z_1| = \eta$ and $|z - z_1| = \frac{1}{2}\eta$. Then, if z and z_2 lie within C_1 ,

$$\begin{aligned} |f(z) - f(z_2)| &= |f(z) - f(z_1) + f(z_1) - f(z_2)| \\ &\leq |f(z) - f(z_1)| + |f(z_2) - f(z_1)| \\ &< 2\epsilon. \end{aligned}$$

But if z_2 be restricted to lie within C_2 , every point z such that $|z - z_2| < \frac{1}{2}\eta$ will lie within C_1 . Hence the Lemma holds.

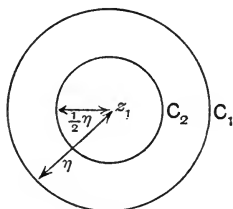

FIG. 20.

Now suppose that $f(z)$ is not uniformly continuous in a region within which it is continuous. Divide the region into smaller regions by means of sets of equidistant lines parallel to the two axes. In one, at least, of these smaller regions $f(z)$ is not uniformly continuous. Divide this smaller region into still smaller regions in the same way as before. In at least one of these regions $f(z)$ is not uniformly continuous. By continuing this process a series of rectangular regions is obtained, each of which is contained in the preceding one, and is a region of non-uniform continuity. Now let z_1 be a point interior to all the regions of this series; then, since $f(z)$ is continuous at z_1 , an η can be found such that $|f(z) - f(z_1)| < \epsilon/2$, provided $|z - z_1| < \eta$. Hence, by the Lemma above, $|f(z) - f(z_2)| < \epsilon$ for $|z - z_2| < \frac{1}{2}\eta$, where z_2 is interior to the circle $|z - z_1| = \frac{1}{2}\eta$; so that this circle is a region of uniform continuity of the function. But if the subdivision of the given region be continued till a region of the series obtained above is reached which lies entirely within this circle, this rectangle is a region of non-uniform continuity for $f(z)$. Also, since the rectangle lies within the circle, it is a region of uniform continuity for $f(z)$. Thus two mutually contradictory results are obtained. Hence $f(z)$ must be uniformly continuous in the given region.

Functions of Two Real Variables. A function $u(x, y)$ of x and y is said to be uniformly continuous in a given region if, corresponding to any ϵ , an η can be found such that, for every point (x, y) in the region,

$$|u(x + \Delta x, y + \Delta y) - u(x, y)| < \epsilon,$$

provided $|\Delta x| < \eta$, $|\Delta y| < \eta$. A function $u(x, y)$ which is continuous in a given region is also uniformly continuous in the region. The proof of this theorem is left as an exercise to the reader.

Again, let the continuous function $u(x, y)$ have continuous partial derivatives of the first order in the region. Then, if

$$\begin{aligned} \Delta u &= u(x + \Delta x, y + \Delta y) - u(x, y), \\ \Delta u &= \{u(x + \Delta x, y + \Delta y) - u(x, y + \Delta y)\} \\ &\quad + \{u(x, y + \Delta y) - u(x, y)\} \\ &= \Delta x \frac{\partial}{\partial x} u(x + \theta_1 \Delta x, y + \Delta y) + \Delta y \frac{\partial}{\partial y} u(x, y + \theta_2 \Delta y), \end{aligned}$$

where $0 < \theta_1 < 1$, $0 < \theta_2 < 1$.

Now $\frac{\partial u}{\partial x}$ and $\frac{\partial u}{\partial y}$ are continuous in the given region, and therefore, from the property of uniform convergence,

$$\begin{aligned} \frac{\partial}{\partial x} u(x + \theta_1 \Delta x, y + \Delta y) &= \frac{\partial u(x, y)}{\partial x} + \alpha, \\ \frac{\partial}{\partial y} u(x, y + \theta_2 \Delta y) &= \frac{\partial u(x, y)}{\partial y} + \beta, \end{aligned}$$

where $|\alpha| < \epsilon$, $|\beta| < \epsilon$, provided $|\Delta x| < \eta$, $|\Delta y| < \eta$.

$$\text{Hence} \quad \Delta u = \frac{\partial u}{\partial x} \Delta x + \frac{\partial u}{\partial y} \Delta y + \alpha \Delta x + \beta \Delta y,$$

where α and β tend uniformly to zero with Δx and Δy at all points in the given region.

14. Differentiation. The *Derivative* of any function $f(z)$, obtained by applying a finite number of the algebraical operations considered in §§ 4, 5, and 6 to z in succession, is

$$\text{Lim}_{\Delta z \rightarrow 0} \frac{f(z + \Delta z) - f(z)}{\Delta z}.$$

These limits are obtained by the same rules as when the independent variable is real. It is important to notice that the value of the derivative is independent of the amplitude of Δz .

Example 1. Prove $\frac{dz^n}{dz} = nz^{n-1}$, (i) for n a positive integer, and (ii) for n a negative integer.

Example 2. Prove $\frac{dz^n}{dz} = nz^{n-1}$ for n a positive fraction.

Let $n = p/q$, where p and q are positive integers; then, if

$$z = r(\cos \theta + i \sin \theta),$$

$$z^{\frac{1}{q}} = r^{\frac{1}{q}} \left(\cos \frac{\theta + 2k\pi}{q} + i \sin \frac{\theta + 2k\pi}{q} \right), \quad \text{where } k = 0, 1, 2, \dots, q-1.$$

Now let $\zeta = z^{1/q}$, where ζ represents the branch of $z^{1/q}$ corresponding to one particular value of k .

Then, if the increment Δz of z correspond to the increment $\Delta \zeta$ of ζ ,

$$\frac{(z + \Delta z)^{p/q} - z^{p/q}}{\Delta z} = \frac{(\zeta + \Delta \zeta)^p - \zeta^p}{(\zeta + \Delta \zeta)^q - \zeta^q}.$$

Hence
$$\frac{dz^{p/q}}{dz} = \frac{p\zeta^{p-1}}{q\zeta^{q-1}} = \frac{p}{q} \zeta^{p-q} = \frac{p}{q} z^{\frac{p}{q}-1},$$

where the same value of $z^{1/q}$ is taken on both sides of the equation.

Example 3. Prove $\frac{dz^n}{dz} = nz^{n-1}$ for n a negative fraction.

15. Holomorphic Functions. Any function of x and y can be regarded, according to the definition of § 7, as a function of z : for if z be given, the corresponding values of x and y are known, and therefore the corresponding values of the function can be found. For example, one value of $x - iy$ or of $x^2 - y^2$ corresponds to every value of z . But these functions cannot be expressed in terms of z , and it is much more satisfactory to regard them as functions of the two independent variables x and y .

Let $w = u + iv$, where u and v are real functions of x and y . Then, if $z' = x - iy$, $x = (z + z')/2$ and $y = (z - z')/2i$; so that u and v can be regarded as functions of the independent variables z and z' . Hence, if u and v are continuous functions of x and y with continuous partial derivatives, the condition that w should be independent of z' is

$$\frac{\partial u}{\partial x} \frac{\partial x}{\partial z'} + \frac{\partial u}{\partial y} \frac{\partial y}{\partial z'} + i \frac{\partial v}{\partial x} \frac{\partial x}{\partial z'} + i \frac{\partial v}{\partial y} \frac{\partial y}{\partial z'} = 0,$$

or
$$\frac{\partial u}{\partial x} \frac{1}{2} - \frac{\partial u}{\partial y} \frac{1}{2i} + i \frac{\partial v}{\partial x} \frac{1}{2} - i \frac{\partial v}{\partial y} \frac{1}{2i} = 0;$$

and this is equivalent to the two equations

$$\frac{\partial u}{\partial x} = \frac{\partial v}{\partial y}, \quad \frac{\partial u}{\partial y} = -\frac{\partial v}{\partial x}. \tag{A}$$

Thus, if u and v are continuous, and possess continuous partial derivatives which satisfy equations (A), w is a function of x and y in which x and y occur only in the combination $x + iy = z$; it may therefore be expected that the function w , like the functions considered in § 14, will have a derivative which does not depend at all on the way in which Δx and Δy tend to zero, *i.e.* which does not depend upon $\frac{dy}{dx}$. It will be shewn in the following theorem that this is the case.

THEOREM. If $w = u + iv$, where u and v are uniform continuous functions which possess continuous partial derivatives, the necessary and sufficient condition that w should possess a definite continuous derivative is that these partial derivatives should satisfy equations (A).

Let the increments Δw , Δu , Δv , and Δz , of w , u , v , and z , correspond to the increments Δx and Δy of x and y . Then

$$\begin{aligned} \frac{\Delta w}{\Delta z} &= \frac{\Delta u + i\Delta v}{\Delta x + i\Delta y} \\ &= \frac{\left(\frac{\partial u}{\partial x}\Delta x + \frac{\partial u}{\partial y}\Delta y + \alpha\Delta x + \beta\Delta y\right) + i\left(\frac{\partial v}{\partial x}\Delta x + \frac{\partial v}{\partial y}\Delta y + \alpha'\Delta x + \beta'\Delta y\right)}{\Delta x + i\Delta y} \\ &= \frac{\left(\frac{\partial u}{\partial x} + i\frac{\partial v}{\partial x}\right) + \left(\frac{\partial u}{\partial y} + i\frac{\partial v}{\partial y}\right)\frac{\Delta y}{\Delta x} + (\alpha + i\alpha') + (\beta + i\beta')\frac{\Delta y}{\Delta x}}{1 + i\frac{\Delta y}{\Delta x}}, \end{aligned}$$

where $\alpha, \beta, \alpha', \beta'$, tend uniformly to zero with Δx and Δy . Thus

$$\frac{dw}{dz} = \lim_{\Delta z \rightarrow 0} \frac{\Delta w}{\Delta z} = \frac{\left(\frac{\partial u}{\partial x} + i\frac{\partial v}{\partial x}\right) + \left(\frac{\partial u}{\partial y} + i\frac{\partial v}{\partial y}\right)\frac{dy}{dx}}{1 + i\frac{dy}{dx}}.$$

Hence the necessary and sufficient condition that $\frac{dw}{dz}$ should be independent of $\frac{dy}{dx}$ is

$$\frac{\partial u}{\partial x} + i\frac{\partial v}{\partial x} = \frac{1}{i}\left(\frac{\partial u}{\partial y} + i\frac{\partial v}{\partial y}\right),$$

which is equivalent to equations (A).

$$\text{COROLLARY 1. } \frac{dw}{dz} = \frac{\partial w}{\partial x} = \frac{1}{i} \frac{\partial w}{\partial y}.$$

COROLLARY 2. Since the partial derivatives of u and v are continuous, $\frac{dw}{dz}$ is also continuous.

Definition. If a function is uniform and continuous, and possesses a definite continuous derivative at any point, it is said to be *Holomorphic** at the point.

A function is said to be *Holomorphic* in a given region, if it is holomorphic at all points of the region.

Equations (A), expressed in terms of polar coordinates, become

$$\frac{\partial u}{\partial r} = \frac{1}{r} \frac{\partial v}{\partial \theta}, \quad \frac{1}{r} \frac{\partial u}{\partial \theta} = -\frac{\partial v}{\partial r}; \quad (\text{A}')$$

and the derivative is then obtained as follows:

$$\begin{aligned} \frac{dw}{dz} &= \frac{\partial w}{\partial x} = \frac{\partial w}{\partial r} \frac{\partial r}{\partial x} + \frac{\partial w}{\partial \theta} \frac{\partial \theta}{\partial x} \\ &= \frac{\partial w}{\partial r} \cos \theta - \left(-r \frac{\partial v}{\partial r} + ir \frac{\partial u}{\partial r} \right) \frac{\sin \theta}{r} \\ &= (\cos \theta - i \sin \theta) \frac{\partial w}{\partial r}. \end{aligned}$$

Example 1. Shew that the function $e^x(\cos y + i \sin y)$ is holomorphic, and find its derivative.

Ans. $e^x(\cos y + i \sin y)$.

Example 2. Shew that $\log r + i\theta$ is holomorphic unless $r=0$, and find its derivative.

Ans. $(\cos \theta - i \sin \theta)/r$.

Note. From the definition of a derivative the rules for differentiating products and quotients follow as in the case of the real variable.

THEOREM. If $f(z)$ is holomorphic in a given region, then, for all points z_1 in the region,

$$f(z) = f(z_1) + (z - z_1)f'(z_1) + (z - z_1)\lambda,$$

where λ tends uniformly to zero as z tends to z_1 .

The proof of this theorem is left as an exercise to the reader.

*The words *Regular* and *Analytic* are used by some writers instead of *Holomorphic*. The sense in which we shall use the word *Analytic* will be explained in Chapter XII. § 82.

COROLLARY. If $f(z)$ and $\phi(z)$ are holomorphic, and if $f(z_1)=0$, and $\phi(z_1)=0$, while $\phi'(z_1)\neq 0$,

$$\lim_{z \rightarrow z_1} \frac{f(z)}{\phi(z)} = \frac{f'(z_1)}{\phi'(z_1)}.$$

Function of a Function. If $w=f(\xi)$ and $\xi=\phi(z)$ are holomorphic functions of ξ and z respectively, w is a holomorphic function of z ; for $\frac{dw}{dz} = \frac{dw}{d\xi} \frac{d\xi}{dz}$.

Simply-Connected Regions. If any two points in a region can be connected by a curve which lies entirely within the region, the region is said to be *Connected*. A connected region which is such that any closed curve lying entirely within it can be contracted to a point without passing out of the region is said to be *Simply-Connected*. Connected regions which are not simply-connected are said to be *Multiply-Connected*. The region enclosed by the curve C_1 (Fig. 21) is simply-connected, while the region between the curves C_1 and C_2 is multiply-connected.

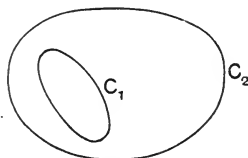

FIG. 21.

The branches of multiple-valued functions can be treated as uniform functions in simply-connected regions which do not enclose any branch-points. No path in such a region can enclose a branch-point; so that, after describing a closed path, the function regains its initial value. For example, each branch of $w=\sqrt{z}$ is holomorphic in the simply-connected region obtained by making the negative real axis a barrier which z cannot pass. Such a barrier is called a *Cross-cut*. The derivative $1/(2\sqrt{z})$, of course, takes the value corresponding to the value of \sqrt{z} under consideration.

Inverse Functions. If $w=f(z)$ is a holomorphic function such that $w=w_1$ corresponds to $z=z_1$, z can be regarded as a function of w with z_1 corresponding to w_1 : if this function is uniform and continuous in a region of the w -plane which encloses w_1 ,

then, since $\frac{dz}{dw} = 1 \left/ \frac{dw}{dz} \right.$, it is a holomorphic function of w at all points of the region except those for which $\frac{dw}{dz} = 0$. This function is called the *Inverse Function* of $f(z)$.

Example 1. If $w = z^2$, there corresponds to any value z_1 of z one value w_1 of w : conversely, one of the branches of $z = \sqrt{w}$ gives the value z_1 of z corresponding to $w = w_1$. Now the only value of w for which $\frac{dw}{dz} = 0$ is $w = 0$. Hence, if $w_1 \neq 0$, w_1 can be enclosed in a region in which the branch is holomorphic, and therefore $z = \sqrt{w}$ is the inverse function of $w = z^2$.

Example 2. For what values of z do the functions w defined by the following equations cease to be holomorphic?

$$(1) z = e^u(\cos v + i \sin v);$$

$$(2) z = \log \rho + i\phi, \text{ where } w = \rho(\cos \phi + i \sin \phi).$$

Ans. (1) $z = 0$; (2) None.

Laplace's Equation. It will be proved later (§35) that if $w = u + iv$ is a holomorphic function, w , u , and v have continuous derivatives of the second and higher orders. The reader can easily verify that u and v both satisfy Laplace's Equation

$$\frac{\partial^2 V}{\partial x^2} + \frac{\partial^2 V}{\partial y^2} = 0.$$

The solutions of this equation are called *Harmonic Functions*, and are of great importance in Mathematical Physics.

It follows that, if a function u or v is given, a corresponding holomorphic function w will not exist unless the given function is harmonic. If, however, this condition is fulfilled, the function w can be found by means of equations (A): for example, if u is a uniform continuous function which satisfies Laplace's Equation,

$$dv = \frac{\partial v}{\partial x} dx + \frac{\partial v}{\partial y} dy = -\frac{\partial u}{\partial y} dx + \frac{\partial u}{\partial x} dy$$

is a complete differential, and v can therefore be found.

Example. Shew that $u = x^3 - 3xy^2 + 3x^2 - 3y^2 + 1$ is a harmonic function, and find the corresponding holomorphic function.

Ans. $z^3 + 3z^2 + 1 + iC$, where C is a real constant.

Conjugate Functions. If $u + iv$ is holomorphic, u and v are called *Conjugate Functions*. These functions possess two important properties: firstly, they satisfy Laplace's Equation; and secondly, the curves $u = c_1$, $v = c_2$, where c_1 and c_2 are arbitrary constants, intersect at right angles, since the product of their

gradients $-\left(\frac{\partial u}{\partial x} \middle| \frac{\partial u}{\partial y}\right)$ and $-\left(\frac{\partial v}{\partial x} \middle| \frac{\partial v}{\partial y}\right)$ is -1 . The systems of curves obtained by varying the constants c_1 and c_2 are called *Orthogonal Systems*.

Example. Picture on a diagram the orthogonal systems given by
 $w = \log r + i\theta$.

16. The Exponential Function. The function $u + iv$, where

$$u + iv = e^x(\cos y + i \sin y)$$

is holomorphic for all finite values of z , since u, v satisfy equations (A), § 15. When y is zero, the function becomes the ordinary exponential function e^x : it is therefore regarded as the extension of e^x to the domain of the complex variable, and is denoted by $\exp(z)$. Obviously

$$|\exp z| = e^x, \quad \text{amp}(\exp z) = y.$$

Again, since

$$\begin{aligned} e^x(\cos y + i \sin y) \times e^{x'}(\cos y' + i \sin y') \\ = e^{x+x'}\{\cos(y+y') + i \sin(y+y')\}, \\ \exp(z) \times \exp(z') = \exp(z+z'). \end{aligned}$$

Hence

$$\exp(z) \times \exp(-z) = \exp(0) = 1;$$

so that

$$\exp(-z) = 1/\exp(z).$$

Thus, $\exp(z)$ satisfies the index laws. It is often found convenient to write e^z for $\exp(z)$: in particular, e^{iy} stands for $\cos y + i \sin y$.

Derivative. $\frac{d}{dz}(\exp z) = \frac{\partial}{\partial x}\{e^x(\cos y + i \sin y)\} = \exp z,$

or

$$\frac{de^z}{dz} = e^z.$$

Periodicity. Since $\cos y$ and $\sin y$ have the period 2π , $\exp(z)$ has the period $2i\pi$: i.e.

$$e^{z+2ki\pi} = e^z(\cos 2k\pi + i \sin 2k\pi) = e^z,$$

where k is any integer.

Zeros and Infinities. Since $|e^z| = e^x$, e^z can only have zero and infinite values when e^x is zero or infinite. But e^x is only zero when $x = -\infty$, and only infinite when $x = +\infty$. The Exponential Function is therefore finite and non-zero if x is finite.

Example. Shew that every period of $\exp(z)$ must be an integral multiple of $2i\pi$.

17. The Circular Functions. Since $e^{ix} = \cos x + i \sin x$ and $e^{-ix} = \cos x - i \sin x$,

$$\cos x = \frac{e^{ix} + e^{-ix}}{2}, \quad \sin x = \frac{e^{ix} - e^{-ix}}{2i}.$$

These functions can therefore be extended to the domain of the complex variable by means of the equations

$$\cos z = \frac{e^{iz} + e^{-iz}}{2}, \quad \sin z = \frac{e^{iz} - e^{-iz}}{2i},$$

which define them as holomorphic functions.

The following well-known formulae can be derived from these definitions:

$$\sin^2 z + \cos^2 z = 1;$$

$$\sin(z_1 + z_2) = \sin z_1 \cos z_2 + \cos z_1 \sin z_2;$$

$$\cos(z_1 + z_2) = \cos z_1 \cos z_2 - \sin z_1 \sin z_2;$$

$$\frac{d \sin z}{dz} = \cos z; \quad \frac{d \cos z}{dz} = -\sin z;$$

$$\sin(-z) = -\sin z; \quad \cos(-z) = \cos z.$$

Note. If $f(-z) = -f(z)$ for all values of z for which $f(z)$ is defined, $f(z)$ is said to be an odd function of z : if $f(-z) = f(z)$, $f(z)$ is an even function of z . Thus, $\sin z$ and $\cos z$ are odd and even functions respectively.

Zeros. If $\sin z = 0$,

$$e^{iz} = e^{-iz} = e^{-iz + 2k\pi i},$$

where k is any integer; therefore $iz = -iz + 2k\pi i$.

Hence the values of z which make $\sin z$ zero are $0, \pm\pi, \pm 2\pi, \pm 3\pi, \dots$

Similarly, since $-e^{-iz} = e^{-iz + (2k+1)\pi i}$, the values of z which make $\cos z$ zero are given by $z = (k + \frac{1}{2})\pi$, where $k = 0, \pm 1, \pm 2, \dots$

The other circular functions are defined by means of $\sin z$ and $\cos z$: e.g. $\tan z = \sin z / \cos z$. The inverse functions are written $\sin^{-1}z, \tan^{-1}z$, etc.

The Hyperbolic Functions. These functions are defined by the equations:

$$\cosh z = \frac{e^z + e^{-z}}{2}; \quad \sinh z = \frac{e^z - e^{-z}}{2}; \quad \tanh z = \frac{\sinh z}{\cosh z}; \quad \text{etc.}$$

Example. Prove: $\frac{d \sinh z}{dz} = \cosh z$; $\frac{d \cosh z}{dz} = \sinh z$; $\cosh^2 z - \sinh^2 z = 1$.

18. The Logarithmic Function. If $y=e^x$, where x and y are real, the inverse function is $x=\log y$: for complex values of the variables, the inverse of the Exponential Function is defined as follows:

Let $z=r(\cos \theta+i \sin \theta)=\exp (w)=e^u(\cos v+i \sin v)$.

Then $e^u=r$, so that $u=\log r$ and $v=\theta+2k\pi$, where k is any integer. Hence the inverse function is

$$w=\log r+i\theta,$$

where θ may have an infinite number of values differing by multiples of 2π . This function is denoted by $\text{Log } z$.

If z passes round the origin once in the positive direction, θ increases by 2π and $\text{Log } z$ by $2i\pi$. The origin is therefore a branch-point of $\text{Log } z$. Each of the infinite number of branches of $\text{Log } z$ is uniform and continuous in the simply-connected region formed by taking a cross-cut along the negative real axis; and therefore, since it satisfies equations (A') of §15, it is holomorphic in that region. That branch for which $-\pi < \theta \leq +\pi$ is denoted by $\log z$; for positive real values of z this branch is the ordinary Napierian logarithm.

Zeros and Infinities. Since $\log r$ is infinite when r is zero or infinite, $\text{Log } z$ has infinities at the origin and infinity. $\text{Log } z$ is only zero when both $\log r$ and θ are zero; i.e. when $z=1$.

Derivative.
$$\frac{d \text{Log } z}{dz} = e^{-i\theta} \frac{\partial}{\partial r} (\log r + i\theta) = \frac{\partial}{\partial r} (\log r + i\theta) \cdot \frac{\partial r}{\partial z}$$

$$= \frac{1}{r e^{i\theta}} = \frac{1}{z}.$$

Handwritten note: $z = r e^{i\theta}$

Example. Shew that $\text{Log}(zz') = \log z + \log z' + 2k\pi i$.

The Function $\tan^{-1}z$. If $z = \tan w = \frac{1}{i} \frac{e^{iw} - e^{-iw}}{e^{iw} + e^{-iw}}$, then

$$\frac{1+iz}{1-iz} = e^{2iw};$$

so that $w = \frac{1}{2i} \text{Log } \zeta$, where $\zeta = \frac{1+iz}{1-iz}$. Now $\text{Log } \zeta$ is uniform if a cross-cut is taken in the ζ -plane* along the negative real axis. But the transformation $\zeta = (1+iz)/(1-iz)$ is bilinear, so that one point in the ζ -plane corresponds to each point in the z -plane,

* The notation $\zeta = \xi + i\eta$ is adopted; ξ, η, ζ , then correspond to x, y, z .

and conversely. Accordingly, if a cross-cut be taken in the z -plane corresponding to the cross-cut in the ξ -plane, the function $\text{Log } \xi$ will be uniform in the z -plane. Now, since

$$z = i(1 - \xi)/(1 + \xi),$$

to the part of the ξ -axis between 0 and -1 corresponds the y -axis from i to $+i\infty$, while to the ξ -axis from -1 to $-\infty$ corresponds the y -axis from $-i\infty$ to $-i$. Hence, if a cross-cut is taken along these parts of the y -axis, the function

$$\tan^{-1}z = \frac{1}{2i} \text{Log} \left(\frac{1+iz}{1-iz} \right)$$

is uniform throughout the z -plane. That branch which has the value zero when $z=0$ is the Principal Value, and is equal to $\frac{1}{2i} \log \left(\frac{1+iz}{1-iz} \right)$; its real part lies between $-\pi/2$ and $\pi/2$, while its imaginary part varies from $-\infty$ to $+\infty$. For any other branch

$$\tan^{-1}z = \frac{1}{2i} \log \left(\frac{1+iz}{1-iz} \right) + m\pi,$$

where m is an integer.

It follows that $\tan(z + m\pi) = \tan z$, and that

$$\frac{d}{dz} \tan^{-1}z = \frac{1}{1+z^2}.$$

19. The Transformation $w = \text{Log } z$. Since $u = \log r$, to circles $|z| = \text{constant}$ in the z -plane correspond lines $u = \text{constant}$ in the

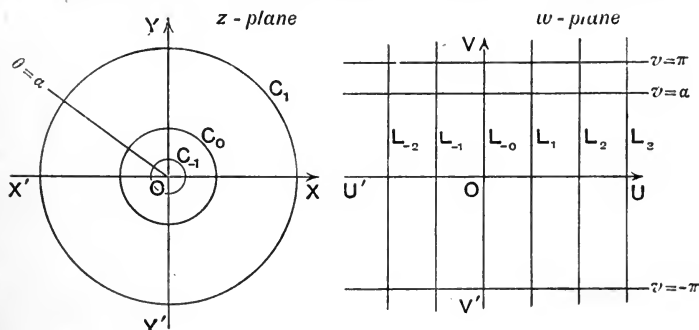

FIG. 22.

w -plane: the circles $C_0, C_1, C_2, \dots, C_{-1}, C_{-2}, \dots$ (Fig. 22) of radii $1, e, e^2, \dots, e^{-1}, e^{-2}, \dots$ correspond to the equi-distant lines

$$L_0, L_1, L_2, \dots, L_{-1}, L_{-2}, \dots,$$

whose equations are $u = 0, 1, 2, \dots, -1, -2, \dots$

To the origin and infinity in the z -plane correspond $u = -\infty$ and $u = +\infty$ in the w -plane.

Again, since $v = \theta$, to the rays $\theta = \text{constant}$ in the z -plane correspond the lines $v = \theta$ in the w -plane; so that, if a cross-cut be taken in the z -plane along the negative x -axis, the entire z -plane is represented by that part of the w -plane which lies between the lines $v = -\pi$ and $v = +\pi$. If now the cross-cut be removed, and θ increase from π to 3π , the entire z -plane corresponds to the strip of the w -plane which lies between the lines $v = \pi$ and $v = 3\pi$. Similarly the entire w -plane can be divided into strips of breadth 2π , on each of which the entire z -plane is represented. Points in these strips which correspond to the same point in the z -plane lie on the same parallel to the v -axis, at distances 2π from each other. To each point in the w -plane, however, corresponds only one point in the z -plane, since $\exp(w)$ is a uniform function of w . Each strip of the w -plane represents one of the branches of w , the boundary in each case being assigned to the strip below it.

Example. Shew that, for all values of m ,

$$\lim_{z \rightarrow 0} z^n (\text{Log } z)^m = 0,$$

provided $\text{R}(n) > 0$.

20. The Generalised Power. Up to this point z^n has only been defined for rational values of n (§§ 5, 6). We are now in a position to define it for all values of n , rational or irrational, real or complex.

If $w = \text{Log } z$, then $z = \exp(w)$; hence

$$z = \exp(\text{Log } z) = \exp(\log z + 2k\pi i),$$

where k is any integer. Accordingly, for all values of n , we define z^n by means of the equation

$$z^n = \exp(n \log z + 2nk\pi i).$$

COROLLARY 1. If n is an integer, z^n has only one value, $\exp(n \log z)$, (cf. § 5).

COROLLARY 2. If n is a fraction p/q (q positive), z^n has q values given by

$$\exp\left(\frac{p}{q} \log z\right) e^{\frac{2k\pi i}{q}}, \quad \text{where } k = 0, 1, 2, \dots, q-1.$$

The reader can easily verify that this agrees with the results of § 6.

COROLLARY 3. If n is irrational or imaginary, z^n has an infinity of values.

Example 1. Prove $\frac{dz^n}{dz} = nz^{n-1}$ for all values of n , where the same value of z^n is taken on both sides of the equation.

Example 2. Shew that, for all finite values of α ,

$$\lim_{z \rightarrow \infty} \left(1 + \frac{\alpha}{z}\right)^z = e^\alpha,$$

where z tends to infinity in any direction whatever.

We have (§ 15, Cor., p. 30) $\lim_{\xi \rightarrow 0} \frac{\log(1 + \alpha\xi)}{\xi} = \alpha$;

so that, if $\xi = 1/z$, $\lim_{z \rightarrow \infty} z \log(1 + \alpha/z) = \alpha$.

Thus, since the exponential function is continuous (§ 12, Th. 4),

$$\lim_{z \rightarrow \infty} \left(1 + \frac{\alpha}{z}\right)^z = \lim_{z \rightarrow \infty} e^{z \log(1 + \alpha/z)} = e^\alpha.$$

See also **Examples III.** 13, 14, 15.

21. Conformal Representation. Let w be a holomorphic function of z ; then, if the points w, w_1, w_2 (Fig. 23), in the w -plane correspond to the points z, z_1, z_2 , in the z -plane,

$$\lim_{z_1 \rightarrow z} \frac{w_1 - w}{z_1 - z} = \frac{dw}{dz} = \lim_{z_2 \rightarrow z} \frac{w_2 - w}{z_2 - z},$$

or

$$\lim \frac{w_2 - w}{w_1 - w} = \lim \frac{z_2 - z}{z_1 - z}.$$

Hence, if the two triangles of vertices w, w_1, w_2 , and z, z_1, z_2 ,

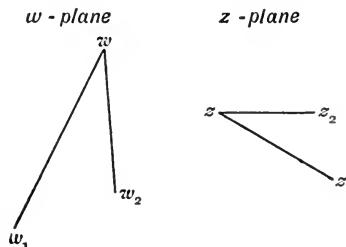

FIG. 23.

are infinitesimally small, they are directly similar. Also, since, to the first order of infinitesimals,

$$(w_1 - w) = \frac{dw}{dz} (z_1 - z),$$

the first triangle can be obtained from the second by turning it through an angle $\text{amp}(dw/dz)$ and magnifying it in the ratio

$|dw/dz|$. It follows that two intersecting curves in the z -plane are represented in the w -plane by curves which intersect at the same angle.

Each plane is said to be represented *Conformally* on the other. Examples of Conformal Representation have been given in §§ 9 and 19. The representation breaks down if $\frac{dw}{dz}$ is either zero or infinite.

Example. Deduce, from the principle of Conformal Representation, the theorem that the curves $u=\text{constant}$, $v=\text{constant}$, intersect at right angles, where u and v are Conjugate Functions.

22. Singular Points. A point at which a function ceases to be holomorphic is called a *Singular* or *Critical Point*, or a *Singularity* of the function. For example, $z=0$ is a singularity of $1/z$.

If a circle can be drawn with the singular point as centre, so as to enclose no other singularity of the function, the singularity is said to be *Isolated*. The function $1/\sin(1/z)$ has a non-isolated singularity at $z=0$: for, since $\sin(1/z)$ is zero for $z=1/(k\pi)$, where k is any integer, it is impossible to surround the origin with a circle which does not contain an infinite number of these points.

A point which can be made the centre of a circle enclosing no singularity is called an *Ordinary Point*. If the radius of the circle is equal to the distance of the point from the nearest singularity, the interior of the circle is called the *Domain* of the point.

Poles. If $\lim_{z \rightarrow z_1} (z - z_1)^n f(z) = C$, where C is a non-zero constant and n a positive integer, z_1 is said to be a *Pole* of $f(z)$ of order n , and $f(z) = \phi(z)/(z - z_1)^n$, where $\phi(z)$ is holomorphic at z_1 . If $n=1$, z_1 is a *Simple Pole* of $f(z)$. For example, $1/z^n$ has a pole of order n at $z=0$.

Example. The function $1/\sin(z - z_1)$ has a simple pole at z_1 : for (§ 15)

$$\lim_{z \rightarrow z_1} \left\{ (z - z_1) \frac{1}{\sin(z - z_1)} \right\} = \left\{ \frac{1}{\cos(z - z_1)} \right\}_{z=z_1} = 1.$$

The function $f(z)$ will have a singularity at infinity if $\xi=0$ is a singularity of $f(1/\xi)$. For example, $az^2 + bz + c$ has a pole of

the second order at infinity. If infinity is an isolated singularity of $f(z)$, $\xi=0$ will be an isolated singularity of $f(1/\xi)$, and a circle $|\xi|=\epsilon$ can be drawn to enclose no singularity of $f(1/\xi)$ except $\xi=0$. Hence a circle $|z|=1/\epsilon$ can be drawn which will have within it every singularity of $f(z)$ except infinity.

Meromorphic Functions. A function which is holomorphic throughout a region except at isolated poles is said to be *Meromorphic* in that region.

Essential Singularities. If no value of n can be found such that $\lim_{z \rightarrow z_1} (z - z_1)^n f(z) = C$, then z_1 is said to be an *Essential Singularity* of $f(z)$. Poles are *Non-Essential Singularities*.

Example. The function $e^{1/z}$ has an essential singularity at $z=0$.

Branch-Points. The branch-points of multiple-valued functions are Singular Points: for example, $z=0$ is a singularity of $\text{Log } z$.

Zeros. If $f(z) = (z - z_1)^n \phi(z)$, where n is a positive integer and $\phi(z)$ is holomorphic and non-zero at z_1 , then z_1 is said to be a *Zero* of $f(z)$ of order n ; a zero of order 1 is also called a *Simple Zero*. If z_1 is a zero of $f(z)$ of order n , it is a pole of $1/f(z)$ of order n .

THEOREM 1. A pole is an isolated singularity.

If z_1 is a pole of $f(z)$ of order n , the function $(z - z_1)^n f(z)$ is holomorphic at z_1 ; consequently, if C is its value at that point, an η can be found such that $|(z - z_1)^n f(z) - C| < \epsilon$, provided $|z - z_1| < \eta$. Hence $f(z)$ must be finite at all points except z_1 in the circle $|z - z_1| = \eta$, so that the singularity is isolated.

COROLLARY 1. The zeros of $f(z)$ must also be isolated, or the function $1/f(z)$ would have non-isolated poles.

COROLLARY 2. If infinity is a pole of $f(z)$, a circle can be drawn which encloses all the singularities of $f(z)$ except infinity.

THEOREM 2. No region can contain an infinite number of isolated singularities.

Let a given region contain only isolated singularities, and let it be divided up as in §13. If there is an infinite number of singularities in the region, one at least of the divisions must contain an infinite number of singularities, and by continuing the process of subdivision a point can be found such that, in every

neighbourhood of it, there is an infinite number of singular points, *i.e.* it is a non-isolated singularity, which is contrary to hypothesis.

COROLLARY. If a function is meromorphic throughout the plane, and has an ordinary point or a pole at infinity, it follows (Th. 1, Cor. 2) that it has only a finite number of singularities.

EXAMPLES III.

1. Shew that $1/\{(z-a)(z-b)(z-c)\}$ is holomorphic except at a , b , and c .
2. Shew that the following functions are holomorphic, and find their derivatives:

(i) $e^{-y}(\cos x + i \sin x)$.	<i>Ans.</i>	$ie^{-y}(\cos x + i \sin x)$.
(ii) $\cosh x \cos y + i \sinh x \sin y$.	<i>Ans.</i>	$\sinh x \cos y + i \cosh x \sin y$.
(iii) $\sin x \cosh y + i \cos x \sinh y$.	<i>Ans.</i>	$\cos x \cosh y - i \sin x \sinh y$.
(iv) $\cos x \cosh y - i \sin x \sinh y$.	<i>Ans.</i>	$-\sin x \cosh y - i \cos x \sinh y$.

3. If n is real, shew that $r^n(\cos n\theta + i \sin n\theta)$ is holomorphic except possibly when $r=0$, and that its derivative is $nr^{n-1}(\cos \overline{n-1}\theta + i \sin \overline{n-1}\theta)$.

4. For what values of z do the functions w defined by the following equations cease to be holomorphic?

(i) $z = e^{-v}(\cos u + i \sin u)$.	<i>Ans.</i>	$z = 0$.
(ii) $z = \sinh u \cos v + i \cosh u \sin v$.	<i>Ans.</i>	$z = \pm i$.
(iii) $z = \sin u \cosh v + i \cos u \sinh v$.	<i>Ans.</i>	$z = \pm 1$.

5. If ϕ and ψ are functions of x and y satisfying Laplace's Equation, shew that $s+it$ is holomorphic, where $s = \frac{\partial\phi}{\partial y} - \frac{\partial\psi}{\partial x}$ and $t = \frac{\partial\phi}{\partial x} + \frac{\partial\psi}{\partial y}$.

6. Shew that $u = e^x(x \cos y - y \sin y)$ is a harmonic function, and find the corresponding holomorphic function. *Ans.* $ze^z + iC$.

7. If $w = z^2$, shew that the curves $u=c_1$, $v=c_2$, are rectangular hyperbolas, and represent them on a diagram for different values of c_1 and c_2 .

8. If $z = \sin u \cosh v + i \cos u \sinh v$, picture on a diagram the orthogonal systems $u=c_1$, $v=c_2$. Shew that the first system consists of confocal hyperbolas, and the second of confocal ellipses.

9. Shew that, (i) $\sin iz = i \sinh z$, (ii) $\cos iz = \cosh z$.

10. Prove

(i)	$\sin(z_1 \pm iz_2) = \sin z_1 \cosh z_2 \pm i \cos z_1 \sinh z_2$,
(ii)	$\cos(z_1 \pm iz_2) = \cos z_1 \cosh z_2 \mp i \sin z_1 \sinh z_2$.

11. Prove

(i)	$ \sin(x \pm iy) = \sqrt{(\sin^2 x + \sinh^2 y)} \begin{cases} \leq \cosh y \\ \equiv \sinh y \end{cases}$,
(ii)	$ \cos(x \pm iy) = \sqrt{(\cos^2 x + \sinh^2 y)} \begin{cases} \leq \cosh y \\ \equiv \sinh y \end{cases}$.

12. Prove $\text{Log}(-1) = (2k+1)\pi i$, where k is any integer.

13. If n is real and $z = re^{i\theta}$, shew that $z^n = r^n e^{ni(\theta+2k\pi)}$, where r^n is real and positive.

14. Shew that $z^n z^{n'} = z^{n+n'}$ for all values of n and n' , where suitable branches of the functions are taken.

15. Shew that $(z^n)^{n'} = z^{nn'}$ for all values of n and n' , where suitable branches of the functions are taken.

16. If $w = \{(z-c)/(z+c)\}^2$, where c is real and positive, find the areas of the z -plane of which the upper half of the w -plane is the conformal representation.

Ans. (i) The lower half of the circle $|z|=c$; (ii) that part of the plane above the x -axis which is exterior to the circle $|z|=c$.

17. If $w = -ic \cot(z/2)$, shew that the infinite rectangle bounded by $x=0$, $x=\pi$, $y=0$, $y=\infty$, on the z -plane is conformally represented on a quarter of the w -plane.

18. Shew that infinity is a simple zero of $(az^2+bz+c)/(lz^3+mz^2+nz+p)$.

19. Shew that the ratio of two polynomials is a meromorphic function.

20. Shew that $\sec z$, $\csc z$, $\tan z$, and $\cot z$ are meromorphic in the finite part of the plane.

21. If $w = \sin^{-1} z$, shew that $w = k\pi \mp i \operatorname{Log} \{iz + \sqrt{(1-z^2)}\}$ according as the integer k is even or odd, a cross-cut being taken along the real axis from 1 to ∞ and from $-\infty$ to -1 to ensure that $\operatorname{Log} \{iz + \sqrt{(1-z^2)}\}$ should be uniform.

Deduce that
$$\frac{d}{dz} \sin^{-1} z = \frac{1}{\sqrt{(1-z^2)}}$$

where the branch of $\frac{1}{\sqrt{(1-z^2)}}$ is chosen which corresponds with the branch of $\sin^{-1} z$ under consideration.

22. Prove (i) $\lim_{z \rightarrow z_1} \frac{z^2 - z_1^2}{z - z_1} = 2z_1$; (ii) $\lim_{z \rightarrow 1} \frac{z^3 - z}{z^2 - 3z + 2} = -2$;

(iii) $\lim_{z \rightarrow n} \frac{z - n}{\sin z\pi} = \frac{(-1)^n}{\pi}$, where n is an integer;

(iv) $\lim_{z \rightarrow 0} \frac{\tan \lambda z}{z} = \lambda$.

23. Shew that all the values of i^i are given by $e^{-(2k+\frac{1}{2})\pi}$, where k is any integer.

24. If $w=1/z$, shew that the curves $u=c_1$, $v=c_2$, are orthogonal circles which pass through the origin, and have their centres on the y -axis and x -axis respectively.

CHAPTER IV.

INTEGRATION.

23. Limit of a Sequence. Let z_1, z_2, z_3, \dots be an infinite sequence of real or complex numbers; the sequence is said to converge to a limit l if, corresponding to any assigned ϵ , a number m can be found such that $|z_n - l| < \epsilon$, when $n \geq m$.

If $z_n = x_n + iy_n$ and $l = a + ib$, then $|x_n - a| < \epsilon$ and $|y_n - b| < \epsilon$; hence it follows that the sequences x_1, x_2, x_3, \dots and y_1, y_2, y_3, \dots converge to the limits a and b . Conversely, if these two sequences tend to the limits a and b , the z -sequence tends to the limit $a + ib$.

THEOREM. The necessary and sufficient condition that the sequence should have a limit is that, corresponding to any ϵ , an n can be found such that $|z_{n+p} - z_n| < \epsilon$, where p is any positive integer.

This condition is necessary, for, if l be the limit,

$$|z_{n+p} - z_n| \leq |z_{n+p} - l| + |z_n - l|.$$

It is also sufficient, for it involves the conditions

$$|x_{n+p} - x_n| < \epsilon, \quad |y_{n+p} - y_n| < \epsilon,$$

which determine the convergence of the x and y sequences.

Uniform Convergence of a Sequence. It may be that all the z 's are functions of a variable ξ : this is indicated by writing $z_n(\xi)$ for z_n . Then if, at all points ξ in a given region, the sequence is convergent and has the limit $l(\xi)$, and if an m can be found such that, for all points within the region, $|z_n(\xi) - l(\xi)| < \epsilon$ when $n \geq m$, the sequence is said to converge *uniformly* within that region.

24. Curvilinear Integrals. Before defining definite integrals of functions of a complex variable, we shall define curvilinear integrals, and prove Green's Theorem.

Consider a curve C (Fig. 24) joining two points A and B in the (x, y) plane. This curve can be divided into segments AL, LM, MN, ..., such that, for each of these segments, only one value of y corresponds to each value of x ; and thus in each segment y is a uniform continuous function of x . Denote these functions by $\phi_1(x), \phi_2(x), \phi_3(x), \dots$.

Now let $f(x, y)$ be a uniform continuous function of x and y in a region of the plane containing the path C. Then the

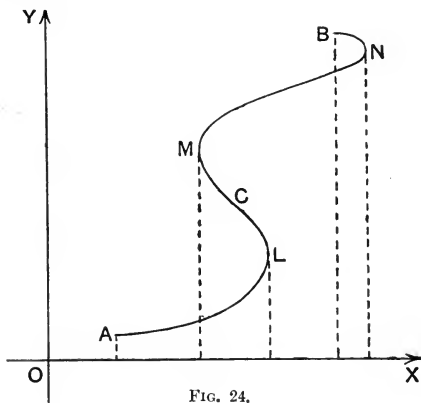

FIG. 24.

functions $f\{x, \phi_1(x)\}, f\{x, \phi_2(x)\}, f\{x, \phi_3(x)\}, \dots$, are uniform continuous functions of x on the arcs AL, LM, MN, ..., respectively, and the integrals

$$\int_a^l f\{x, \phi_1(x)\} dx, \int_l^m f\{x, \phi_2(x)\} dx, \int_m^n f\{x, \phi_3(x)\} dx, \dots,$$

where a, l, m, \dots, b , are the abscissae of A, L, M, ..., B, are ordinary definite integrals. They are the *Curvilinear Integrals*

$$\int_{AL} f(x, y) dx, \int_{LM} f(x, y) dx, \int_{MN} f(x, y) dx, \dots,$$

and their sum is the *Curvilinear Integral*

$$\int_C f(x, y) dx.$$

Similarly, by dividing C into segments in each of which x is a uniform function of y , we can define the curvilinear integral

$\int_C \psi(x, y) dy$. By combining these a third type of curvilinear integral

$$\int_C \{f(x, y) dx + \psi(x, y) dy\}$$

is obtained.

$y = f(x)$

COROLLARY 1. If x and y are uniform functions of a parameter t , the integral becomes

$$\int_{t_0}^{t_1} \left\{ f(x, y) \frac{dx}{dt} + \psi(x, y) \frac{dy}{dt} \right\} dt,$$

where t_0 and t_1 correspond to the initial and final points of C.

COROLLARY 2. If x and y are uniform functions of ξ and η , and if the curve Γ in the (ξ, η) plane corresponds to the curve C in the (x, y) plane,

$$\begin{aligned} \int_C \{f(x, y) dx + \psi(x, y) dy\} \\ = \int_{\Gamma} \left\{ f(x, y) \left(\frac{\partial x}{\partial \xi} d\xi + \frac{\partial x}{\partial \eta} d\eta \right) + \psi(x, y) \left(\frac{\partial y}{\partial \xi} d\xi + \frac{\partial y}{\partial \eta} d\eta \right) \right\}. \end{aligned}$$

COROLLARY 3. If C be divided into n segments by points $(x_1, y_1), (x_2, y_2), \dots, (x_{n+1}, y_{n+1})$, taken in order on the curve, where (x_1, y_1) and (x_{n+1}, y_{n+1}) are the points A and B, and if $(\xi_1, \eta_1), (\xi_2, \eta_2), \dots, (\xi_n, \eta_n)$, are points taken at random on these segments, the sum

$$\sum_{r=1}^n \{f(\xi_r, \eta_r)(x_{r+1} - x_r) + \psi(\xi_r, \eta_r)(y_{r+1} - y_r)\}$$

tends to the limit $\int_C \{f(x, y) dx + \psi(x, y) dy\}$ when the law of division is made to vary in such a way that n tends to infinity and the greatest of the segments tends to zero.

COROLLARY 4.

$$\int_{BA} \{f(x, y) dx + \psi(x, y) dy\} = - \int_{AB} \{f(x, y) dx + \psi(x, y) dy\}.$$

COROLLARY 5. If K is any point on C,

$$\begin{aligned} \int_{AB} \{f(x, y) dx + \psi(x, y) dy\} &= \int_{AK} \{f(x, y) dx + \psi(x, y) dy\} \\ &+ \int_{KB} \{f(x, y) dx + \psi(x, y) dy\}. \end{aligned}$$

COROLLARY 6. If C is a closed curve, the value of the integral is independent of the position of the initial point, but its sign depends on the direction in which the curve is described.

Differentiation under the Integral Sign. If $f(x, y, \alpha)$ and $\frac{\partial}{\partial \alpha} f(x, y, \alpha)$ are continuous functions of x and y on the curve C,

and of the real parameter α between assigned limits for α , and if $\phi(\alpha) = \int_C f(x, y, \alpha) dx$, then $\phi(\alpha)$ has a derivative given by

$$\phi'(\alpha) = \int_C \frac{\partial}{\partial \alpha} f(x, y, \alpha) dx.$$

For

$$\begin{aligned} \Delta\phi(\alpha) &= \phi(\alpha + \Delta\alpha) - \phi(\alpha) \\ &= \int_C \{f(x, y, \alpha + \Delta\alpha) - f(x, y, \alpha)\} dx. \end{aligned}$$

Now, for points on C, $f(x, y, \alpha)$ is a function of two variables x and α ; hence (§ 13)

$$f(x, y, \alpha + \Delta\alpha) = f(x, y, \alpha) + \left\{ \frac{\partial}{\partial \alpha} f(x, y, \alpha) + \lambda \right\} \Delta\alpha,$$

where λ tends uniformly to zero with $\Delta\alpha$.

$$\text{Therefore } \left| \frac{\Delta\phi(\alpha)}{\Delta\alpha} - \int_C \frac{\partial}{\partial \alpha} f(x, y, \alpha) dx \right| = \left| \int_C \lambda dx \right|,$$

and the latter expression tends to zero with $\Delta\alpha$.

Thus $\phi(\alpha)$ has a derivative, given by

$$\phi'(\alpha) = \lim_{\Delta\alpha \rightarrow 0} \frac{\Delta\phi(\alpha)}{\Delta\alpha} = \int_C \frac{\partial}{\partial \alpha} f(x, y, \alpha) dx.$$

25. Green's Theorem. This theorem gives an important relation between a double integral and a curvilinear integral.

Let the functions $P(x, y)$ and $Q(x, y)$ be uniform and continuous, and possess continuous partial derivatives, in a simply-

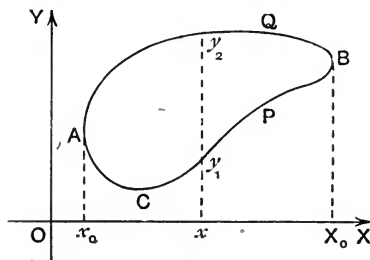

FIG. 25.

connected region containing a closed curve C. Consider the double integral

$$\iint \left(-\frac{\partial P}{\partial y} + \frac{\partial Q}{\partial x} \right) dx dy$$

taken over the simply-connected area enclosed by C.

Assume in the first place that C (Fig. 25) is a curve such that

no line parallel to either of the axes cuts it in more than two points.

Let y_1 and y_2 ($y_2 \geq y_1$) be the values of y on C corresponding to any value of x , and let A and B be the points on C of minimum and maximum abscissae x_0 and X_0 .

$$\text{Then} \quad -\iint \frac{\partial P}{\partial y} dx dy = -\int_{x_0}^{X_0} \{P(x, y_2) - P(x, y_1)\} dx.$$

The latter expression is the sum of the two curvilinear integrals

$$-\int_{AQB} P(x, y) dx, \quad \int_{APB} P(x, y) dx;$$

and therefore, since $-\int_{AQB} P(x, y) dx = \int_{BQA} P(x, y) dx$,

$$-\iint \frac{\partial P}{\partial y} dx dy = \int_C P(x, y) dx,$$

the integral being taken round C in the positive direction.

$$\text{Similarly} \quad \iint \frac{\partial Q}{\partial x} dx dy = \int_C Q(x, y) dy.$$

Hence Green's Theorem,

$$\iint \left(-\frac{\partial P}{\partial y} + \frac{\partial Q}{\partial x} \right) dx dy = \int_C (P dx + Q dy),$$

holds for the region considered.

Next, if C does not satisfy the condition that no line parallel to either of the axes cuts it in more than two points, the region can be divided into regions each of which possesses this property. For example, if in Fig. 26 the points A and B , at which the

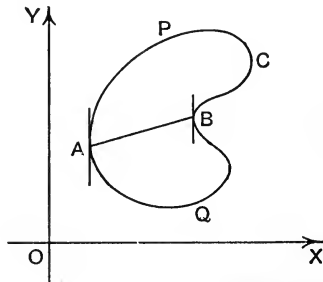

FIG. 26.

tangents are parallel to the y -axis, are joined by a straight line, the two regions so obtained are of the type required.

Hence

$$\begin{aligned} \iint \left(-\frac{\partial P}{\partial y} + \frac{\partial Q}{\partial x} \right) dx dy &= \int_{AQB A} (P dx + Q dy) + \int_{ABPA} (P dx + Q dy) \\ &= \int_C (P dx + Q dy), \end{aligned}$$

since the sum of the integrals along AB and BA is zero.

Thus the theorem can be shewn to hold for all simply-connected regions bounded by closed curves.

COROLLARY. The area of the region enclosed by C is given by any of the three integrals

$$-\int_C y dx, \quad \int_C x dy, \quad \frac{1}{2} \int_C (x dy - y dx).$$

Multiply-Connected Regions. Consider the region between the curves C and C' (Fig. 27). This region can be made simply-

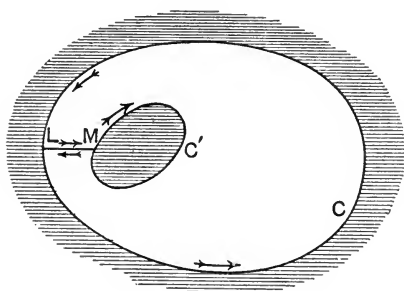

FIG. 27.

connected by drawing a line LM from C to C'. Hence

$$\begin{aligned} \iint \left(-\frac{\partial P}{\partial y} + \frac{\partial Q}{\partial x} \right) dx dy &= \int_C (P dx + Q dy) + \int_{LM} (P dx + Q dy) \\ &\quad - \int_{C'} (P dx + Q dy) + \int_{ML} (P dx + Q dy) \\ &= \int_C (P dx + Q dy) - \int_{C'} (P dx + Q dy), \end{aligned}$$

where the latter integral is taken positively round C'.

Similarly, for the region between the curve C (Fig. 28) and the n curves $c_1, c_2, c_3, \dots, c_n$, it can be shewn that

$$\iint \left(-\frac{\partial P}{\partial y} + \frac{\partial Q}{\partial x} \right) dx dy = \int_C (P dx + Q dy) - \sum_{r=1}^n \int_{c_r} (P dx + Q dy).$$

Example. If $P dx + Q dy$ is a complete differential, shew that

$$\int_C (P dx + Q dy) = 0,$$

where C is a closed curve.

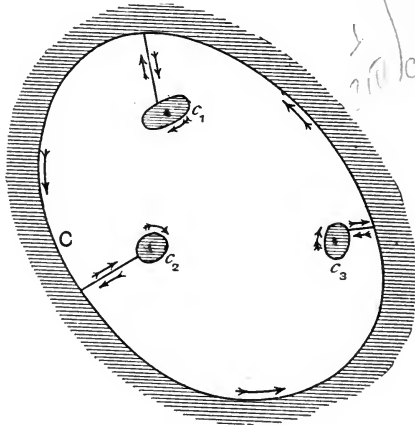

FIG. 28.

26. Definite Integrals. Let $f(z) = u(x, y) + iv(x, y)$ be a uniform continuous function of z in a given region, and let ACB (Fig. 29) be a curve in this region connecting the points z_0 and z_n .

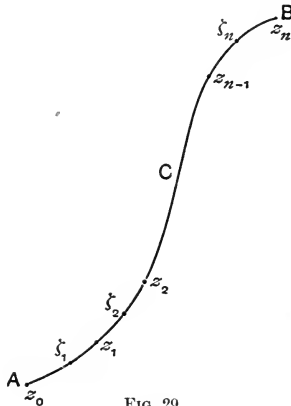

FIG. 29.

Let z_1, z_2, \dots, z_n , be n points taken in order on this line, where z_n is z , and let $\xi_1, \xi_2, \dots, \xi_n$ be arbitrary points on the segments $(z_0, z_1), (z_1, z_2), \dots, (z_{n-1}, z_n)$. Then if, in the sum

$$S_n = \sum_{r=1}^n f(\xi_r)(z_r - z_{r-1}),$$

the real and imaginary parts be separated, we obtain

$$S_n = \sum_{r=1}^n \{u(\xi_r, \eta_r)(x_r - x_{r-1}) - v(\xi_r, \eta_r)(y_r - y_{r-1})\} \\ + i \sum_{r=1}^n \{v(\xi_r, \eta_r)(x_r - x_{r-1}) + u(\xi_r, \eta_r)(y_r - y_{r-1})\},$$

where $\xi_r = \xi_r + i\eta_r$.

Now if the law of division of the curve ACB varies so that n tends to infinity and the greatest of the segments tends to zero, this latter expression tends to the limit (§ 24),

$$\int_{ACB} (u dx - v dy) + i \int_{ACB} (v dx + u dy),$$

or
$$\int_{ACB} (u + iv)(dx + i dy).$$

This limiting value of S_n is called the integral of the function $f(z)$ taken along the curve ACB, and is written

$$\int_{ACB} f(z) dz.$$

COROLLARY 1. From the theory of limits it follows that, corresponding to any ϵ , an n can be found such that

$$\left| S_n - \int_{ACB} f(z) dz \right| < \epsilon.$$

COROLLARY 2.
$$\int_{BCA} f(z) dz = - \int_{ACB} f(z) dz.$$

COROLLARY 3.
$$\int_{AC} f(z) dz + \int_{CB} f(z) dz = \int_{ACB} f(z) dz.$$

COROLLARY 4.
$$\int_{ACB} \{f_1(z) + f_2(z) + \dots + f_n(z)\} dz \\ = \int_{ACB} f_1(z) dz + \int_{ACB} f_2(z) dz + \dots + \int_{ACB} f_n(z) dz.$$

COROLLARY 5.
$$\int_{ACB} kf(z) dz = k \int_{ACB} f(z) dz,$$
 where k is a constant.

COROLLARY 6.
$$\int_{ACB} f(z) dz = \int_{\alpha\gamma\beta} f\{\phi(\xi)\} \phi'(\xi) d\xi,$$
 where $\phi(\xi)$ is a

holomorphic function of ξ , and the path ACB in the z -plane corresponds to the path $\alpha\gamma\beta$ in the ξ -plane.

$$\begin{aligned}
 \text{For } \int_{ACB} f(z) dz &= \int (u dx - v dy) + i \int (v dx + u dy) \\
 &= \left\{ u \left(\frac{\partial x}{\partial \xi} d\xi + \frac{\partial x}{\partial \eta} d\eta \right) - v \left(\frac{\partial y}{\partial \xi} d\xi + \frac{\partial y}{\partial \eta} d\eta \right) \right\} \\
 &+ i \left\{ v \left(\frac{\partial x}{\partial \xi} d\xi + \frac{\partial x}{\partial \eta} d\eta \right) + u \left(\frac{\partial y}{\partial \xi} d\xi + \frac{\partial y}{\partial \eta} d\eta \right) \right\} \\
 &= \left\{ u \left(\frac{\partial x}{\partial \xi} d\xi - \frac{\partial y}{\partial \xi} d\eta \right) - v \left(\frac{\partial y}{\partial \xi} d\xi + \frac{\partial x}{\partial \xi} d\eta \right) \right\} \\
 &+ i \left\{ v \left(\frac{\partial x}{\partial \xi} d\xi - \frac{\partial y}{\partial \xi} d\eta \right) + u \left(\frac{\partial y}{\partial \xi} d\xi + \frac{\partial x}{\partial \xi} d\eta \right) \right\},
 \end{aligned}$$

since z is a holomorphic function of ζ ,

$$\begin{aligned}
 &= \int (u + iv) \left(\frac{\partial x}{\partial \xi} + i \frac{\partial y}{\partial \xi} \right) (d\xi + i d\eta) \\
 &= \int_{\alpha\gamma\beta} f(\phi(\zeta)) \phi'(\zeta) d\zeta.
 \end{aligned}$$

COROLLARY 7. The modulus of the integral is finite.

For, let M be the greatest value of $|f(z)|$ on ACB ; then, since

$$|S_n| \leq \sum_{r=1}^n |f(\zeta_r)| |z_r - z_{r-1}| \leq M \sum_{r=1}^n |z_r - z_{r-1}|,$$

$$\left| \int_{ACB} f(z) dz \right| \leq Ml,$$

where l is the length of ACB .

COROLLARY 8. If $F(z)$ is a holomorphic function whose derivative is $f(z)$, $\int_{z_0}^z f(z) dz = F(z) - F(z_0)$.

For, let $F(z) = U(x, y) + iV(x, y)$; then

$$u = \frac{\partial U}{\partial x} = \frac{\partial V}{\partial y}, \quad v = \frac{\partial V}{\partial x} = -\frac{\partial U}{\partial y}.$$

Therefore

$$\begin{aligned}
 \int_{z_0}^z f(z) dz &= \int (u dx - v dy) + i \int (v dx + u dy) \\
 &= \int \left(\frac{\partial U}{\partial x} dx + \frac{\partial U}{\partial y} dy \right) + i \int \left(\frac{\partial V}{\partial x} dx + \frac{\partial V}{\partial y} dy \right).
 \end{aligned}$$

Now the integrands are complete differentials; therefore the integrals are the limits of the sum of the increments of $U(x, y)$

and $V(x, y)$ obtained in going along ACB from (x_0, y_0) to (x, y) . Hence

$$\int_{z_0}^z f(z) dz = \{U(x, y) - U(x_0, y_0)\} + i\{V(x, y) - V(x_0, y_0)\} \\ = F(z) - F(z_0).$$

Since $F(z)$ is single-valued, it follows that the value of the integral is independent of the path.

Example. Shew that $\int_{z_0}^z z^n dz = (z^{n+1} - z_0^{n+1})/(n+1)$ for all integral values of n except -1 . If n is negative, the path must not pass through the origin. See also **Examples IV.** 1-4.

Consider now the integral $\int_C f(z) dz$, where the path C goes to infinity.

By means of the transformation $z - c = 1/\xi$, where c does not lie on C , C is transformed into a finite path C' with $\xi = 0$ as final point, and the integral becomes

$$-\int_{C'} f\left(c + \frac{1}{\xi}\right) \frac{d\xi}{\xi^2}.$$

In order that the integrand $f(c + 1/\xi)/\xi^2$ should be continuous, $\lim_{\xi \rightarrow 0} f(c + 1/\xi)/\xi^2$ or $\lim_{z \rightarrow \infty} z^2 f(z)$ must be finite. Hence the given integral has a definite value if $\lim_{z \rightarrow \infty} z^2 f(z)$ is finite.

Example. $\int_1^\infty \frac{dz}{z^2} = -\int_1^0 d\xi = 1$, provided that the path in the z -plane does not go through the origin.

27. Cauchy's Integral Theorem. If a function $f(z)$ is holomorphic in a simply-connected region A , and if C is a closed contour lying entirely within A , $\int_C f(z) dz = 0$.

Let $f(z) = u + iv$; then, by Green's Theorem,

$$\int_C f(z) dz = \int_C (u dx - v dy) + i \int_C (v dx + u dy) \\ = \iint \left(-\frac{\partial u}{\partial y} - \frac{\partial v}{\partial x}\right) dx dy + i \iint \left(-\frac{\partial v}{\partial y} + \frac{\partial u}{\partial x}\right) dx dy,$$

the double integrals being taken over the area enclosed by C .

Hence (equations (A), § 15)

$$\int_C f(z) dz = 0.$$

Example. From the integral $\int_C \frac{dz}{z+2}$, where C denotes the circle $|z|=1$, deduce

$$\int_0^\pi \frac{1+2 \cos \theta}{5+4 \cos \theta} d\theta=0.$$

The following important theorems are corollaries of Cauchy's Theorem :

THEOREM 1. Let $f(z)$ be holomorphic within a simply-connected region, and let the paths ABC (Fig. 30) and ADC

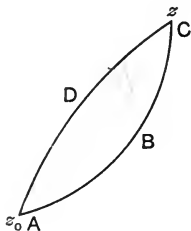

FIG. 30.

joining the points z_0 and z lie entirely within the region. Then

$$\int_{ABC} f(z) dz + \int_{CDA} f(z) dz = 0;$$

so that

$$\int_{ABC} f(z) dz = \int_{ADC} f(z) dz.$$

The integral is therefore independent of the path, so long as the path lies entirely within the region.

THEOREM 2. Under the conditions of Theorem 1, $F(z) = \int_{z_0}^z f(z) dz$ is a holomorphic function of z .

Let the increment $\Delta F(z)$ of $F(z)$ correspond to the increment Δz of z ; then

$$\begin{aligned} \Delta F(z) &= \int_{z_0}^{z+\Delta z} f(z) dz - \int_{z_0}^z f(z) dz = \int_z^{z+\Delta z} f(\xi) d\xi \\ &= \int_z^{z+\Delta z} f(z) d\xi + \int_z^{z+\Delta z} \{f(\xi) - f(z)\} d\xi \\ &= f(z) \Delta z + \int_z^{z+\Delta z} \{f(\xi) - f(z)\} d\xi. \end{aligned}$$

Now take $|\Delta z|$ so small that $|f(\xi) - f(z)| < \epsilon$ for all points ξ on the line joining z and $z + \Delta z$; then

$$|\Delta F(z) - f(z) \Delta z| < \epsilon |\Delta z|.$$

Therefore

$$\left| \frac{\Delta F(z)}{\Delta z} - f(z) \right| < \epsilon.$$

Hence $F(z)$ has a definite derivative $f(z)$; it is therefore holomorphic throughout the region.

From this theorem the method of *Partial Integration* can be derived exactly as for the real variable.

As in the theory of integrals of real functions, we say that a function $F(z)$, which is such that $\frac{dF(z)}{dz} = f(z)$, is an *Indefinite Integral* of $f(z)$; and we write

$$F(z) = \int f(z) dz.$$

Example. Prove $\int \log z dz = z \log z - z.$

THEOREM 3. Let $f(z)$ be holomorphic in* the ring-space bounded by the curves C and C' (Fig. 27); then

$$\int_C f(z) dz = \int_{C'} f(z) dz,$$

the integration in both cases being in the positive (or negative) direction.

For, by Cauchy's Theorem,

$$\int_C f(z) dz + \int_{LM} f(z) dz - \int_{C'} f(z) dz + \int_{ML} f(z) dz = 0.$$

But
$$\int_{ML} f(z) dz = - \int_{LM} f(z) dz.$$

Therefore
$$\int_C f(z) dz = \int_{C'} f(z) dz.$$

Similarly, if $f(z)$ is holomorphic in* the region between C (Fig. 28) and the n curves c_1, c_2, \dots, c_n , it can be shewn that

$$\int_C f(z) dz = \sum_{r=1}^n \int_{c_r} f(z) dz.$$

THEOREM 4. If a is a point enclosed by a curve C ,

$$\int_C \frac{dz}{z-a} = 2\pi i.$$

Round a describe a small circle c of radius r ; then (Theorem 3)

$$\int_C \frac{dz}{z-a} = \int_c \frac{dz}{z-a}.$$

* Here, as in Cauchy's Theorem, it is to be understood that the boundaries lie inside a region in which $f(z)$ is holomorphic.

On c let $z - a = re^{i\theta}$; then $dz = re^{i\theta} i d\theta$. Therefore

$$\int_0^{2\pi} \frac{dz}{z-a} = \int_0^{2\pi} i d\theta = 2\pi i.$$

28. Cauchy's Theorem: Alternative Proof.* The following proof of Cauchy's Theorem does not depend on Green's Theorem.

The proof will be taken in three parts: firstly, for C a triangle; secondly, for C an arbitrary polygon; and, lastly, for C any closed curve.

(1) Let C be a triangle Δ (ABC in Fig. 31), and let the midpoints D , E , and F of the sides be joined, so that the triangle is divided into four congruent triangles Δ' , Δ'' , Δ''' , Δ^{iv} .

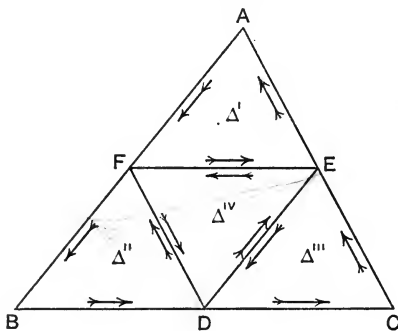

FIG. 31.

Now integrate round these four triangles in succession in the same (positive) direction, as indicated by the arrows. The two integrals along each of the lines DE , EF , and FD cancel each other, so that the net result is the integral round Δ in the positive direction. Hence

$$\int_{\Delta} f(z) dz = \int_{\Delta'} f(z) dz + \int_{\Delta''} f(z) dz + \int_{\Delta'''} f(z) dz + \int_{\Delta^{iv}} f(z) dz;$$

so that

$$\left| \int_{\Delta} f(z) dz \right| \leq \sum \left| \int_{\Delta'} f(z) dz \right|.$$

There must therefore be at least one of these smaller triangles—we denote it by Δ_1 —such that

$$\left| \int_{\Delta} f(z) dz \right| \leq 4 \left| \int_{\Delta_1} f(z) dz \right|.$$

* Cf. Knopp, *Funktionentheorie*, Vol. I.

Dealing with Δ_1 in the same way, we obtain a triangle Δ_2 such that

$$\left| \int_{\Delta_1} f(z) dz \right| \leq 4 \left| \int_{\Delta_2} f(z) dz \right|;$$

and therefore

$$\left| \int_{\Delta} f(z) dz \right| \leq 4^2 \left| \int_{\Delta_2} f(z) dz \right|.$$

Proceeding thus, we obtain a sequence of similar triangles $\Delta, \Delta_1, \Delta_2, \dots$, each contained by the preceding one, and such that

$$\Delta_{n+1} = \frac{1}{4} \Delta_n, \text{ and } \left| \int_{\Delta} f(z) dz \right| \leq 4^n \left| \int_{\Delta_n} f(z) dz \right|, \quad n = 1, 2, 3, \dots$$

As n tends to infinity, the triangle Δ_n shrinks to a point, ξ say, which lies within every one of the triangles $\Delta, \Delta_1, \Delta_2, \dots$. Now, corresponding to any ϵ , an η can be found such that $|\lambda| < \epsilon$ if $|z - \xi| < \eta$, where

$$f(z) = f(\xi) + (z - \xi)f'(\xi) + (z - \xi)\lambda.$$

Let n be chosen so great that Δ_n lies entirely within the circle $|z - \xi| = \eta$; then

$$\begin{aligned} \int_{\Delta_n} f(z) dz &= \int_{\Delta_n} f(\xi) dz + \int_{\Delta_n} f'(\xi)(z - \xi) dz + \int_{\Delta_n} \lambda(z - \xi) dz \\ &= f(\xi) \int_{\Delta_n} dz + f'(\xi) \int_{\Delta_n} (z - \xi) dz + \int_{\Delta_n} \lambda(z - \xi) dz. \end{aligned}$$

The first two of these integrals vanish (§ 26, Corollary 8), so that

$$\int_{\Delta_n} f(z) dz = \int_{\Delta_n} \lambda(z - \xi) dz.$$

Therefore

$$\left| \int_{\Delta_n} f(z) dz \right| \leq \int_{\Delta_n} |\lambda| |z - \xi| |dz|$$

$$\leq \epsilon \frac{s_n}{2} s_n, \text{ where } s_n \text{ is the perimeter of } \Delta_n,$$

$$\leq \frac{\epsilon}{2} \left(\frac{s}{2^n} \right)^2, \text{ where } s \text{ is the perimeter of } \Delta.$$

Hence

$$\left| \int_{\Delta} f(z) dz \right| \leq 4^n \frac{\epsilon}{2} \left(\frac{s}{2^n} \right)^2 = \frac{\epsilon}{2} s^2.$$

Therefore

$$\int_{\Delta} f(z) dz = 0.$$

(2) If C (Fig. 32) is a quadrilateral, it can be divided into two triangles Δ and Δ' by a diagonal which lies within it; then

$$\int_C f(z) dz = \int_{\Delta} f(z) dz + \int_{\Delta'} f(z) dz = 0.$$

Similarly, if C is any polygon, it can be divided into triangles

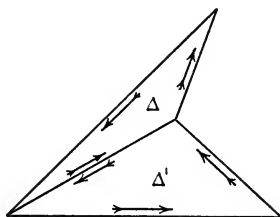

FIG. 32.

by diagonals lying within it, and, since the integrals along these diagonals cancel each other, $\int_C f(z) dz = 0$.

(3) Let C be any closed curve; then, as in § 26,

$$\int_C f(z) dz = \text{Lim } S_n, \text{ where } S_n = \sum_{r=1}^n f(z_r)(z_r - z_{r-1}).$$

Now let $f(z) = f(z_r) + \eta_r$ for points z on the straight line joining z_{r-1} and z_r , and let the law of division of C vary so that, for $r=1, 2, 3, \dots, n$, $|\eta_r| < \epsilon/(2L)$, where L is the length of C , and also

$$\left| \int_C f(z) dz - S_n \right| < \frac{\epsilon}{2}.$$

Then, if P is the polygon of vertices $z_0, z_1, z_2, \dots, z_n$,

$$\int_P f(z) dz = \sum_{r=1}^n \int_{z_{r-1}}^{z_r} \{f(z_r) + \eta_r\} dz = S_n + \sum_{r=1}^n \int_{z_{r-1}}^{z_r} \eta_r dz.$$

But $\int_P f(z) dz = 0$; therefore

$$|S_n| < \sum_{r=1}^n \frac{\epsilon}{2L} |z_r - z_{r-1}| \leq \frac{\epsilon}{2}.$$

Therefore $\left| \int_C f(z) dz \right| \leq \left| \int_C f(z) dz - S_n \right| + |S_n| < \epsilon$.

Hence $\int_C f(z) dz = 0$.

29. Cauchy's Residue Theorem. If the point a is the only singularity of $f(z)$ contained in a closed contour C , and if

$$\frac{1}{2\pi i} \int_C f(z) dz$$

has a value, that value is called the *Residue* of $f(z)$ at a .

From Theorem 3, §27, it follows that, if C encloses several singularities, the sum of the residues at these points is

$$\frac{1}{2\pi i} \int_C f(z) dz.$$

The following cases are important:

CASE 1. If n is any integer except 1, the residue of $(z-a)^{-n}$ at a is zero.

CASE 2. The residue of $(z-a)^{-1}$ at a is unity. *Rem 4/53*

CASE 3. If

$$f(z) = A_1/(z-a) + A_2/(z-a)^2 + \dots + A_n/(z-a)^n + \phi(z),$$

where $\phi(z)$ is holomorphic at a , the residue of $f(z)$ at a is A_1 .

Example. Shew that the residue of $(2z+3)/(z-1)^2$ at 1 is 2.

CASE 4. If $f(z)$ is holomorphic at a , the residue of $f(z)/(z-a)$ at a is $f(a)$: for

$$\begin{aligned} \frac{1}{2\pi i} \int_C \frac{f(z)}{z-a} dz &= \frac{1}{2\pi i} \int_C \frac{f(a)}{z-a} dz + \frac{1}{2\pi i} \int_C \frac{f(z)-f(a)}{z-a} dz \\ &= f(a) + \frac{1}{2\pi i} \int_C f'(a) dz + \frac{1}{2\pi i} \int_C \lambda dz \\ &= f(a) + \frac{1}{2\pi i} \int_C \lambda dz. \end{aligned}$$

Now take C so small that for all points on it $|\lambda| < \epsilon$; then

$$\left| \frac{1}{2\pi i} \int_C \frac{f(z)}{z-a} dz - f(a) \right| < \frac{\epsilon}{2\pi} l,$$

where l is the length of C .

Hence
$$\frac{1}{2\pi i} \int_C \frac{f(z)}{z-a} dz = f(a).$$

This is equivalent to the following theorem:

THEOREM 1. If $\lim_{z \rightarrow a} \{(z-a)f(z)\}$ is a definite number A , the residue of $f(z)$ at a is A .

It follows that, if $\phi(z)$ and $\psi(z)$ are polynomials in z , and if $z-a$ is a non-repeated factor of $\psi(z)$, the residue of $\phi(z)/\psi(z)$ at a is $\phi(a)/\psi'(a)$.

Example. Shew that the residues of $(pz^2+qz+r)/\{(z-a)(z-b)\}$ at a and b are $(pa^2+qa+r)/(a-b)$ and $(pb^2+qb+r)/(b-a)$.

See also **Examples IV.** 5-7.

Multiply-Connected Regions. If $f(z)$ satisfies the conditions of Theorem 3, § 27, except for isolated singularities at points in the space between C and the curves c_1, c_2, \dots, c_n , the sum of the residues at these points is

$$\frac{1}{2\pi i} \int_C f(z) dz - \sum_{r=1}^n \frac{1}{2\pi i} \int_{c_r} f(z) dz.$$

Residue at Infinity. If $f(z)$ has an isolated singularity at infinity, and if C is a large circle which encloses all the singularities of $f(z)$ except infinity, the residue of $f(z)$ at infinity is defined to be

$$\frac{1}{2\pi i} \int_C f(z) dz,$$

taken round C in the negative direction (negative with respect to the origin), provided that this integral has a definite value.

If the transformation $z=1/\xi$ be applied to the integral, it becomes

$$\frac{1}{2\pi i} \int -f\left(\frac{1}{\xi}\right) \frac{d\xi}{\xi^2},$$

taken positively round a small circle about the origin. Hence it follows that, if $\text{Lim}_{\xi \rightarrow 0} \{-f(1/\xi)/\xi\}$ or $\text{Lim}_{z \rightarrow \infty} \{-zf(z)\}$ has a definite value, that value is the residue of $f(z)$ at infinity.

Example. Shew that the residues of $z/\{(z-a)(z-b)\}$ and $(z^3-z^2+1)/z^3$ at infinity are -1 and 1 .

Note. Both of these examples shew that, if a function is holomorphic at infinity, it does not necessarily follow that its residue there is zero.

THEOREM 2. If a uniform function has only a finite number of singularities, the sum of the residues at these singularities, that at infinity being included, is zero.

Let C be a closed contour enclosing all the singularities of $f(z)$ except infinity: then the sum of the residues at these singularities is

$$\frac{1}{2\pi i} \int_C f(z) dz.$$

But the residue at infinity is

$$-\frac{1}{2\pi i} \int_C f(z) dz.$$

Hence the sum of the residues is zero.

Example. Evaluate the residues of $z^3/\{(z-1)(z-2)(z-3)\}$ at 1, 2, 3, and infinity, and shew that their sum is zero. *Ans.* $1/2, -8, 27/2, -6.$

See also **Examples IV.** 8-10.

30. Evaluation of Definite Integrals. Many definite integrals can be evaluated by means of integrals round closed contours.

Example 1. Prove $\int_0^\infty \frac{\cos x dx}{x^2+a^2} = \frac{\pi e^{-a}}{2a}$, where $a > 0$.

Integrate $f(z) = e^{iz}/(z^2+a^2)$ round the contour (Fig. 33) consisting of :

- (1) the x -axis from $-R$ to R , where R is large ;
- (2) that half of the circle $|z|=R$ which lies above the x -axis.

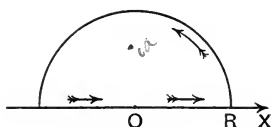

FIG. 33.

The only pole of $f(z)$ within the contour is ia , at which the residue is

$$\lim_{z \rightarrow ia} \left\{ (z-ia) \frac{e^{iz}}{z^2+a^2} \right\} = \frac{e^{-a}}{2ia}.$$

Hence $\int_{-R}^R f(x) dx + \int_0^\pi f(Re^{i\theta}) Re^{i\theta} i d\theta = 2\pi i \frac{e^{-a}}{2ia} = \frac{\pi}{a} e^{-a}.$

But $\left| \int_0^\pi f(Re^{i\theta}) Re^{i\theta} i d\theta \right| \leq \int_0^\pi \frac{e^{-R \sin \theta}}{R^2 - a^2} R d\theta$
 $< \frac{R}{R^2 - a^2} \int_0^\pi d\theta$, since $e^{-R \sin \theta} \leq 1$
 $< \frac{\pi R}{R^2 - a^2}.$

Hence the integral along the semi-circle tends to zero as R tends to infinity.

Therefore $\int_{-\infty}^{+\infty} \frac{e^{ix}}{x^2+a^2} dx = \frac{\pi e^{-a}}{a};$

so that $\int_0^\infty \frac{\cos x}{x^2+a^2} dx = \frac{\pi e^{-a}}{2a}.$

Method is not sufficient
for Res. n
sin θ → e^{-R sin θ}

THEOREM 1. Let AB (Fig. 34) be that arc of the circle $|z| = R$ for which $\theta_1 \leq \theta \leq \theta_2$, where $\theta = \text{amp } z$; and let $zf(z)$, as R tends

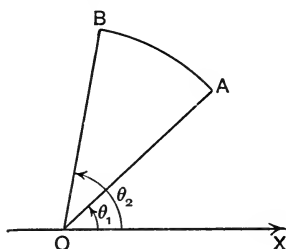

FIG. 34.

to infinity, tend uniformly to the limit K , where K is a constant; then

$$\lim_{R \rightarrow \infty} \int_{AB} f(z) dz = i(\theta_2 - \theta_1)K.$$

For, let $zf(z) = K + \lambda$, and choose R so great that $|\lambda| < \epsilon$; then

$$\begin{aligned} \left| \int_{AB} \frac{K + \lambda}{z} dz - i(\theta_2 - \theta_1)K \right| &= \left| \int_{\theta_1}^{\theta_2} (K + \lambda)i d\theta - i(\theta_2 - \theta_1)K \right| \\ &= \left| \int_{\theta_1}^{\theta_2} \lambda d\theta \right| \\ &< \epsilon(\theta_2 - \theta_1). \end{aligned}$$

Hence
$$\lim_{R \rightarrow \infty} \int_{AB} f(z) dz = i(\theta_2 - \theta_1)K.$$

For example, in *Example 1*, $|zf(z)| \leq R/(R^2 - a^2)$, so that $K = 0$.

Example 2. If $m > 0$, prove

$$\int_0^{\infty} \frac{\cos mx dx}{1 + x^2 + x^4} = \frac{\pi}{\sqrt{3}} e^{-\frac{\sqrt{3}}{2}m} \sin\left(\frac{m}{2} + \frac{\pi}{6}\right).$$

[Integrate $e^{imz}/(1 + z^2 + z^4)$ round the contour of Fig. 33.]

From Theorem 1 it follows that, if $f(z) = \phi(z)/\psi(z)$, where $\psi(z)$ is a polynomial of degree n , and $\phi(z)$ is a polynomial of degree less than n ,

$$\lim_{R \rightarrow \infty} \int_{AB} f(z) dz = i(\theta_2 - \theta_1) \frac{a}{b},$$

where a and b are the coefficients of z^{n-1} and z^n in $\phi(z)$ and $\psi(z)$ respectively.

In particular, if the degree of $\phi(z)$ is $\leq n - 2$, a is zero, and therefore the integral of $f(z)$ round the contour of Fig. 33 gives

$$\int_{-\infty}^{+\infty} f(x) dx = 2\pi i \Sigma,$$

where Σ denotes the sum of the residues of $f(z)$ at points above the x -axis.

Example 3. Prove $\int_0^\infty \frac{dx}{x^4+a^4} = \frac{\pi\sqrt{2}}{4a^3}$, where $a > 0$.

The residue of $1/(z^4+a^4)$ at a pole α is

$$\left[1/\left\{ \frac{d}{dz}(z^4+a^4) \right\} \right]_{z=\alpha} = 1/4\alpha^3.$$

But the poles above the x -axis are $ae^{i\pi/4}$ and $ae^{i3\pi/4}$.

Therefore $\int_{-\infty}^{+\infty} \frac{dx}{x^4+a^4} = 2\pi i \left\{ \frac{1}{4a^3} e^{-i3\pi/4} + \frac{1}{4a^3} e^{-i\pi/4} \right\} = \frac{\pi\sqrt{2}}{2a^3}$.

Hence $\int_0^\infty \frac{dx}{x^4+a^4} = \frac{\pi\sqrt{2}}{4a^3}$.

The inequality $\sin \theta \geq 2\theta/\pi$, where $0 \leq \theta \leq \pi/2$, is frequently found useful.

Example 4. Prove $\int_0^\infty \frac{x \sin x}{x^2+a^2} dx = \frac{\pi}{2} e^{-a}$, where $a > 0$.

Integrate $f(z) = ze^{iz}/(z^2+a^2)$ round the contour of Fig. 33. The only pole within the contour is ia , the residue at which is $e^{-a}/2$. Hence

$$\int_{-R}^R f(x) dx + \int_0^\pi f(Re^{i\theta}) Re^{i\theta} i d\theta = \pi i e^{-a}.$$

But

$$\begin{aligned} \left| \int_0^\pi f(Re^{i\theta}) Re^{i\theta} i d\theta \right| &< \int_0^\pi \frac{R^2 e^{-R \sin \theta}}{R^2 - a^2} d\theta \\ &< \frac{2R^2}{R^2 - a^2} \int_0^{\frac{\pi}{2}} e^{-R \sin \theta} d\theta \\ &< \frac{2R^2}{R^2 - a^2} \int_0^{\frac{\pi}{2}} e^{-\frac{2R\theta}{\pi}} d\theta \\ &< \frac{\pi R}{R^2 - a^2} (1 - e^{-R}). \end{aligned}$$

Hence $\lim_{R \rightarrow \infty} \int_0^\pi f(Re^{i\theta}) Re^{i\theta} i d\theta = 0$.

Therefore $\int_{-\infty}^{+\infty} f(x) dx = \pi i e^{-a}$;

so that $\int_0^\infty \frac{x \sin x}{x^2+a^2} dx = \frac{\pi}{2} e^{-a}$.

Example 5. Integrate e^{-z^2} over the following contour (Fig. 35):

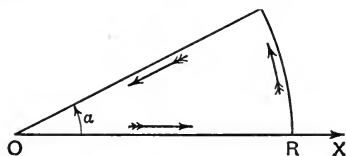

FIG. 35.

(1) the x -axis from O to R ;

(2) the circle $|z|=R$, from $\theta=0$ to $\theta=\alpha$, where $\alpha \leq \frac{\pi}{4}$;

(3) the line $\theta=\alpha$, from $|z|=R$ to O .

When R tends to infinity (1) gives $\int_0^\infty e^{-x^2} dx$ or $\frac{\sqrt{\pi}}{2}$.

On (2) $e^{-z^2} = e^{-R^2 \cos 2\theta} e^{-iR^2 \sin 2\theta}$; so that, if $2\theta = \pi/2 - \phi$,

$$\begin{aligned} \left| \int e^{-z^2} dz \right| &= \frac{R}{2} \int_\beta^{\frac{\pi}{2}} e^{-R^2 \sin \phi} d\phi, \quad \text{where } \beta = \pi/2 - 2\alpha \\ &< \frac{R}{2} \int_\beta^{\frac{\pi}{2}} e^{-\frac{2R^2}{\pi} \phi} d\phi \\ &< \frac{\pi}{4R} \left(e^{-\frac{2R^2}{\pi} \beta} - e^{-R^2} \right). \end{aligned}$$

Accordingly, when R tends to infinity, this integral tends to zero.

Again, on (3) $z = re^{i\alpha}$, and therefore, when R tends to infinity, the integral becomes

$$-\int_0^\infty e^{-r^2 \cos 2\alpha} \{ \cos(r^2 \sin 2\alpha) - i \sin(r^2 \sin 2\alpha) \} e^{i\alpha} dr.$$

But the integral is holomorphic within the contour; hence

$$\begin{aligned} \int_0^\infty e^{-r^2 \cos 2\alpha} \{ \cos(r^2 \sin 2\alpha) - i \sin(r^2 \sin 2\alpha) \} dr &= \frac{\sqrt{\pi}}{2} e^{-i\alpha} \\ &= \frac{\sqrt{\pi}}{2} (\cos \alpha - i \sin \alpha). \end{aligned}$$

Therefore, if the real and imaginary parts are equated,

$$\int_0^\infty e^{-x^2 \cos 2\alpha} \cos(x^2 \sin 2\alpha) dx = \frac{\sqrt{\pi}}{2} \cos \alpha,$$

and

$$\int_0^\infty e^{-x^2 \cos 2\alpha} \sin(x^2 \sin 2\alpha) dx = \frac{\sqrt{\pi}}{2} \sin \alpha.$$

If $\alpha = \pi/4$, these integrals become the *Fresnel Integrals*

$$\int_0^\infty \cos x^2 dx = \int_0^\infty \sin x^2 dx = \frac{\sqrt{2\pi}}{4}.$$

Example 6. Prove $\int_{-\infty}^{+\infty} \frac{e^{ax} dx}{1+e^x} = \frac{\pi}{\sin a\pi}$, where $0 < a < 1$.

Integrate $f(z) = e^{az}/(1+e^z)$ round the contour (Fig. 36) consisting of the

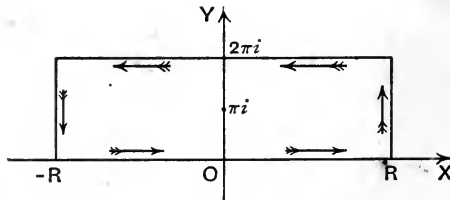

FIG. 36.

x -axis and the lines $x = \pm R$, $y = 2\pi$. The only pole within the contour is πi , at which the residue is $-e^{a\pi i}$.

If $z = R + iy$, then $|f(z)| \leq e^{\alpha R}/(e^R - 1)$, so that $\lim_{R \rightarrow \infty} f(z) = 0$; hence the integral along $x = R$ vanishes when R tends to infinity.

If $z = -R + iy$, then $|f(z)| \leq e^{-\alpha R}/(1 - e^{-R})$, so that $\lim_{R \rightarrow \infty} f(z) = 0$; thus the integral along $x = -R$ vanishes when R tends to infinity.

Therefore
$$\frac{1}{2\pi i} \int_{-\infty}^{+\infty} \frac{e^{\alpha x} dx}{1 + e^x} - \frac{1}{2\pi i} \int_{-\infty}^{+\infty} \frac{e^{\alpha(x+2\pi i)}}{1 + e^x} dx = -e^{\alpha \pi i}.$$

Hence
$$\frac{1 - e^{2\alpha \pi i}}{2\pi i} \int_{-\infty}^{+\infty} \frac{e^{\alpha x} dx}{1 + e^x} = -e^{\alpha \pi i}.$$

Therefore
$$\int_{-\infty}^{+\infty} \frac{e^{\alpha x} dx}{1 + e^x} = \frac{\pi}{\sin \alpha \pi}.$$

The transformation $e^x = y$ changes this integral into

$$\int_0^{\infty} \frac{y^{\alpha-1} dy}{1+y} = \frac{\pi}{\sin \alpha \pi}, \quad (0 < \alpha < 1).$$

Two methods can be employed to evaluate integrals of the type $\int_{-\pi}^{\pi} f(\cos \theta, \sin \theta) d\theta$, when $f(x, y)$ is rational in x and y .

The first is to use the transformation $x = \tan \frac{1}{2}\theta$. The integral then becomes an integral of the type $\int_{-\infty}^{+\infty} R(x) dx$, where $R(x)$ is rational in x .

The alternative method is to apply the transformation $z = e^{i\theta}$, and integrate round the circle $|z| = 1$.

Example 7. Prove $\int_0^{2\pi} \frac{d\theta}{a + b \cos \theta} = \frac{2\pi}{\sqrt{(a^2 - b^2)}}$, where the sign of $\sqrt{(a^2 - b^2)}$

is chosen to satisfy the inequality $|a - \sqrt{(a^2 - b^2)}| < |b|$; it is assumed that a/b is not a real number such that $-1 \leq a/b \leq 1$.

If $z = e^{i\theta}$,
$$\int_0^{2\pi} \frac{d\theta}{a + b \cos \theta} = \frac{2}{i} \int_C \frac{dz}{bz^2 + 2az + b} = \frac{2}{ib} \int_C \frac{dz}{(z - \alpha)(z - \beta)}$$

where C is the circle $|z| = 1$, and α and β are the roots of $bz^2 + 2az + b = 0$. Since $\alpha\beta = 1$, it follows that either $|\alpha|$ or $|\beta|$ is less than 1, or that $|\alpha| = |\beta| = 1$. The latter alternative is excluded, however, since in that case a/b would be real and such that $-1 \leq a/b \leq 1$. Let $\alpha = (-a + \sqrt{a^2 - b^2})/b$, where the sign selected for $\sqrt{a^2 - b^2}$ is that which makes $|\alpha| < 1$. Then

$$\int_0^{2\pi} \frac{d\theta}{a + b \cos \theta} = 2\pi i \frac{2}{ib} \frac{1}{\alpha - \beta} = \frac{2\pi}{\sqrt{a^2 - b^2}}$$

(3-4) f_1(z) z-a

THEOREM II. If $\lim_{z \rightarrow a} (z - a)f(z) = \kappa$, where κ is a constant, then $\lim_{r \rightarrow 0} \int f(z) dz$, the integral being taken round the arc $\theta_1 \leq \text{amp } z \leq \theta_2$ of the circle $|z - a| = r$, is $i(\theta_2 - \theta_1)\kappa$.

For, corresponding to any ϵ , an η can be found such that if $|z-a| < \eta$, $|\lambda| < \epsilon$, where $(z-a)f(z) = \kappa + \lambda$. Hence, since

$$\int f(z) dz = \int \frac{\kappa + \lambda}{z-a} dz = i \int_{\theta_1}^{\theta_2} (\kappa + \lambda) d\theta,$$

$$\left| \int f(z) dz - i(\theta_2 - \theta_1)\kappa \right| < \epsilon(\theta_2 - \theta_1).$$

Therefore $\lim_{r \rightarrow 0} \int f(z) dz = i(\theta_2 - \theta_1)\kappa$.

Example 8. Prove $\int_0^\infty \frac{\sin x}{x} dx = \frac{\pi}{2}$.

Integrate $f(z) = e^{iz}/z$ round the contour (Fig. 37) consisting of

- (1) the x -axis from r to R , where r is small and R large;
- (2) the upper half of the circle $|z| = R$;
- (3) the x -axis from $-R$ to $-r$;
- (4) the upper half of the circle $|z| = r$.

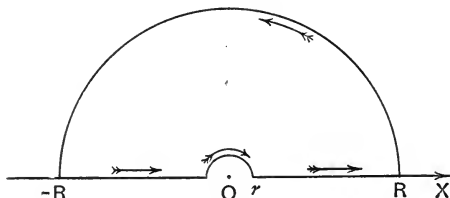

FIG. 37

Let I be the integral due to (2); then

$$I = \int_0^\pi e^{iR \cos \theta - R \sin \theta} i d\theta.$$

Hence $|I| < \int_0^\pi e^{-R \sin \theta} d\theta = 2 \int_0^{\frac{\pi}{2}} e^{-R \sin \theta} d\theta$

$$< 2 \int_0^{\frac{\pi}{2}} e^{-\frac{2R}{\pi} \theta} d\theta \doteq \frac{\pi}{R} (1 - e^{-R}).$$

Therefore $\lim_{R \rightarrow \infty} I = 0$.

Again, $\lim_{z \rightarrow 0} zf(z) = 1$, so that (Theorem II.) the integral along (4) tends to $-i\pi$ as r tends to zero.

Hence $\lim_{r \rightarrow 0} \left\{ \int_{-\infty}^{-r} \frac{e^{ix}}{x} dx + \int_r^\infty \frac{e^{ix}}{x} dx \right\} = \pi i$.

Therefore $\int_0^\infty \frac{\sin x}{x} dx = \frac{\pi}{2}$.

When, in the description of a contour, part of a small circle is described to avoid a singularity of the integrand, the contour

is said to be 'indented' at the singularity: for example, the contour of Fig. 37 is the contour of Fig. 33 indented at O.

Example 9. If $0 < p < 1$, prove $\int_0^\infty \frac{x^{p-1}}{1+x} dx = \frac{\pi}{\sin p\pi}$.

Integrate $f(z) = z^{p-1}/(1+z)$ round the contour (Fig. 38) consisting of:

- (1) the x -axis from r to R ; (2) the large circle $|z| = R$;
- (3) the x -axis from R to r ; (4) the small circle $|z| = r$.

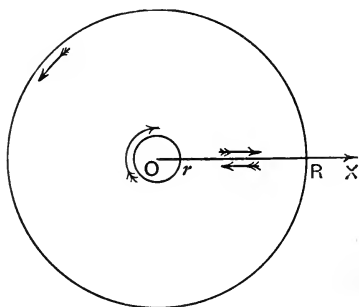

FIG. 38.

Within this contour $f(z)$ is uniform. Consider that branch for which $\text{amp } z = 0$ on (1).

Since $p > 0$, $\lim_{z \rightarrow 0} z f(z) = 0$: hence the value of the integral along (4) tends to zero as r tends to zero.

Again, when $|z| = R$, $|z f(z)| \leq R^p/(R-1)$: therefore, since $p < 1$, the integral along (2) tends to zero as R tends to infinity.

At the point -1 $\text{amp } z = \pi$: hence the residue at this point is $e^{(p-1)\pi i}$. Also on (3) $\text{amp } z = 2\pi$. Therefore

$$(1 - e^{2p\pi i}) \int_0^\infty \frac{x^{p-1}}{1+x} dx = 2\pi i e^{(p-1)\pi i}.$$

Hence
$$\int_0^\infty \frac{x^{p-1}}{1+x} dx = \frac{\pi}{\sin p\pi}.$$

The substitution $x = e^y$ transforms this integral into

$$\int_{-\infty}^{+\infty} \frac{e^{py} dy}{1 + e^y} = \frac{\pi}{\sin p\pi} \quad (0 < p < 1).$$

Principal Value of an Integral. If $f(z)$ is holomorphic in a region containing that part of the x -axis for which $a \leq x \leq b$, except for a simple pole at a point c on the x -axis, where $a < c < b$, then

$$\left\{ \int_a^{c-\epsilon} f(x) dx + \int_{c+\epsilon}^b f(x) dx \right\}$$

tends to a definite limit as ϵ tends to zero.

$$\text{For } \int_a^{c-\epsilon} \frac{dx}{x-c} + \int_{c+\epsilon}^b \frac{dx}{x-c} = \left[\log(c-x) \right]_a^{c-\epsilon} + \left[\log(x-c) \right]_{c+\epsilon}^b \\ = \log(b-c) - \log(c-a).$$

$$\text{Hence } \lim_{\epsilon \rightarrow 0} \left\{ \int_a^{c-\epsilon} \frac{dx}{x-c} + \int_{c+\epsilon}^b \frac{dx}{x-c} \right\} = \log \left(\frac{b-c}{c-a} \right).$$

Now, let $f(z) = \phi(z)/(z-c)$; then (§ 15, Theorem, p. 29)

$$f(z) = \frac{\phi(c)}{z-c} + \phi'(c) + \lambda,$$

where λ is continuous in the region. Therefore

$$\lim_{\epsilon \rightarrow 0} \left\{ \int_a^{c-\epsilon} f(x) dx + \int_{c+\epsilon}^b f(x) dx \right\} \\ = \phi(c) \log \left(\frac{b-c}{c-a} \right) + (b-a) \phi'(c) + \int_a^b \lambda dx.$$

This limit is called the Principal Value of $\int_a^b f(x) dx$, and is written

$$P \int_a^b f(x) dx.$$

Example 10. If $0 < a < 1$, prove

$$P \int_0^\infty \frac{x^{a-1}}{1-x} dx = \pi \cot a\pi.$$

Integrate $z^{a-1}/(z-1)$ round the contour of Fig. 38 indented at 1 (Fig. 39).

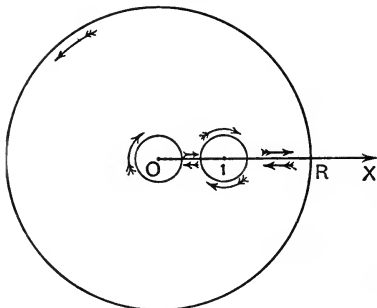

FIG. 39.

Example 11. If $-\pi < a < \pi$, prove

$$\int_0^\infty \frac{\sinh ax}{\sinh \pi x} dx = \frac{1}{2} \tan \frac{a}{2}.$$

Integrate $e^{az}/\sinh(\pi z)$ round the rectangle (Fig. 40) of sides $y=0$, $y=1$, $x=\pm R$, indented at O and i .

Example 12. Integrate $e^{ibz}/(r+iz)^a$, where $0 < a < 1$, $r > 0$, $b > 0$, round

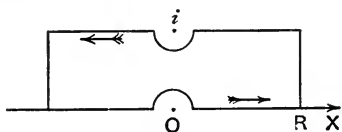

FIG. 40.

the contour of Fig. 41, where it is assumed that $\text{amp}(r+iz)$ is zero at points on the y -axis between 0 and ir ; and thus prove

$$\int_{-\infty}^{+\infty} \frac{e^{ibx}}{(r+ix)^a} dx = \frac{2\pi}{\Gamma(a)} b^{a-1} e^{-br}.$$

Prove also $\int_{-\infty}^{+\infty} \frac{e^{ibx}}{(r-ix)^a} dx = 0$; and shew that

$$\begin{aligned} \int_0^{\infty} \frac{(r-ix)^{-a} + (r+ix)^{-a}}{2} \cos bx \, dx \\ = \int_0^{\infty} \frac{(r-ix)^{-a} - (r+ix)^{-a}}{2i} \sin bx \, dx = \frac{\pi}{2\Gamma(a)} b^{a-1} e^{-br}. \end{aligned}$$

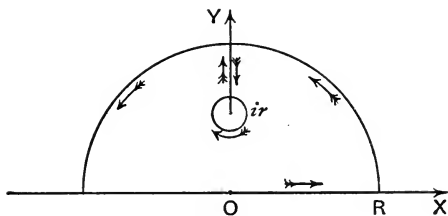

FIG. 41.

If $r=1$, $x = \tan \theta$, deduce

$$\begin{aligned} \int_0^{\frac{\pi}{2}} (\cos \theta)^{a-2} \cos a\theta \cos (b \tan \theta) d\theta \\ = \int_0^{\frac{\pi}{2}} (\cos \theta)^{a-2} \sin a\theta \sin (b \tan \theta) d\theta = \frac{\pi}{2\Gamma(a)} b^{a-1} e^{-br}. \end{aligned}$$

31. Theorem. Let C be a closed curve such that $f(z)$ is holomorphic within and on C and $\phi(z)$ is meromorphic within and has no singularities or zeros on C ; then

$$\frac{1}{2\pi i} \int_C f(z) \frac{\phi'(z)}{\phi(z)} dz = \sum r_1 f(a_1) - \sum s_1 f(b_1),$$

where a_1, a_2, a_3, \dots are the zeros of $\phi(z)$ within C of orders r_1, r_2, r_3, \dots respectively, and b_1, b_2, b_3, \dots are the poles of $\phi(z)$ within C of orders s_1, s_2, s_3, \dots respectively.

For $\phi(z) = (z - a_1)^{r_1} \psi(z)$, where $\psi(z)$ is holomorphic at a_1 ; hence

$$\phi'(z) = r_1(z - a_1)^{r_1-1} \psi(z) + (z - a_1)^{r_1} \psi'(z);$$

so that

$$\frac{\phi'(z)}{\phi(z)} = \frac{r_1}{z - a_1} + \frac{\psi'(z)}{\psi(z)}.$$

The residue of the integrand at a_1 is therefore

$$\lim_{z \rightarrow a_1} (z - a_1) f(z) \frac{\phi'(z)}{\phi(z)} = r_1 f(a_1).$$

Similarly, since $(z - b_1)^{s_1} \phi(z) = \chi(z)$, where $\chi(z)$ is holomorphic at b_1 , the residue at b_1 is $-s_1 f(b_1)$.

Hence
$$\frac{1}{2\pi i} \int_C f(z) \frac{\phi'(z)}{\phi(z)} dz = \Sigma r_1 f(a_1) - \Sigma s_1 f(b_1).$$

COROLLARY 1.
$$\frac{1}{2\pi i} \int_C \frac{\phi'(z)}{\phi(z)} dz = \Sigma r_1 - \Sigma s_1.$$

COROLLARY 2.
$$\frac{1}{2\pi i} \int_C z \frac{\phi'(z)}{\phi(z)} dz = \Sigma r_1 a_1 - \Sigma s_1 b_1.$$

Example 1. If $\phi(z)$ is a polynomial of degree n , shew that $\Sigma r_1 = n$.

Example 2. If $\phi(z)$ is a polynomial with factors $z - \alpha, z - \beta, \dots$, shew that $\alpha^{-k} + \beta^{-k} + \dots = -R$, where k is any positive non-zero integer, and R is the residue of $\frac{1}{z^k} \frac{\phi'(z)}{\phi(z)}$ at $z = 0$.

32. Liouville's Theorem. A function which is holomorphic at all points of the plane, including infinity, must be a constant.

Let $f(z)$ be such a function; then, if a and b are any two distinct points, the only singularities of the function

$$F(z) = \frac{f(z)}{(z - a)(z - b)}$$

are a and b , and possibly infinity. But since $\lim_{z \rightarrow \infty} zF(z) = 0$, the residue of $F(z)$ at infinity is zero (§ 29, p. 58). Now the sum of all the residues is zero (§ 29, Theorem 2): hence

$$\frac{f(a)}{a - b} + \frac{f(b)}{b - a} = 0,$$

so that $f(a) = f(b)$; and therefore, since a and b are arbitrary points, $f(z)$ is a constant.

COROLLARY. Every function which is not a constant must have at least one singularity.

33. The Fundamental Theorem of Algebra. If $f(z)$ is a polynomial in z , the equation $f(z) = 0$ has a root.

For, if not, the function $1/f(z)$ would be finite and holomorphic for all values of z , and would therefore be a constant (Liouville's Theorem). Hence $f(z)$ would be a constant, which contradicts our hypothesis.

34. Differentiation under the Integral Sign. Let the function $f(z, \xi)$ of the two independent complex variables z and ξ be holomorphic with regard to both z and ξ so long as z lies in a region A of the z -plane and ξ in a region A' of the ξ -plane. Then the function $\phi(\xi) = \int_C f(z, \xi) dz$, where C lies entirely in A , is holomorphic at all points of A' , and $\phi'(\xi) = \int_C \frac{\partial}{\partial \xi} f(z, \xi) dz$.

Let $f(z, \xi) = u + iv$ and $\phi(\xi) = P + iQ$,

so that $P = \int_C (u dx - v dy)$, $Q = \int_C (v dx + u dy)$;

then (§ 24),

$$\frac{\partial P}{\partial \xi} = \int_C \left(\frac{\partial u}{\partial \xi} dx - \frac{\partial v}{\partial \xi} dy \right), \quad \frac{\partial P}{\partial \eta} = \int_C \left(\frac{\partial u}{\partial \eta} dx - \frac{\partial v}{\partial \eta} dy \right),$$

$$\frac{\partial Q}{\partial \xi} = \int_C \left(\frac{\partial v}{\partial \xi} dx + \frac{\partial u}{\partial \xi} dy \right), \quad \frac{\partial Q}{\partial \eta} = \int_C \left(\frac{\partial v}{\partial \eta} dx + \frac{\partial u}{\partial \eta} dy \right).$$

Hence (equations (A), § 15),

$$\frac{\partial P}{\partial \xi} = \frac{\partial Q}{\partial \eta}, \quad \frac{\partial P}{\partial \eta} = -\frac{\partial Q}{\partial \xi}.$$

Thus $\phi(\xi)$ is a holomorphic function of ξ : its derivative is given by

$$\frac{d\phi(\xi)}{d\xi} = \frac{\partial \phi(\xi)}{\partial \xi} = \int_C \left(\frac{\partial u}{\partial \xi} + i \frac{\partial v}{\partial \xi} \right) (dx + i dy) = \int_C \frac{\partial f(z, \xi)}{\partial \xi} dz.$$

Example. Integration under the Integral Sign. Shew that, if C and C' lie in A and A' respectively,

$$\int_{C'} \int_C f(z, \xi) dz d\xi = \int_C \int_{C'} f(z, \xi) d\xi dz.$$

Let ξ_0 and ξ be the lower and upper extremities of C' ; then $\int_C \int_{C'} f(z, \xi) d\xi dz$ is holomorphic in ξ , and

$$\frac{\partial}{\partial \xi} \int_C \int_{C'} f(z, \xi) d\xi dz = \int_C f(z, \xi) dz = \phi(\xi).$$

$$\begin{aligned} \text{Hence } \int_C \phi(\xi) d\xi &= \int_C \int_C f(z, \xi) d\xi dz - \left[\int_C \int_C f(z, \xi) d\xi dz \right]_{\xi=\xi_0} \\ &= \int_C \int_C f(z, \xi) d\xi dz. \end{aligned}$$

35. Derivatives of a Holomorphic Function. A function $f(z)$ which is holomorphic in a simply-connected region enclosed by a curve C , possesses derivatives of all orders at every point interior to C .

For, if z is any point interior to C ,

$$f(z) = \frac{1}{2\pi i} \int_C \frac{f(\xi) d\xi}{\xi - z}.$$

Now let A be a region which contains the point z , and whose boundary is interior to C . Then the function $f(\xi)/(\xi - z)$ is holomorphic with regard to both ξ and z so long as ξ remains on C and z in A . Hence (§ 34),

$$f'(z) = \frac{1}{2\pi i} \int_C \frac{f'(\xi) d\xi}{(\xi - z)^2}.$$

Similarly, by means of repeated differentiations, it can be shewn that

$$f^{(n)}(z) = \frac{n!}{2\pi i} \int_C \frac{f(\xi) d\xi}{(\xi - z)^{n+1}}, \quad n = 1, 2, 3, \dots$$

COROLLARY 1. If C is a circle of centre z and radius R , and M is the maximum value of $|f(z)|$ on C , $|f^{(n)}(z)| \leq n! M/R^n$.

COROLLARY 2. If $f(z)$ is continuous at all points of a finite (not necessarily closed) path C , the function

$$\int_C \frac{f(\xi) d\xi}{\xi - z}$$

is holomorphic in z at all points which do not lie on C , and its n^{th} derivative is

$$n! \int_C \frac{f(\xi) d\xi}{(\xi - z)^{n+1}}.$$

COROLLARY 3. If $u(x, y) + iv(x, y)$ is a holomorphic function of $z = x + iy$, then $u(x, y)$ and $v(x, y)$ have partial derivatives of all orders.

EXAMPLES IV.

1. Prove $\int_{z_0}^z \frac{dz}{z} = \log \frac{z}{z_0}$, a cross-cut being taken along the negative real axis.

2. Under the same restriction as in the previous example, prove

$$\int_{z_0}^z z^n dz = \frac{z^{n+1} - z_0^{n+1}}{n+1},$$

where n may have any value except -1 , and the same branch of z^n is taken on both sides of the equation.

3. Prove $\int_0^z e^{az} dz = (e^{az} - 1)/a$.

4. Prove $\int_0^z \cos az dz = \sin(az)/a$.

5. Shew that the residue of $e^{az}/(1+e^z)$ at πi is $-e^{a\pi i}$.

6. If κ is any integer, shew that the residue of $\cot z$ at $\kappa\pi$ is 1.

7. Shew that the residues of $e^{zi}/(z^2+a^2)$ and $ze^{zi}/(z^2+a^2)$ at ai are $e^{-a}/2ai$ and $e^{-a}/2$ respectively.

8. Shew that the sum of the residues of any rational function is zero.

9. If $f(z) = \frac{A_1}{z-a} + \frac{A_2}{(z-a)^2} + \dots + \frac{A_n}{(z-a)^n}$, shew that the residue of $f(z)/(z-x)$ at a is $-f(x)$.

10. If $f(z) = \sum_1^n A_r(z-a)^r + \phi(z)$, where $\phi(z)$ is holomorphic near a , shew that the residue of $f(z)/(z-x)$ at a is $-\sum_1^n A_r/(x-a)^r$.

11. Shew that, if m and n are positive integers, and $m < n$,

$$\int_0^\infty \frac{x^{2m}}{x^{2n}+1} dx = \frac{\pi}{2n \sin\left(\frac{2m+1}{2n}\pi\right)}.$$

12. Integrate $ze^{imz}/(z^4+a^4)$, where m and a are positive, round the contour of Fig. 33, and shew that

$$\int_0^\infty \frac{x \sin mx}{x^4+a^4} dx = \frac{\pi}{2a^2} e^{-\frac{ma}{\sqrt{2}}} \sin \frac{ma}{\sqrt{2}}.$$

13. Prove $\int_0^\infty \frac{\cos mx}{x^4+a^4} dx = \frac{\pi}{2a^3} e^{-\frac{ma}{\sqrt{2}}} \sin\left(\frac{ma}{\sqrt{2}} + \frac{\pi}{4}\right)$.

✓ 14. Integrate $e^{iz}/(z-ai)$, where $a > 0$, over the contour of Fig. 33, and shew that

$$\int_{-\infty}^{+\infty} \frac{a \cos x + x \sin x}{x^2+a^2} dx = 2\pi e^{-a}.$$

15. By integrating $e^{iz}/(z+ai)$, where $a > 0$, prove

$$\int_{-\infty}^{+\infty} \frac{-a \cos x + x \sin x}{x^2+a^2} dx = 0.$$

16. Prove $\int_0^\infty \frac{x^3 \sin mx}{x^4+a^4} dx = \frac{\pi}{2} e^{-\frac{ma}{\sqrt{2}}} \cos \frac{ma}{\sqrt{2}}$, where $m > 0$.

17. If $0 < a < 2$, shew that

$$(i) \int_0^{\infty} \frac{x^{a-1} dx}{1+x+x^2} = \frac{2\pi}{\sqrt{3}} \frac{\cos\left(\frac{2\pi a + \pi}{6}\right)}{\sin \pi a};$$

$$(ii) \int_0^{\infty} \frac{x^{a-1} dx}{1-x+x^2} = \frac{2\pi}{\sqrt{3}} \frac{\sin\left(\frac{2\pi a + \pi}{3}\right)}{\sin \pi a}.$$

[Integrate $\frac{z^{a-1}}{1+z+z^2}$ round the contour of Fig. 37, and equate real and imaginary parts.]

$$18. \text{ Prove } \int_0^{\frac{\pi}{2}} \frac{r \sin 2\theta}{1-2r \cos 2\theta+r^2} \theta d\theta = \frac{\pi}{4} \log(1+r), \text{ if } -1 < r < 1$$

$$= \frac{\pi}{4} \log\left(1 + \frac{1}{r}\right), \text{ if } r < -1 \text{ or } r > 1.$$

[Integrate $\frac{2zr}{z^2(1+r)^2+(1-r)^2} \frac{\log(1-iz)}{1+z^2}$ round the contour of Fig. 33, and put $x = \tan \theta$.]

19. If $a > 0$, and $-\pi/2 < \theta < \pi/2$, prove

$$\int_0^{\infty} x^{a-1} e^{-x \cos \theta} \cos(x \sin \theta) dx = \cos(a\theta) \Gamma(a),$$

and $\int_0^{\infty} x^{a-1} e^{-x \cos \theta} \sin(x \sin \theta) dx = \sin(a\theta) \Gamma(a).$

[Integrate $z^{a-1} e^{-z}$ round the contour consisting of the positive x -axis, the line $\text{amp } z = \theta$, and part of an infinite circle.]

20. If $a \geq 0$, prove

$$(i) \int_0^{\infty} \frac{(1+x^2) \cos ax}{1+x^2+x^4} dx = \frac{\pi}{\sqrt{3}} e^{-\frac{\sqrt{3}}{2}a} \cos \frac{a}{2};$$

$$(ii) \int_0^{\infty} \frac{x \sin ax}{1+x^2+x^4} dx = \frac{\pi}{\sqrt{3}} e^{-\frac{\sqrt{3}}{2}a} \sin \frac{a}{2}.$$

[Integrate $e^{iaz}/(1+z+z^2)$ round the contour of Fig. 33.]

21. Integrate e^{-z^2} round the rectangle of sides $y=0$, $y=b$, $x=\pm R$, and show that

$$\int_{-x}^{+x} e^{-(x+bi)^2} dx = \int_{-x}^{+x} e^{-x^2} dx = \sqrt{\pi}.$$

Deduce: (i) $\int_0^{\infty} e^{-x^2} \cos 2bx dx = \frac{\sqrt{\pi}}{2} e^{-b^2};$

(ii) $\int_{-x}^{+x} e^{-(x+c)^2} dx = \sqrt{\pi}$, where c is any constant.

22. Integrate $e^{iz}/(z+a)$, where $a > 0$, round the square whose sides are $x=0$, $x=R$, $y=0$, $y=R$, and shew that:

$$(i) \int_0^{\infty} \frac{\cos x}{x+a} dx = \int_0^{\infty} \frac{x e^{-ax}}{1+x^2} dx;$$

$$(ii) \int_0^{\infty} \frac{\sin x}{x+a} dx = \int_0^{\infty} \frac{e^{-ax}}{1+x^2} dx.$$

23. Integrate e^{-z^2} round the rectangle whose sides are $x=0$, $x=R$, $y=0$, $y=b$, where $b > 0$, and shew that :

$$(i) \int_0^x e^{-x^2} \cos 2bx \, dx = \frac{\sqrt{\pi}}{2} e^{-b^2};$$

$$(ii) \int_0^x e^{-x^2} \sin 2bx \, dx = e^{-b^2} \int_0^b e^{x^2} \, dx.$$

24. Integrate $e^{az}/\cosh \pi z$ round the rectangle of sides $x = \pm R$, $y=0$, $y=1$ and shew that

$$\int_0^\infty \frac{\cosh ax}{\cosh \pi x} \, dx = \frac{1}{2} \sec \frac{a}{2}, \quad \text{where } -\pi < a < \pi.$$

25. Prove
$$\int_0^{2\pi} \cot \frac{\theta - a - bi}{2} \, d\theta = \begin{cases} 2\pi i, & \text{if } b > 0, \\ -2\pi i, & \text{if } b < 0. \end{cases}$$

26. Prove
$$\int_0^{2\pi} \cos^n \theta \, d\theta = \begin{cases} 0, & \text{if } n \text{ is odd, and} \\ = \frac{1 \cdot 3 \cdot 5 \dots (n-1)}{2 \cdot 4 \cdot 6 \dots n} 2\pi, & \text{if } n \text{ is even.} \end{cases}$$

27. Prove that, if γ is the unit of circular measure :

$$(i) \int_{-\infty}^{+\infty} \frac{\sin x}{x(x^2 - 2x + 2)} \, dx = \frac{\pi}{2e} (e - \cos \gamma + \sin \gamma);$$

$$(ii) \int_{-\infty}^{+\infty} \frac{1 - \cos x}{x(x^2 - 2x + 2)} \, dx = \frac{\pi}{2e} (e - \cos \gamma - \sin \gamma).$$

28. If a is positive, prove

$$(i) \text{P} \int_0^\infty \frac{r \cos ax}{x^2 - r^2} \, dx = -\frac{\pi}{2} \sin ar; \quad (ii) \text{P} \int_0^\infty \frac{x \sin ax}{x^2 - r^2} \, dx = \frac{\pi}{2} \cos ar.$$

29. If r and b are positive, and $0 < a < 2$, prove

$$(i) \int_0^\infty x^{a-1} \sin \left(\frac{a\pi}{2} - bx \right) \frac{dx}{x^2 + r^2} = \frac{\pi}{2} r^{a-2} e^{-br};$$

$$(ii) \int_0^\infty x^{a-1} \sin \left(\frac{a\pi}{2} - bx \right) \frac{dx}{r^2 - x^2} = \frac{\pi}{2} r^{a-2} \cos \left(\frac{a\pi}{2} - br \right).$$

[Integrate (i) $z^{a-1} e^{ibz}/(z^2 + r^2)$ round the contour of Fig. 37, and

(ii) $z^{a-1} e^{ibz}/(z^2 - r^2)$ round this contour indented at r and $-r$.]

30. If $-1 < a < 1$, prove

$$\begin{aligned} \int_0^{\frac{\pi}{2}} \frac{1 - r \cos 2\theta}{1 - 2r \cos 2\theta + r^2} (\tan \theta)^a \, d\theta &= \int_0^{\frac{\pi}{2}} \frac{1 + r \cos 2\theta}{1 + 2r \cos 2\theta + r^2} (\cot \theta)^a \, d\theta \\ &= \frac{\pi}{4 \cos \frac{1}{2} a \pi} \left\{ 1 + \left(\frac{1-r}{1+r} \right)^a \right\}, \quad \text{if } -1 < r < 1, \\ &= \frac{\pi}{4 \cos \frac{1}{2} a \pi} \left\{ 1 - \left(\frac{r-1}{r+1} \right)^a \right\}, \quad \text{if } r < -1, \text{ or } r > 1. \end{aligned}$$

Deduce that, if $-1 < a < 1$,

$$\int_0^{\frac{\pi}{2}} (\tan \theta)^a \, d\theta = \int_0^{\frac{\pi}{2}} (\cot \theta)^a \, d\theta = \frac{\pi}{2 \cos \frac{1}{2} a \pi}.$$

[Integrate $\frac{z^2(1+r) + (1-r)}{z^2(1+r)^2 + (1-r)^2} \frac{z^a}{1+z^2}$ round the contour of Fig. 37, and put $x = \tan \theta$.]

31. Prove

$$\int_0^{\frac{\pi}{2}} \frac{1-r \cos 2\theta}{1-2r \cos 2\theta+r^2} \log \tan \theta \, d\theta = \frac{\pi}{4} \log \left(\frac{1-r}{1+r} \right), \text{ if } -1 < r < 1,$$

$$= -\frac{\pi}{4} \log \left(\frac{r-1}{r+1} \right), \text{ if } r < -1, \text{ or } r > 1.$$

[Integrate $\frac{(1-r)+z^2(1+r)}{(1-r)^2+z^2(1+r)^2} \frac{\log z}{1+z^2}$ round the contour of Fig. 37.]

32. If $a > 0$, prove $\int_0^{\infty} \frac{\sin x \, dx}{x(x^2+a^2)} = \frac{\pi}{2a^2}(1-e^{-a})$.33. If $a > 0$, prove

$$\int_0^{\infty} \frac{\pi(1-\cos ax) - 2 \log x \sin ax}{x\{(\log x)^2 + \pi^2/4\}} \, dx = 2\pi(1-e^{-a}).$$

[Integrate $\frac{1-e^{iaz}}{z(\log z - i\pi/2)}$ round the contour of Fig. 37.]

34. If $a > 0$, prove

$$\int_{-\frac{\pi}{2}}^{\frac{\pi}{2}} \frac{\{1 - \cos(a \tan \theta)\} \theta + \log(\cos \theta) \sin(a \tan \theta)}{(\log \cos \theta)^2 + \theta^2} \frac{d\theta}{\sin 2\theta} = \frac{\pi a}{2}.$$

[Integrate $\frac{1-e^{iaz}}{z \log(1-iz)}$ round the contour of Fig. 37.]

35. If $b > 0$, $r > 0$ and $0 < a < 2$, shew that

$$\int_0^{\infty} x^{a-1} e^{\cos bx} \sin \left(\frac{a\pi}{2} - \sin bx \right) \frac{dx}{x^2+r^2} = \frac{\pi}{2} r^{a-2} e^{-br}.$$

[Integrate $z^{a-1} e^{ibz}/(z^2+r^2)$ round the contour of Fig 37.]

36. If $0 < a < 2$, prove $\int_0^{\infty} \frac{x^{a-1}}{1+x^2} \, dx = \pi / \left(2 \sin \frac{\pi a}{2} \right)$.Deduce (i) $\int_0^{\infty} \frac{(\log x)^2 \, dx}{1+x^2} = \frac{\pi^3}{8}$;

$$(ii) \int_0^{\infty} \frac{x^{a-1} - x^{b-1}}{\log x} \frac{dx}{1+x^2} = \log \left(\tan \frac{\pi a}{4} / \tan \frac{\pi b}{4} \right),$$

where $0 < b < 2$.

37. Let $P(z)$ and $Q(z)$ be polynomials of degree m and n respectively, where $m \leq n-2$, and let $Q(z)$ have no positive or zero real roots. By means of the integral of $P(z) \operatorname{Log} z/Q(z)$ taken round the contour of Fig. 38, prove

$$\int_0^{\infty} \frac{P(x)}{Q(x)} \, dx = -R,$$

where R denotes the sum of the residues of $P(z) \operatorname{Log} z/Q(z)$ ($0 < \operatorname{amp} z < 2\pi$) at the zeros of $Q(z)$.

38. By integrating $(\operatorname{Log} z)^2/(1+z^2)$ round the contour of Fig. 38, prove

$$\int_0^{\infty} \frac{\log x}{1+x^2} \, dx = 0.$$

39. By integrating $\log(z+i)/(z^2+1)$ round the contour of Fig. 33, prove

$$\int_0^{\infty} \frac{\log(1+x^2)}{1+x^2} \, dx = \pi \log 2.$$

Deduce

$$\int_0^1 \frac{\log(x+1/x)}{1+x^2} \, dx = \frac{\pi}{2} \log 2.$$

40. Prove
$$\int_0^{\infty} \frac{x}{\sinh x} dx = \frac{\pi^2}{4}.$$

41. If a is real, show that

(i) $\int_0^{\infty} \frac{\sin ax}{\sinh x} dx = \frac{\pi}{2} \tanh \frac{a\pi}{2}$; (ii) $\int_0^{\infty} \frac{x \cos ax}{\sinh x} dx = \frac{\pi^2 e^{-a\pi}}{(1 + e^{-a\pi})^2}.$

42. If $m > -1$, $n > -1$, and $m - n$ is an even positive integer, prove

$$\int_0^{\infty} \frac{\sin mx - \sin nx}{(1+x^2)\sin x} dx = \pi \frac{e^{-n} - e^{-m}}{e - e^{-1}}.$$

43. Prove
$$\int_0^{\infty} \frac{(\log x)^2}{1+x+x^2} dx = \frac{16}{81\sqrt{3}}\pi^3.$$

[Integrate $(\text{Log } z)^3/(1+z+z^2)$ round the contour of Fig. 38.]

44. If $-1 < p < 1$ and $-\pi < \lambda < \pi$, shew that

$$\int_0^{\infty} \frac{x^{-p} dx}{1+2x \cos \lambda + x^2} = \frac{\pi}{\sin p\pi} \frac{\sin p\lambda}{\sin \lambda}.$$

45. Prove
$$\int_0^{\pi} \frac{x \sin x}{u^2 - 2u \cos x + 1} dx = \frac{\pi}{u} \log(1+u), \text{ if } 0 < u < 1,$$

$$= \frac{\pi}{u} \log\left(1 + \frac{1}{u}\right), \text{ if } u > 1.$$

[Integrate $z/(u - e^{-iz})$ round the rectangle of sides $x = \pm \pi, y = 0, y = R.$]

46. If $r > 0, s > 0, 0 < a < 1, 0 < b < 1, a + b > 1$, shew that

(i) $\int_{-\infty}^{+\infty} \frac{dx}{(r+ix)^a (s-ix)^b} = \int_{-\infty}^{+\infty} \frac{dx}{(r-ix)^a (s+ix)^b} = 2\pi(r+s)^{1-a-b} \frac{\Gamma(a+b-1)}{\Gamma(a)\Gamma(b)}$;
 (ii) $\int_{-\infty}^{+\infty} \frac{!dx}{(r-ix)^a (s-ix)^b} = \int_{-\infty}^{+\infty} \frac{dx}{(r+ix)^a (s+ix)^b} = 0.$

Deduce
$$\int_0^{\frac{\pi}{2}} (\cos \theta)^{a+b-2} \cos(b-a)\theta d\theta = \frac{\pi}{2^{a+b-1}} \frac{\Gamma(a+b-1)}{\Gamma(a)\Gamma(b)}.$$

47. By integrating e^{iz}/z round a suitable contour, shew that

$$\int_0^{\infty} \frac{\sin x^2}{x} dx = \frac{\pi}{4}.$$

Deduce
$$\int_0^{\infty} \frac{\sin x}{x} dx = \frac{\pi}{2}.$$

48. By integrating e^{iz}/\sqrt{z} along a suitable path, shew that

$$\int_0^{\infty} \frac{\cos x}{\sqrt{x}} dx = \int_0^{\infty} \frac{\sin x}{\sqrt{x}} dx = \sqrt{\frac{\pi}{2}}.$$

49. If $0 < \alpha < \pi/2$, shew that

$$\int_{-\infty}^{+\infty} \frac{\tan^{-1} x dx}{x^2 - 2x \sin \alpha + 1} = \frac{\pi \alpha}{2 \cos \alpha}.$$

[Integrate $\log(1-iz)/(z^2 - 2z \sin \alpha + 1)$ round the contour of Fig. 33.]

50. Integrate $e^{iaz}/(e^{2\pi z} - 1)$, where a is real, round the rectangle of sides $x=0, x=R, y=0, y=1$, indented at 0 and i , and shew that

$$\int_0^{\infty} \frac{\sin ax}{e^{2\pi x} - 1} dx = \frac{1}{4} \coth\left(\frac{a}{2}\right) - \frac{1}{2a}.$$

CHAPTER V.

CONVERGENCE OF SERIES: TAYLOR'S AND LAURENT'S SERIES.

36.* Convergence of Series. Let S_n denote the sum of the first n terms of the infinite series $\sum_{n=1}^{\infty} w_n$, where the w 's are real or complex quantities; then, if S_n tends to a finite limit S as n tends to infinity, the series is said to converge or to be convergent and to have the sum S . The necessary and sufficient condition for this is (§ 23) that a number m can be found such that, when $n \geq m$ and p is any positive integer,

$$|S_{n+p} - S_n| < \epsilon \quad \text{or} \quad |w_{n+1} + w_{n+2} + \dots + w_{n+p}| < \epsilon.$$

If $w_n = u_n + iv_n$, the series $\sum u_n$ and $\sum v_n$ converge to the real values U and V , where $U + iV = S$; for $\left| \sum_1^n u_n - U \right|$ and $\left| \sum_1^n v_n - V \right|$ are both less than $|S_n - S|$. Conversely, if the series $\sum u_n$ and $\sum v_n$ converge to the values U and V , the series $\sum (u_n + iv_n)$ will converge to the value $U + iV$, since

$$\left| \sum_1^n (u_n + iv_n) - (U + iV) \right| \leq \left| \sum_1^n u_n - U \right| + \left| \sum_1^n v_n - V \right|.$$

Absolute Convergence. If the series of moduli $\sum_{n=1}^{\infty} |w_n|$ is convergent, the series $\sum w_n$ is also convergent, since

$$|w_{n+1} + w_{n+2} + \dots + w_{n+p}| \leq |w_{n+1}| + |w_{n+2}| + \dots + |w_{n+p}|;$$

a series of this kind is said to be Absolutely Convergent. The series $\sum u_n$ and $\sum v_n$ are then also absolutely convergent, since

*In this and the following paragraphs some definitions and theorems on infinite series which will be found useful in the course of this work are summarised; for fuller proofs and for further information on the subject reference may be made to Bromwich's *Theory of Infinite Series*.

$|u_n| \leq |w_n|$ and $|v_n| \leq |w_n|$. Conversely, if $\sum u_n$ and $\sum v_n$ are absolutely convergent, $\sum w_n$ will be absolutely convergent, since $|w_n| \leq |u_n| + |v_n|$.

Note. The value of an absolutely convergent series is independent of the arrangement of the terms.*

Multiplication of Series. Since

$$(u_n + iv_n)(u'_m + iv'_m) = u_n u'_m - v_n v'_m + i u_n v'_m + i v_n u'_m,$$

the product of the two absolutely convergent series $\sum w_n$ and $\sum w'_n$ is equivalent to

$$\sum u_n \sum u'_m - \sum v_n \sum v'_m + i \sum u_n \sum v'_m + i \sum v_n \sum u'_m.$$

Hence the product is the absolutely convergent series

$$w_1 w'_1 + (w_1 w'_2 + w_2 w'_1) + (w_1 w'_3 + w_2 w'_2 + w_3 w'_1) + \dots$$

Most of the series with which we shall have to deal will be absolutely convergent series. The tests for convergence of series of positive terms apply also to absolutely convergent series: the most important of these is:

The Ratio Test. If $\lim_{n \rightarrow \infty} |w_{n+1}/w_n| < 1$, the series $\sum_1^\infty w_n$ is absolutely convergent: if $\lim_{n \rightarrow \infty} |w_{n+1}/w_n| > 1$, the series is divergent.

If $\lim_{n \rightarrow \infty} |w_{n+1}/w_n| = 1$, further tests must be applied: one such test† is the following:

$$\text{If } \left| \frac{w_n}{w_{n+1}} \right| = 1 + \frac{\mu}{n} + \frac{\omega_n}{n^2},$$

where μ is a constant and $|\omega_n|$ is less than a fixed number A for all values of n , the series $\sum |w_n|$ is convergent if $\mu > 1$ and divergent if $\mu \leq 1$.

Example 1. Shew that the **Hypergeometric Series**

$$\begin{aligned} F(\alpha, \beta, \gamma, z) \equiv & 1 + \frac{\alpha \cdot \beta}{1 \cdot \gamma} z + \frac{\alpha(\alpha+1)\beta(\beta+1)}{1 \cdot 2 \cdot \gamma(\gamma+1)} z^2 \\ & + \frac{\alpha(\alpha+1)(\alpha+2)\beta(\beta+1)(\beta+2)}{1 \cdot 2 \cdot 3 \cdot \gamma(\gamma+1)(\gamma+2)} z^3 + \dots \end{aligned}$$

is absolutely convergent if $|z| < 1$ and is divergent if $|z| > 1$; while, if $|z| = 1$, it converges absolutely if $R(\gamma - \alpha - \beta) > 0$.

* Cf. Bromwich, § 76.

† Cf. Bromwich, §§ 12, 79.

Example 2. If $R(\gamma - \alpha - \beta) > 0$, prove

$$F(\alpha, \beta, \gamma, 1) = \frac{(\gamma - \alpha)(\gamma - \beta)}{\gamma(\gamma - \alpha - \beta)} F(\alpha, \beta, \gamma + 1, 1).$$

Let T_n denote the n th term of $F(\alpha, \beta, \gamma, 1)$; then, if $n = 1, 2, 3, \dots$,

$$\begin{aligned} T_{n+1} - T_{n+2} &= \left(1 - \frac{\beta}{\gamma}\right) \frac{\alpha(\alpha+1) \dots (\alpha+n-1) \beta(\beta+1) \dots (\beta+n-1)}{1 \cdot 2 \dots n(\gamma+1)(\gamma+2) \dots (\gamma+n)} \\ &\quad - \frac{(\alpha-1)\alpha \dots (\alpha+n-1) \beta(\beta+1) \dots (\beta+n)}{1 \cdot 2 \dots (n+1)\gamma(\gamma+1) \dots (\gamma+n)} \\ &= \left(1 - \frac{\beta}{\gamma}\right) T'_{n+1} - T''_{n+2}, \end{aligned}$$

where T'_n and T''_n are the n th terms of $F(\alpha, \beta, \gamma + 1, 1)$ and $F(\alpha - 1, \beta, \gamma, 1)$ respectively. Also

$$-T_2 = \left(1 - \frac{\beta}{\gamma}\right) T'_1 - (T''_1 + T_2).$$

Hence, since $\lim_{n \rightarrow \infty} T_n = 0$,

$$\gamma F(\alpha - 1, \beta, \gamma, 1) = (\gamma - \beta) F(\alpha, \beta, \gamma + 1, 1).$$

Again, if $n = 1, 2, 3, \dots$,

$$(\gamma - \alpha) T_{n+1} - \beta T_n + n T_{n+1} - (n-1) T_n = (\gamma - \alpha) T''_{n+1};$$

so that $(\gamma - \alpha - \beta) F(\alpha, \beta, \gamma, 1) = (\gamma - \alpha) F(\alpha - 1, \beta, \gamma, 1)$.

Hence $F(\alpha, \beta, \gamma, 1) = \frac{(\gamma - \alpha)(\gamma - \beta)}{\gamma(\gamma - \alpha - \beta)} F(\alpha, \beta, \gamma + 1, 1)$.

Example 3. Shew that, if the series $\sum_1^{\infty} w_n$ is absolutely convergent, the series $\sum_1^{\infty} \log(1 + w_n)$ is also absolutely convergent.

Choose n so large that $|w_n| < 1$: then

$$|\log(1 + w_n)| \leq |w_n| + \frac{|w_n|^2}{2} + \dots \leq \frac{|w_n|}{1 - |w_n|}.$$

Hence an m can be found such that, for $n \geq m$,

$$|\log(1 + w_n)| \leq C |w_n|,$$

where C is a constant independent of n .

Therefore, if $\sum_m^{m+p} |w_n| < \epsilon$, $\sum_m^{m+p} |\log(1 + w_n)| < C\epsilon$;

so that the series $\sum_1^{\infty} \log(1 + w_n)$ is absolutely convergent.

37. Convergence of a Double Series. If ω_1 and ω_2 are complex quantities such that ω_2/ω_1 is not real, the double series

$$\sum_{m=-\infty}^{+\infty} \sum_{n=-\infty}^{+\infty} \frac{1}{(2m\omega_1 + 2n\omega_2)^3}$$

is absolutely convergent. The accent indicates that the term for which $m = n = 0$ is omitted. It is convenient to assume $I(\omega_2/\omega_1) > 0$: if this is not the case, interchange ω_1 and ω_2 .

Divide up the plane (Fig. 42) by parallel and equidistant lines into parallelograms similar and equal to parallelogram OABC, where A, B, and C are the points $2\omega_1$, $2\omega_1 + 2\omega_2$, and $2\omega_2$. Since $I(\omega_2/\omega_1) > 0$, the angle AOC lies between 0 and π . One term of

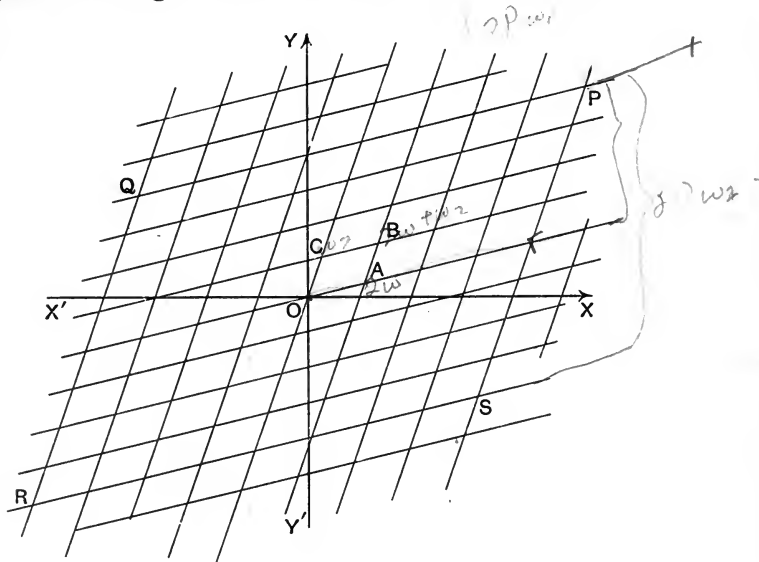

FIG. 42.

the series corresponds to each angular point of the net-work, except the origin.

Consider those angular points which lie on the parallelogram PQRS, the mid-points of whose sides are $\pm 2p\omega_1$, $\pm 2p\omega_2$, where p is a positive integer. There are $2p+1$ points on each of the sides, and therefore, since the four vertices each lie on two sides, there are $8p$ angular points on the parallelogram.

Now let d be the shorter of the two perpendiculars from O on AB and BC. Then for each of the angular points on PQRS

$$\left| \frac{1}{2m\omega_1 + 2n\omega_2} \right| \leq \frac{1}{pd};$$

so that

$$\sum \frac{1}{|2m\omega_1 + 2n\omega_2|^3} < \frac{8p}{(pd)^3} = \frac{8}{p^2 d^3},$$

where the summation extends to all the points on PQRS.

Now, if the values 1, 2, 3, . . . , be assigned to p in turn, all the angular points in the plane will be included. Hence

$$\sum_{m=-\infty}^{+\infty} \sum_{n=-\infty}^{+\infty} \frac{1}{|2m\omega_1 + 2n\omega_2|^3} < \frac{8}{d^3} \left(\frac{1}{1^2} + \frac{1}{2^2} + \frac{1}{3^2} + \dots \right) < \frac{16}{d^3},$$

and therefore the series is convergent.

38. Power Series. Let $\sum_{n=0}^{\infty} c_n(z-a)^n$ be a power series, and let the ratio $|c_n/c_{n+1}|$ tend to R as n tends to infinity. Then from the Ratio Test it follows that the series is absolutely convergent within and is divergent without the circle $|z-a|=R$. This circle is called the *Circle of Convergence* and R the *Radius of Convergence*.

Example. Shew that the radius of convergence of the geometric series $1+z+z^2+z^3+\dots$ is unity.

At a point on the circle of convergence the series may or may not be convergent. A test for absolute convergence is given in § 36. The following test is sometimes useful when the series is not absolutely convergent.

Abel's Test. If the coefficients c_1, c_2, c_3, \dots , form a decreasing sequence of positive numbers, c_n tending to zero as n tends to infinity, the sum $\sum_1^{\infty} c_n z^n$ converges at all points of the unit circle except possibly at $z=1$.

For, consider the series

$$c_1 \cos \theta + c_2 \cos 2\theta + c_3 \cos 3\theta + \dots, \quad 0 < \theta < 2\pi.$$

Let
$$S_{m,p} = \sum_{n=1}^{m+p} c_n \cos n\theta,$$

and let $s_r = \cos(m+1)\theta + \cos(m+2)\theta + \dots + \cos(m+r)\theta;$

so that
$$\begin{aligned} \cos(m+1)\theta &= s_1, \\ \cos(m+2)\theta &= s_2 - s_1, \\ &\dots \dots \dots \end{aligned}$$

Then
$$\begin{aligned} S_{m,p} &= c_{m+1}s_1 + c_{m+2}(s_2 - s_1) + \dots + c_{m+p}(s_p - s_{p-1}) \\ &= s_1(c_{m+1} - c_{m+2}) + s_2(c_{m+2} - c_{m+3}) + \dots \\ &\quad + s_{p-1}(c_{m+p-1} - c_{m+p}) + s_p c_{m+p}. \end{aligned}$$

Now
$$s_r = \sin(\frac{1}{2}r\theta) \cos \{m\theta + \frac{1}{2}(r+1)\theta\} / \sin \frac{1}{2}\theta;$$

so that
$$-1/\sin \frac{1}{2}\theta \leq s_r \leq 1/\sin \frac{1}{2}\theta \quad (r=1, 2, 3, \dots).$$

Therefore, since all the quantities

$$c_{m+1} - c_{m+2}, c_{m+2} - c_{m+3}, \dots, c_{m+p},$$

are positive,

$$S_{m,p} \leq \frac{1}{\sin \frac{1}{2}\theta} \{(c_{m+1} - c_{m+2}) + (c_{m+2} - c_{m+3}) + \dots + c_{m+p}\} = \frac{c_{m+1}}{\sin \frac{1}{2}\theta},$$

and

$$S_{m,p} \geq -\frac{c_{m+1}}{\sin \frac{1}{2}\theta}.$$

But, by making m large enough, c_{m+1} can be made arbitrarily small. Therefore, since $0 < \frac{1}{2}\theta < \pi$, the series is convergent.

Similarly, since

$$\sum_{m+1}^{m+r} \sin n\theta = \sin(\frac{1}{2}r\theta) \sin\{m\theta + \frac{1}{2}(r+1)\theta\} / \sin \frac{1}{2}\theta,$$

the series $c_1 \sin \theta + c_2 \sin 2\theta + c_3 \sin 3\theta + \dots$, can be proved convergent if $0 < \theta < 2\pi$. Hence the series

$$\sum_1^{\infty} c_n z^n = \sum_1^{\infty} c_n \cos n\theta + i \sum_1^{\infty} c_n \sin n\theta$$

converges if $0 < \theta < 2\pi$.

This theorem can be illustrated as follows:

If $\text{amp } z \neq n\pi$ (n integral), the terms of the series can be

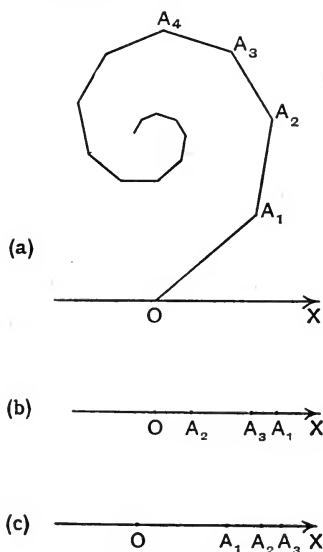

FIG. 43 (a) (b) (c).

represented by $OA_1, A_1A_2, A_2A_3, \dots$, {Fig. 43 (a)}, where each line makes the same angle $\text{amp } z$ with the preceding one. These lines

form a kind of spiral, and A_n tends to a point, which represents the sum of the series. If $\text{amp } z = \pm \pi$ the lines will be alternately positive and negative {Fig. 43(b)} and the series will be convergent; but when $\text{amp } z = 0$ {Fig. 43(c)} the method does not apply.

Example. Shew that $z + z^2/2 + z^3/3 + \dots$ converges for $|z|=1$ except at $z=1$; and deduce that the series

$$\begin{aligned} \cos \theta + \frac{\cos 2\theta}{2} + \frac{\cos 3\theta}{3} + \dots, \\ \sin \theta + \frac{\sin 2\theta}{2} + \frac{\sin 3\theta}{3} + \dots, \end{aligned}$$

are convergent if $\theta \neq 2n\pi$.

Multiplication of Power Series. If the two series

$$\sum_0^{\infty} c_n z^n \quad \text{and} \quad \sum_0^{\infty} c'_n z^n$$

are convergent within the circle $|z|=R$, their product

$$c_0 c'_0 + (c_0 c'_1 + c_1 c'_0)z + (c_0 c'_2 + c_1 c'_1 + c_2 c'_0)z^2 + \dots$$

is also convergent within that circle (cf. § 36).

39. Taylor's Series. Let $f(z)$ be holomorphic in the region bounded by a circle C of centre a and radius R , and let z be any point within C such that $|z-a|=r < R$: then

$$\begin{aligned} f(z) &= \frac{1}{2\pi i} \int_C \frac{f(\xi) d\xi}{\xi - z} = \frac{1}{2\pi i} \int_C \frac{f(\xi) d\xi}{(\xi - a) - (z - a)} \\ &= \frac{1}{2\pi i} \int_C \frac{f(\xi)}{\xi - a} \left\{ 1 + \frac{z-a}{\xi-a} + \left(\frac{z-a}{\xi-a} \right)^2 + \dots \right. \\ &\quad \left. + \left(\frac{z-a}{\xi-a} \right)^n + \frac{(z-a)^{n+1}}{(\xi-a)^n (\xi-z)} \right\} d\xi \\ &= f(a) + \frac{(z-a)}{1!} f'(a) + \frac{(z-a)^2}{2!} f''(a) + \dots \\ &\quad + \frac{(z-a)^n}{n!} f^{(n)}(a) + \frac{(z-a)^{n+1}}{2\pi i} \int_C \frac{f(\xi) d\xi}{(\xi-a)^{n+1} (\xi-z)}. \end{aligned}$$

Now, since $|\xi-z| \geq R-r$ for all points ξ on C , it follows (§ 26, Cor. 7) that

$$\left| \frac{(z-a)^{n+1}}{2\pi i} \int_C \frac{f(\xi) d\xi}{(\xi-a)^{n+1} (\xi-z)} \right| < \frac{M}{1-r/R} \left(\frac{r}{R} \right)^{n+1},$$

where M is the maximum value of $|f(\xi)|$ on C . But this quantity can be made arbitrarily small by increasing n : hence

$$f(z) = f(a) + \frac{z-a}{1!} f'(a) + \frac{(z-a)^2}{2!} f''(a) + \dots$$

for all points within C . This is Cauchy's extension of Taylor's Theorem.*

The convergence is absolute, for (§ 35, Cor. 1) the modulus of each term is not greater than the modulus of the corresponding term of the absolutely convergent series

$$M + M \frac{z-a}{R} + M \left(\frac{z-a}{R} \right)^2 + \dots$$

Let z_1 be the nearest singularity to a : then if z be any point within the circle of centre a and radius $|z_1 - a|$, R can be chosen so that $|z - a| < R < |z_1 - a|$. Thus the Taylor's Series converges absolutely at z , and therefore its radius of convergence is $|z_1 - a|$: that is, the circle of convergence of the Taylor's Series is the domain of the point a .

COROLLARY 1. If $f(z)$ and its first $n-1$ derivatives vanish at a , while $f^{(n)}(a)$ is not zero, a is a zero of $f(z)$ of order n .

For example, $z = k\pi$ is a zero of $\sin z$ (§ 17): this zero is a simple zero since $\cos z$, the derivative of $\sin z$, is not zero at the point.

COROLLARY 2. If $f(z)$ and $\phi(z)$, and also their first $n-1$ derivatives, vanish at a , while $\phi^{(n)}(a) \neq 0$,

$$\lim_{z \rightarrow a} \frac{f(z)}{\phi(z)} = \frac{f^{(n)}(a)}{\phi^{(n)}(a)}.$$

Example. Prove $\lim_{z \rightarrow 0} \frac{\cos 2az - \cos 2bz}{z^2} = 2(b^2 - a^2)$.

COROLLARY 3. If $f^{(n)}(a) = 0$ ($n = 0, 1, 2, \dots$), $f(z)$ vanishes identically at all points in the domain of a .

Example 1. Shew that, for all points within the circle $|z| = 1$,

$$\log(1+z) = z - z^2/2 + z^3/3 - \dots;$$

and deduce that $|\log(1+z)| \leq -\log(1-|z|)$.

Example 2. Prove $\int_0^1 \log(\sin \pi x) dx = -\log 2$.

Integrate $\log(\sin \pi z)$ round the rectangle of sides $x=0, x=1, y=0, y=R$, indented at 0 and 1.

The integrals round the small quadrants at 0 and 1 vanish in the limit;

hence $\int_0^1 \log(\sin \pi x) dx$

$$= i \int_0^R [\log(\sin \pi iy) - \log\{\sin(\pi + \pi iy)\}] dy + \int_0^1 \log\{\sin(\pi x + \pi iR)\} dx.$$

* Cf. § 43, Note.

Now, since $w = \sin \pi z = \sin \pi x \cosh \pi y + i \cos \pi x \sinh \pi y$,
as x increases from 0 to 1, ($y > 0$), w passes round the curve PQR (Fig. 44),

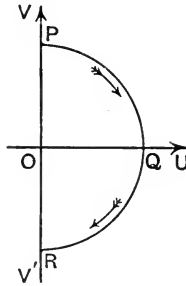

FIG. 44.

from P($i \sinh \pi y$) when $x=0$ to Q($\cosh \pi y$) when $x=1/2$, and to R($-i \sinh \pi y$)
when $x=1$: hence amp $(\sin \pi z)$ decreases by π , so that

$$\log(\sin \pi i y) - \log\{\sin(\pi + \pi i y)\} = \pi i.$$

$$\text{Again } \sin(\pi x + \pi i R) = \frac{i}{2} e^{\pi R - i\pi x} (1 - e^{2\pi x i - 2\pi R}).$$

Therefore

$$\log\{\sin(\pi x + \pi i R)\} = \pi R - \log 2 - i\pi x + i\frac{\pi}{2} + \log(1 - e^{2\pi x i - 2\pi R}).$$

$$\text{Hence } \int_0^1 \log(\sin \pi x) dx = -\log 2 + \int_0^1 \log(1 - e^{2\pi x i - 2\pi R}) dx.$$

$$\text{But } \left| \int_0^1 \log(1 - e^{2\pi x i - 2\pi R}) dx \right| < -\log(1 - e^{-2\pi R}),$$

which tends to zero as R tends to infinity. Therefore

$$\int_0^1 \log(\sin \pi x) dx = -\log 2.$$

Example 3. If $|z| < 1$, prove

$$(i) \quad \tan^{-1} z = z - z^3/3 + z^5/5 - \dots \quad (\text{Gregory's Series});$$

$$(ii) \quad (\tan^{-1} z)^2 = \frac{2z^2}{2} - \left(1 + \frac{1}{3}\right) \frac{2z^4}{4} + \left(1 + \frac{1}{3} + \frac{1}{5}\right) \frac{2z^6}{6} - \dots,$$

where the principal value of $\tan^{-1} z$ is taken in each case.

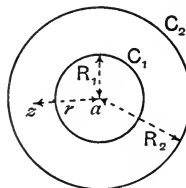

FIG. 45.

40. Laurent's Series. Let $f(z)$ be holomorphic in the ring-space bounded by two concentric circles C_1 and C_2 (Fig. 45) of

centre a and radii R_1 and R_2 , ($R_1 < R_2$). Then if z is any point within the ring-space, so that

$$R_1 < |z - a| = r < R_2,$$

$f(z)$ can be expanded in a series of the form $\sum_{p=-\infty}^{+\infty} A_p(z-a)^p$.

$$\begin{aligned} \text{For } f(z) &= \frac{1}{2\pi i} \int_{C_2} \frac{f(\xi) d\xi}{\xi - z} - \frac{1}{2\pi i} \int_{C_1} \frac{f(\xi) d\xi}{\xi - z} \\ &= \frac{1}{2\pi i} \int_{C_2} \frac{f(\xi) d\xi}{(\xi - a) - (z - a)} + \frac{1}{2\pi i} \int_{C_1} \frac{f(\xi) d\xi}{(z - a) - (\xi - a)} \\ &= \frac{1}{2\pi i} \int_{C_2} \frac{f(\xi)}{\xi - a} \left\{ 1 + \frac{z - a}{\xi - a} + \left(\frac{z - a}{\xi - a} \right)^2 + \dots \right. \\ &\quad \left. + \left(\frac{z - a}{\xi - a} \right)^n + \frac{(z - a)^{n+1}}{(\xi - a)^n (\xi - z)} \right\} d\xi \\ &\quad + \frac{1}{2\pi i} \int_{C_1} \frac{f(\xi)}{z - a} \left\{ 1 + \frac{\xi - a}{z - a} + \left(\frac{\xi - a}{z - a} \right)^2 + \dots \right. \\ &\quad \left. + \left(\frac{\xi - a}{z - a} \right)^n + \frac{(\xi - a)^{n+1}}{(z - a)^n (z - \xi)} \right\} d\xi. \end{aligned}$$

Now let M_1 and M_2 be the maximum values of $|f(z)|$ on C_1 and C_2 ; then (§ 26, Cor. 7), since $|z - a| = r$,

$$\begin{aligned} \left| \frac{(z - a)^{n+1}}{2\pi i} \int_{C_2} \frac{f(\xi) d\xi}{(\xi - a)^{n+1} (\xi - z)} \right| &< \frac{M_2}{1 - r/R_2} \left(\frac{r}{R_2} \right)^{n+1}; \\ \left| \frac{1}{2\pi i (z - a)^{n+1}} \int_{C_1} \frac{f(\xi) (\xi - a)^{n+1} d\xi}{z - \xi} \right| &< \frac{M_1}{r/R_1 - 1} \left(\frac{R_1}{r} \right)^{n+1}. \end{aligned}$$

But these two quantities can each be made as small as we please by increasing n ; hence

$$f(z) = \sum_{p=0}^{\infty} A_p(z-a)^p + \sum_{p=1}^{\infty} A_{-p}(z-a)^{-p},$$

where

$$A_p = \frac{1}{2\pi i} \int_{C_2} \frac{f(\xi) d\xi}{(\xi - a)^{p+1}}, \quad A_{-p} = \frac{1}{2\pi i} \int_{C_1} f(\xi) (\xi - a)^{p-1} d\xi.*$$

Note 1. Since

$$|A_p| \leq M_2/R_2^p \quad \text{and} \quad |A_{-p}| \leq M_1 R_1^p,$$

and $R_1 < |z - a| < R_2$, it follows that the series is absolutely convergent for all points within the ring-space.

* Cf. § 43, p. 95, Note.

Note 2. Since $f(z)$ is holomorphic between C_1 and C_2 , the integrals round these contours can be replaced by integrals round any concentric circle C of radius R , such that $R_1 \leq R \leq R_2$. It

follows that $f(z) = \sum_{p=-\infty}^{+\infty} A_p(z-a)^p$, where

$$A_p = \frac{1}{2\pi i} \int_C f(\xi)(\xi-a)^{-p-1} d\xi.$$

Note 3. Let $\phi(z; a)$ and $\psi(z; a)$ represent the series

$$\sum_0^{\infty} A_p(z-a)^p \quad \text{and} \quad \sum_1^{\infty} A_{-p}(z-a)^{-p} \quad \text{respectively.}$$

Then $f(z) = \phi(z; a) + \psi(z; a)$, where $\phi(z; a)$ is holomorphic within the circle $|z-a| = R_2$, and $\psi(z; a)$ outside the circle $|z-a| = R_1$.

Principal Part at a Pole. If the only singularity within $|z-a| = R_1$ is at a , R_1 can be made arbitrarily small. Then if $\psi(z; a) = \sum_{p=1}^n A_{-p}(z-a)^{-p}$, where n is finite, $f(z)$ has a pole of order n at a , and $\psi(z; a)$ is called the *Principal Part* at the pole. If $\psi(z; a)$ is an infinite series, $f(z)$ has an essential singularity (§ 22) at a .

Example 1. If $f(z)$ is holomorphic in the region bounded by a closed curve C except at the poles a_1, a_2, \dots, a_n , and if $G_r\{1/(z-a_r)\}$ is the principal part of $f(z)$ at a_r ($r=1, 2, \dots, n$), shew that

$$f(\xi) = \sum_1^n G_r\{1/(\xi-a_r)\} + \frac{1}{2\pi i} \int_C \frac{f(z)}{z-\xi} dz,$$

where ξ is any point interior to C . [Cf. **Exs. IV.**, 9.]

Example 2. If $|z| > 1$, and the principal value of $\tan^{-1}z$ is taken, shew that

$$\tan^{-1}z = \pm \frac{\pi}{2} - \left(\frac{1}{z} - \frac{1}{3z^3} + \frac{1}{5z^5} - \dots \right),$$

according as $R(z) \geq 0$.

41. Fourier Series. A uniform function $F(z)$ which satisfies the equation $F(z+\Omega) = F(z)$ for all values of z , where Ω is a non-zero real or complex number, is said to be a *Periodic Function*, and to have the period Ω . It follows that, if m is any integer, positive or negative, $F(z+m\Omega) = F(z)$. If no integer p ($p \neq \pm 1$) can be found such that Ω/p is a period of $F(z)$, Ω is called a *Primitive Period* of the function. A function which has only one *Primitive Period* is said to be *Simply-Periodic*.

Now let the function $f(z)$ have the period 2ω , and let $\xi = e^{i\pi z/\omega}$. To each value of ξ corresponds an infinite number of values of z , differing by multiples of 2ω . Therefore to each value of ξ corresponds one and only one value of $f(z)$, so that $f(z)$ is a uniform function of ξ .

Let A (Fig. 46) be the point 2ω , and let R denote an infinite region of the z -plane, bounded by two lines parallel to OA,

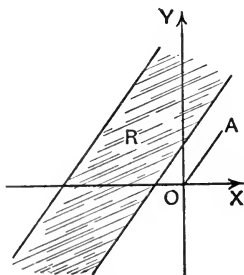

FIG. 46.

in which $f(z)$ is holomorphic. Now if z is any point on a line through z_1 parallel to OA, $z = z_1 + \lambda\omega$, where λ is real, and therefore $\xi = e^{i\pi z_1/\omega} e^{i\pi\lambda}$, so that $|\xi|$ is constant. Hence such a line is represented in the ξ -plane by a circle with the origin as centre, and as z increases by 2ω , ξ passes round the circle once in the positive direction. Any portion of the region R bounded by two straight lines perpendicular to OA, and at a distance OA from each other, is therefore represented on the ξ -plane by a ring-space bounded by concentric circles with the origin as centre.

In this ring-space $f(z)$ is holomorphic since

$$\frac{df(z)}{d\xi} = \frac{df(z)}{dz} \frac{dz}{d\xi} = \frac{\omega}{\pi i \xi} \frac{df(z)}{dz}.$$

Hence, by Laurent's Theorem,

$$f(z) = \sum_{-\infty}^{+\infty} A_p \xi^p = \sum_{-\infty}^{+\infty} A_p e^{p i \pi z / \omega},$$

where
$$A_p = \frac{1}{2\pi i} \int_C f(z) \xi^{-p-1} d\xi = \frac{1}{2\omega} \int_0^{2\omega} f(z) e^{-p i \pi z / \omega} dz,$$

C being any circle in the ring-space with the origin as centre.

Therefore

$$\begin{aligned} f(z) &= A_0 + \sum_1^{\infty} (A_p + A_{-p}) \cos \frac{p\pi z}{\omega} + \sum_1^{\infty} (A_p - A_{-p}) i \sin \frac{p\pi z}{\omega} \\ &= \frac{1}{2} a_0 + \sum_1^{\infty} a_p \cos \frac{p\pi z}{\omega} + \sum_1^{\infty} b_p \sin \frac{p\pi z}{\omega}, \end{aligned}$$

where $a_p = \frac{1}{\omega} \int_0^{2\omega} f(z) \cos \frac{p\pi z}{\omega} dz$, and $b_p = \frac{1}{\omega} \int_0^{2\omega} f(z) \sin \frac{p\pi z}{\omega} dz$.

This is Fourier's well-known expansion: it is valid for all points within the region R. The function $f(z)$, it must be noted, is holomorphic in R.

42. Classification of Uniform Functions. Functions which are holomorphic for all finite values of z are called *Integral Functions*. Such functions are developable by Taylor's Series throughout the plane. From Liouville's Theorem it follows that every integral function which is not a constant must have a singularity at infinity.

THEOREM 1. An Integral Function for which infinity is a pole of order n is a polynomial of degree n .

For, if $f(z)$ be such a function, then by Laurent's Theorem

$$f(1/\xi) = B_1/\xi + B_2/\xi^2 + \dots + B_n/\xi^n + \phi(\xi),$$

where $\phi(\xi)$ is holomorphic at $\xi=0$. Hence

$$f(z) = B_1 z + B_2 z^2 + \dots + B_n z^n + \phi(1/z).$$

Therefore $\phi(1/z) = f(z) - (B_1 z + B_2 z^2 + \dots + B_n z^n)$.

Accordingly $\phi(1/z)$ is holomorphic for all finite values of z . Hence, since $\phi(1/z)$ is holomorphic at infinity, it must, by Liouville's Theorem, be a constant, B_0 say.

Therefore $f(z) = B_0 + B_1 z + B_2 z^2 + \dots + B_n z^n$.

Polynomials are also known as *Rational Integral Functions*.

An integral function which is not a polynomial is called a *Transcendental Integral Function*. The Taylor's Series contains an infinite number of terms, and thus the function has an essential singularity at infinity. Examples of such functions are e^z , $\cos z$, and $\sin z$.

An integral function $f(z)$ which has no zeros in the finite part of the plane can be put in the form $e^{G(z)}$, where $G(z)$ is integral. For the function $G(z) \equiv \log \{f(z)\}$ has no singularities in the

finite part of the plane, and is therefore an integral function: hence $f(z) = e^{G(z)}$. For example, e^z has no zeros except at infinity.

The ratio of two polynomials is called a *Rational Function*.

THEOREM 2. If $f(z)$ is meromorphic throughout the plane, and if infinity is either an ordinary point or a pole, $f(z)$ is a Rational Function.

Let there be m poles a_1, a_2, \dots, a_m , in the finite part of the plane (§ 22, Th. 2, Cor.), and let the principal part of $f(z)$ at a_r be

$$\phi_r(z) = A_1^{(r)}/(z - a_r) + A_2^{(r)}/(z - a_r)^2 + \dots + A_{p_r}^{(r)}/(z - a_r)^{p_r},$$

($r = 1, 2, \dots, m$).

Then $f(z) - \sum_1^m \phi_r(z)$ is finite at all finite points of the plane.

Accordingly, since $\phi_1(z), \phi_2(z), \dots, \phi_m(z)$, are all zero at infinity,

$f(z) - \sum_1^m \phi_r(z)$ must be a constant or a polynomial, say

$$\psi(z) = c_0 + c_1z + \dots + c_qz^q.$$

Hence $f(z) = \sum_1^m \phi_r(z) + \psi(z)$, which is a Rational Function.

COROLLARY. A meromorphic function other than a Rational Function must have an essential singularity at infinity.

EXAMPLES V.

1. Shew that the series:

$$(i) \quad 1 + \frac{z}{1!} + \frac{z^2}{2!} + \frac{z^3}{3!} + \dots;$$

$$(ii) \quad 1 - \frac{z^2}{2!} + \frac{z^4}{4!} - \dots;$$

$$(iii) \quad z - \frac{z^3}{3!} + \frac{z^5}{5!} - \dots;$$

are absolutely convergent for all values of z .

2. Shew that the series $\sum_0^{\infty} c_n z^n$ and the series of derivatives $\sum_1^{\infty} n c_n z^{n-1}$ have the same radius of convergence.

3. Shew that the radius of convergence of the series $\sum_0^{\infty} n! z^n$ is zero. [Such series do not define functions.]

4. Shew that the product of the series $\sum_0^{\infty} z^n/n!$ and $\sum_0^{\infty} z'^n/n!$ is $\sum_0^{\infty} (z+z')^n/n!$.

5. Shew that the series $\sum_1^{\infty} \frac{z^{n+1}}{n(n+1)}$ is absolutely convergent at all points on its circle of convergence.

6. Shew that, for all finite values of z :

$$(i) \exp(z) = 1 + \frac{z}{1!} + \frac{z^2}{2!} + \frac{z^3}{3!} + \dots;$$

$$(ii) \cos z = 1 - \frac{z^2}{2!} + \frac{z^4}{4!} - \dots;$$

$$(iii) \sin z = z - \frac{z^3}{3!} + \frac{z^5}{5!} - \dots;$$

$$(iv) \cosh z = 1 + \frac{z^2}{2!} + \frac{z^4}{4!} + \dots$$

7. Shew that, for all values of n , the Binomial Theorem,

$$(1+z)^n = 1 + nz + \frac{n(n-1)}{2!} z^2 + \frac{n(n-1)(n-2)}{3!} z^3 + \dots,$$

holds for all points within the circle $|z|=1$, that branch of $(1+z)^n$ being taken which has the value unity when $z=0$.

8. If the function $f(z)$ has an essential singularity at a , shew that $1/f(z)$ has also an essential singularity at a .

9. Shew that the series

$$1 + \frac{z}{1+z} + \left(\frac{z}{1+z}\right)^2 + \dots$$

is convergent if $R(z) > -1/2$, and find its sum.

Ans. $1+z$.

10. Prove that, if $|z| < 1$,

$$\frac{1}{1+z+z^2} = \frac{2}{\sqrt{3}} \left(\sin \frac{2\pi}{3} + z \sin \frac{4\pi}{3} + z^2 \sin \frac{6\pi}{3} + \dots \right).$$

11. Prove

$$(i) \lim_{z \rightarrow 0} \frac{1 - \cos z}{z^2} = \frac{1}{2}; \quad (ii) \lim_{z \rightarrow 0} \frac{z - \sin z}{z^3} = \frac{1}{6}; \quad (iii) \lim_{z \rightarrow 0} \frac{z \cos z - \sin z}{z^2 \sin z} = -\frac{1}{3}.$$

12. Prove that, if $R(z) > -1$,

$$\frac{1}{(z+1)^2} = \frac{1}{(z+1)(z+2)} + \frac{1!}{(z+1)(z+2)(z+3)} + \frac{2!}{(z+1)(z+2)(z+3)(z+4)} + \dots$$

13. Prove that, if $|z| < 1$,

$$\frac{1}{2} \{ \log(1+z) \}^2 = \frac{1}{2} z^2 - \frac{1}{3} \left(1 + \frac{1}{2}\right) z^3 + \frac{1}{4} \left(1 + \frac{1}{2} + \frac{1}{3}\right) z^4 - \dots$$

14. Shew that the series

$$\frac{z}{1+z} + \frac{2z^2}{1+z^2} + \frac{4z^4}{1+z^4} + \frac{8z^8}{1+z^8} + \dots,$$

converges if $|z| < 1$, and that its sum is $z/(1-z)$.

15. Shew that the series

$$\frac{z}{1-z^2} + \frac{z^2}{1-z^4} + \frac{z^4}{1-z^8} + \frac{z^8}{1-z^{16}} + \dots,$$

is convergent if $|z| < 1$ and also if $|z| > 1$, and that the respective sums are $z/(1-z)$ and $1/(1-z)$.

16. Shew that the series $\sum_{-\infty}^{+\infty} q^{n^2} e^{2\pi i n z}$ converges for all finite values of z if $|q| < 1$.

17. Shew that, with the notation of § 37, the series

$$\sum_{m=-\infty}^{+\infty} \sum_{n=-\infty}^{+\infty} \frac{1}{(2m\omega_1 + 2n\omega_2)^\lambda}$$

is absolutely convergent if $\lambda > 2$.

18. Shew that the series

$$1 + \frac{z}{1!} + \frac{2m+2}{2!} z^2 + \dots + \frac{(nm+2)(nm+3)\dots(nm+n)}{n!} z^n + \dots,$$

where m is a positive integer, is absolutely convergent if $|z| < m^n/(m+1)^{n+1}$.

19. Shew that the radius of convergence of the series

$$1 + az + \frac{a(a-2b)}{2!} z^2 + \frac{a(a-3b)^2}{3!} z^3 + \dots$$

is $e^{-1}/|b|$.

20. Shew that the series

$$1 - kz + \frac{k(k-3)}{2!} z^2 - \frac{k(k-4)(k-5)}{3!} z^3 + \dots$$

is convergent if $|z| < 1/4$.

21. If $a > 0$, shew that

$$\int_0^\infty \frac{x - \sin x}{x^3(a^2 + x^2)} dx = \frac{\pi}{2a^4} (a^2/2 - a + 1 - e^{-a}).$$

[Integrate $(e^{iz} - 1 - iz + z^2/2)/\{z^3(a^2 + z^2)\}$ round the contour of Fig. 33.]

22. Prove

$$\int_0^\infty \frac{\cos x^2 + \sin x^2 - 1}{x^2} dx = 0.$$

[Integrate $(e^{iz^2} - 1)/z^2$ round the contour consisting of the positive x and y axes and a quadrant of an infinite circle.]

23. If a and b are positive, prove

$$\int_0^\infty \frac{\cos 2ax - \cos 2bx}{x^2} dx = \pi(b - a).$$

24. Shew that, if a and m are positive,

$$\int_0^\infty \frac{\sin^2 mx}{x^2(a^2 + x^2)} dx = \frac{\pi}{4a^3} (e^{-2ma} - 1 + 2ma).$$

CHAPTER VI.

UNIFORMLY CONVERGENT SERIES: INFINITE PRODUCTS.

43. Uniformly Convergent Series. Let $S_n(z)$ denote the sum of the first n terms of the infinite series $\sum_{n=1}^{\infty} w_n(z)$, whose terms are functions of z ; then if, at all points of a region A , the sequence $S_1(z), S_2(z), S_3(z), \dots$, converges uniformly (§23), the series is said to be *Uniformly Convergent* in A . The necessary and sufficient condition for this is that, corresponding to any ϵ ,* an m can be found such that, for all points of A ,

$$|w_{n+1}(z) + w_{n+2}(z) + \dots + w_{n+p}(z)| < \epsilon,$$

where $p=1, 2, 3, \dots$, and $n \geq m$. The region A is a *closed* region; *i.e.*, the points on the boundary are included.

Example. If the series $\sum_{n=1}^{\infty} w_n(z)$ converges uniformly in a region A , and if $f(z)$ is finite in A , shew that the series $\sum_{n=1}^{\infty} f(z)w_n(z)$ converges uniformly in A .

In the following three theorems it is assumed that the series $\sum_{n=1}^{\infty} w_n(z)$ is uniformly convergent in the region A .

THEOREM I. If $w_1(z), w_2(z), w_3(z), \dots$, are continuous in A , the function $S(z) = \sum_{n=1}^{\infty} w_n(z)$ is also continuous in A .

For, if z and $z + \Delta z$ are points of A , an m can be found such that

$$|S(z) - S_n(z)| < \frac{\epsilon}{3}, \quad |S(z + \Delta z) - S_n(z + \Delta z)| < \frac{\epsilon}{3},$$

where $n \geq m$. But, since $S_n(z)$ is continuous, an η can be found such that, for $|\Delta z| < \eta$,

$$|S_n(z + \Delta z) - S_n(z)| < \frac{\epsilon}{3}.$$

* It should be noted that ϵ is independent of z .

Hence, if $|\Delta z| < \eta$,

$$\begin{aligned} |\underline{S(z+\Delta z)} - S(z)| &= |\{S(z+\Delta z) - S_n(z+\Delta z)\} - \{S(z) - S_n(z)\} \\ &\quad + \{S_n(z+\Delta z) - S_n(z)\}| \\ &\leq |S(z+\Delta z) - S_n(z+\Delta z)| + |S(z) - S_n(z)| \\ &\quad + |S_n(z+\Delta z) - S_n(z)| \\ &< \epsilon. \end{aligned}$$

Therefore $S(z)$ is continuous in A .

THEOREM 2. The series $\sum_{n=1}^{\infty} \int_C w_n(z) dz$, where C is a path in the region A , is convergent and has the sum $\int_C S(z) dz$.

For, since at all points of A

$$|S(z) - S_n(z)| < \epsilon, \quad (n \geq m),$$

$$\left| \int_C S(z) dz - \sum_1^n \int_C w_n(z) dz \right| = \left| \int_C \{S(z) - S_n(z)\} dz \right| < \epsilon l,$$

where l is the length of C .

COROLLARY. If the initial and final points of C are z_0 and z ,

$$\int_{z_0}^z S(z) dz, \quad \int_{z_0}^z w_1(z) dz, \quad \int_{z_0}^z w_2(z) dz, \quad \dots,$$

are functions of z , and $\sum_{n=1}^{\infty} \int_{z_0}^z w_n(z) dz$ converges uniformly in A , since a maximum value can be assigned to l . Accordingly, if a uniformly convergent series be integrated term by term, the resultant series is also uniformly convergent.

THEOREM 3. If $w_1(z)$, $w_2(z)$, $w_3(z)$, ..., are holomorphic in A , $S(z)$ is holomorphic at all interior points of A , and

$$\frac{d^k S(z)}{dz^k} = \sum_1^{\infty} \frac{d^k w_n(z)}{dz^k}, \quad (k=1, 2, 3, \dots).$$

Let ξ be any interior point of A , and let C be the boundary of a simply-connected portion of A of which ξ is an interior point.

Then if, for all points of C , $\left| \sum_{n=1}^{n+p} w_n(z) \right| < \epsilon$,

$$\left| \sum_{n=1}^{n+p} w_n(z) (z - \xi)^{-k-1} \right| = \left| \sum_{n=1}^{n+p} w_n(z) \right| |z - \xi|^{-k-1} < \epsilon d^{-k-1},$$

where d is the shortest distance from ξ to C , and $k+1 > 0$. Thus

$\sum_1^{\infty} \int_C w_n(z)(z-\xi)^{-k-1} dz$ converges to the sum $\int_C S(z)(z-\xi)^{-k-1} dz$, and therefore, since

$$\int_C \frac{w_n(z)}{(z-\xi)^{k+1}} dz = \frac{2\pi i}{k!} \frac{d^k w_n(\xi)}{d\xi^k}, \quad (k=0, 1, 2, \dots),$$

$$\sum_{n=1}^{\infty} \frac{d^k w_n(\xi)}{d\xi^k} = \frac{k!}{2\pi i} \int_C \frac{S(z) dz}{(z-\xi)^{k+1}}, \quad (\text{Theorem 2}).$$

In particular, if $k=0$,

$$S(\xi) = \frac{1}{2\pi i} \int_C \frac{S(z) dz}{z-\xi}.$$

Now, this integral is holomorphic (§35, Corollary 2) at ξ . Accordingly $S(\xi)$ is holomorphic at ξ , and has derivatives given by

$$\frac{d^k S(\xi)}{d\xi^k} = \frac{k!}{2\pi i} \int_C \frac{S(z) dz}{(z-\xi)^{k+1}} = \sum_{n=1}^{\infty} \frac{d^k w_n(\xi)}{d\xi^k}, \quad (k=1, 2, 3, \dots).$$

COROLLARY. If C (Fig. 47) is the boundary of a simply-connected portion of A , and if C' is the boundary of a region A' interior to C , the series of functions of ξ ,

$$\sum_1^{\infty} \int_C w_n(z)(z-\xi)^{-k-1} dz,$$

will be uniformly convergent in A' , provided $d > 0$, where d is the shortest distance between C' and C .

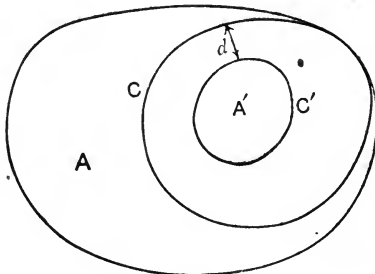

FIG. 47.

Example. If the terms of the series $S(z) = \sum_1^{\infty} w_n(z)$ are holomorphic in the region contained by a closed contour C , and if the series converges uniformly on C , prove that $S(z)$ is holomorphic within C .

Weierstrass's M Test. The series $\sum_1^{\infty} w_n(z)$ will be absolutely and uniformly convergent in the region A , provided that a con-

vergent series of positive constants $\sum_1^\infty M_n$ can be found such that, for all points z in A , $|w_n(z)| \leq M_n$, ($n = 1, 2, 3, \dots$).

For, if $M_{n+1} + M_{n+2} + \dots + M_{n+p} < \epsilon$,

$$|w_{n+1} + w_{n+2} + \dots + w_{n+p}| \leq |w_{n+1}| + |w_{n+2}| + \dots + |w_{n+p}| < \epsilon.$$

Note. Since the moduli of the terms of the series

$$\sum_0^\infty \left(\frac{z-a}{\xi-a}\right)^n, \quad \sum_0^\infty \left(\frac{\xi-a}{z-a}\right)^n,$$

employed in the proof of Laurent's Theorem (§ 40), are less than the corresponding terms of the series $\sum_0^\infty (r/R_2)^n$ and $\sum_0^\infty (R_1/r)^n$, the series integrated are uniformly convergent on the paths of integration. Thus the consideration of the remainder can be omitted from the proof, provided that the M Test has been previously proved. The proof of Taylor's Theorem (§ 39) can then be contracted in a similar manner.

Example 1. Shew that the circle of convergence of the series $\sum_1^\infty z^n/n^2$ is a region of uniform convergence.

Example 2. Shew that the series $\sum_1^\infty 1/(z^2 - n^2\pi^2)$ represents a meromorphic function with poles at the points $\pm\pi, \pm 2\pi, \pm 3\pi, \dots$.

Let z be any point of the region bounded by $|z| = R$, where

$$m\pi < R < (m+1)\pi.$$

Then $|z \pm n\pi| \geq n\pi - R$, where $n = m+1, m+2, \dots$; and therefore

$$\left| \frac{1}{z^2 - n^2\pi^2} \right| \leq \frac{1}{(n\pi - R)^2}, \quad (n = m+1, m+2, \dots).$$

Accordingly, since the series $\sum_1^\infty 1/(n\pi - R)^2$ is convergent, $\sum_{m+1}^\infty 1/(z^2 - n^2\pi^2)$ converges uniformly at all points of the region.

Now the function $\sum_1^m 1/(z^2 - n^2\pi^2)$ is holomorphic at all points of the region except the poles $\pm\pi, \pm 2\pi, \dots, \pm m\pi$. Hence the given series is holomorphic in the circle except at these points. But R can be chosen so large that any assigned point lies in the circle; therefore the series is holomorphic at all points except $\pm\pi, \pm 2\pi, \pm 3\pi, \dots$.

44. Power Series. Let R be the radius of convergence of the power series $\sum_1^\infty c_n(z-a)^n$. Then if $R_1 < R$, the area of the circle $|z-a| = R_1$ is a region of uniform convergence.

For, corresponding to any ϵ , an m can be found such that if $n \geq m$,

$$|c_{n+1}| R_1^{n+1} + |c_{n+2}| R_1^{n+2} + \dots + |c_{n+p}| R_1^{n+p} < \epsilon \quad (p = 1, 2, 3, \dots).$$

Therefore, if $|z-a| \leq R_1$,

$$\begin{aligned} & |c_{n+1}(z-a)^{n+1} + c_{n+2}(z-a)^{n+2} + \dots + c_{n+p}(z-a)^{n+p}| \\ & \leq |c_{n+1}(z-a)^{n+1}| + |c_{n+2}(z-a)^{n+2}| + \dots + |c_{n+p}(z-a)^{n+p}| \\ & \leq |c_{n+1}|R_1^{n+1} + |c_{n+2}|R_1^{n+2} + \dots + |c_{n+p}|R_1^{n+p} \\ & < \epsilon. \end{aligned}$$

Since any point ξ within the circle of convergence can be enclosed in a region of uniform convergence bounded by $|z-a| = R_1$, where $|\xi-a| < R_1 < R$, it follows that the series gives a holomorphic function at all interior points of the circle of convergence.

COROLLARY 1: If the series $\sum_{-\infty}^{+\infty} c_n(z-a)^n$ converges for $R_1 < |z-a| < R_2$, it will be uniformly convergent for

$$R_1 < R_1' \leq |z-a| \leq R_2' < R_2.$$

Example. If $f(z)$ is defined by the series $\sum_{-\infty}^{\infty} c_n(z-a)^n$, convergent for $0 < |z-a| < R$, shew that the residue of $f(z)$ at a is c_{-1} .

COROLLARY 2. If $f(z)$ is holomorphic and has the Laurent Expansion $\sum_{-\infty}^{\infty} A_p z^p$ in the region $R_1 \leq |z| \leq R_2$, and if infinity is the only singularity exterior to $|z| = R_2$, the residue of $f(z)$ at infinity is $-A_{-1}$.

Example 1. Prove that the residues of $e^{1/z}$ at the origin and at infinity are $+1$ and -1 respectively.

Example 2. If n is integral and ≥ 1 , prove that the residue at infinity of that branch of $\frac{z^{2n}}{(1+z^2)\sqrt{(z^2-1)}}$ which is positive when z is real and > 1 is

$$-\left\{ \frac{1 \cdot 3 \cdot 5 \dots (2n-3)}{2 \cdot 4 \cdot 6 \dots (2n-2)} - \frac{1 \cdot 3 \cdot 5 \dots (2n-5)}{2 \cdot 4 \cdot 6 \dots (2n-4)} + \dots + (-1)^{n-1} \right\}.$$

Undetermined Coefficients. Let $f(z)$ and $\phi(z)$ denote the series

$$\sum_{-\infty}^{\infty} A_n(z-a)^n, \quad \sum_{-\infty}^{\infty} c_n(z-a)^n,$$

which converge in the region $R_1 < |z-a| < R_2$, and let the coefficients c_n , ($n=0, \pm 1, \pm 2, \dots$) be unknown. Then if $\phi(z) = f(z)$ for all points of this region,

$$c_n = A_n, \quad (n=0, \pm 1, \pm 2, \dots).$$

For, if C is the circle $|z - a| = R$ ($R_1 < R < R_2$),

$$c_n = \frac{1}{2\pi i} \int_C \frac{\phi(\xi) d\xi}{(\xi - a)^{n+1}} = \frac{1}{2\pi i} \int_C \frac{f(\xi) d\xi}{(\xi - a)^{n+1}} = A_n.$$

In particular, if $f(z) = 0$ for all points in the region,

$$c_n = 0 \quad (n = 0, \pm 1, \pm 2, \dots).$$

COROLLARY. If $f(z)$ is odd, all the coefficients of even powers of z in the Laurent Series $f(z) = \sum_{-\infty}^{\infty} c_n z^n$ are zero; while if $f(z)$ is even, all the coefficients of odd powers of z are zero.

For, if $f(z)$ is odd,

$$f(z) + f(-z) = 0 = 2 \sum_{-\infty}^{\infty} c_{2n} z^{2n};$$

while, if $f(z)$ is even,

$$f(z) - f(-z) = 0 = 2 \sum_{-\infty}^{\infty} c_{2n+1} z^{2n+1}.$$

Example. Consider the function $1/(e^z - 1)$: it has simple poles of residue $+1$ at the points $0, \pm 2\pi i, \pm 4\pi i, \dots$. Hence, if $0 < |z| < 2\pi$,

$$\frac{1}{e^z - 1} = \frac{1}{z} + c_0 + c_1 z + c_2 z^2 + \dots, \dots\dots\dots(1)$$

where the coefficients c_0, c_1, c_2, \dots , are to be determined.

If the sign of z be changed,

$$\frac{1}{e^{-z} - 1} = -\frac{1}{z} + c_0 - c_1 z + c_2 z^2 - \dots$$

Adding these two equations, we have

$$-1 = 2c_0 + 2c_2 z^2 + 2c_4 z^4 + \dots;$$

so that

$$c_0 = -1/2, \quad c_2 = c_4 = c_6 = \dots = 0.$$

Next, multiply both sides of equation (1) by $e^z - 1$: then

$$\begin{aligned} 1 &= \left(\frac{1}{z} - \frac{1}{2} + c_1 z + c_3 z^3 + c_5 z^5 + \dots \right) (e^z - 1) \\ &= \left(\frac{1}{z} - \frac{1}{2} + c_1 z + c_3 z^3 + c_5 z^5 + \dots \right) \left(z + \frac{z^2}{2!} + \frac{z^3}{3!} + \dots \right). \end{aligned}$$

Hence, equating coefficients, we obtain the equations

$$\begin{aligned} c_1 - \frac{1}{2 \cdot 2!} + \frac{1}{3!} &= 0, \\ c_3 + \frac{c_1}{3!} - \frac{1}{2 \cdot 4!} + \frac{1}{5!} &= 0, \\ \dots\dots\dots \end{aligned}$$

from which the coefficients c_1, c_3, c_5, \dots , can be found.

45. Additional Contour Integrals. The calculation of residues by means of expansions in series is found helpful in the evaluation of many definite integrals.

Example 1. Prove $\int_0^\infty \frac{\sin mx \, dx}{x(x^2+a^2)^2} = \frac{\pi}{2a^4} - \frac{\pi e^{-ma}(m+2/a)}{4a^3}$,

where m and a are real and positive.

Integrate $\frac{e^{mzi}}{z(z^2+a^2)^2}$ over the contour of Fig. 37 (§ 30). When R tends to infinity, the integral along the large semi-circle tends to zero. When r tends to zero, the integral along the small semi-circle tends to $-i\pi/a^4$.

To calculate the residue of the integrand at ia put $z=ia+\zeta$: then

$$\begin{aligned} \frac{e^{mzi}}{z(z^2+a^2)^2} &= \frac{e^{-ma+im\zeta}}{(ia+\zeta)(2ia+\zeta)^2\zeta^2} \\ &= \frac{e^{-ma}}{-4ia^3\zeta^2} (1+im\zeta+\dots)(1+i\zeta/a+\dots)(1+i\zeta/a+\dots) \\ &= \frac{e^{-ma}}{-4ia^3\zeta^2} \{1+i\zeta(m+2/a)+\dots\}. \end{aligned}$$

Hence the residue at $\zeta=0$ is $-e^{-ma}(m+2/a)/(4a^3)$;

and therefore $\int_0^\infty \frac{2i \sin mx}{x(x^2+a^2)^2} dx - \frac{i\pi}{a^4} = -2\pi i \frac{e^{-ma}(m+2/a)}{4a^3}$;

from which the required result follows.

Example 2. Evaluate $\int_0^1 \frac{x^{2n} dx}{(1+x^2)\sqrt{1-x^2}}$, where n is a positive integer.

Consider that branch of $\frac{z^{2n}}{(1+z^2)\sqrt{z^2-1}}$ which is real and positive when z is real and > 1 .

This function is uniform in the region between the great circle C (Fig. 48)

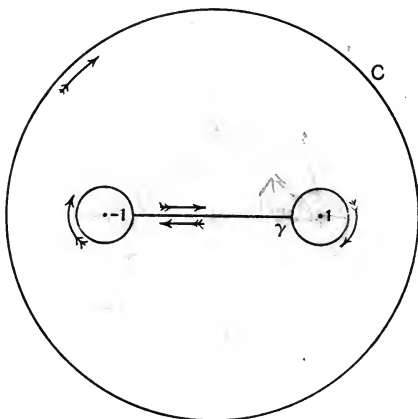

FIG. 48.

and the closed contour γ consisting of small circles about -1 and 1 , and the real axis between these circles. There are simple poles at $+i$ and $-i$.

At $z=i$, $\text{amp}(z-1)=3\pi/4$ and $\text{amp}(z+1)=\pi/4$: therefore

$$\sqrt{z^2-1} = \sqrt{2} e^{i\pi/2} = \sqrt{2}i.$$

Hence the residue at $z=i$ is $(-1)^{n-1}/(2\sqrt{2})$. Similarly the residue at $z=-i$ is $(-1)^{n-1}/(2\sqrt{2})$. Thus

$$\int_C \frac{z^{2n} dz}{(1+z^2)\sqrt{z^2-1}} = \int_\gamma \frac{z^{2n} dz}{(1+z^2)\sqrt{z^2-1}} - 2\pi i (-1)^{n-1}/\sqrt{2},$$

where the integrals along C and γ are taken in the directions indicated by the arrows.

But (§ 44, Corollary 2, Example 2)

$$\int_C \frac{z^{2n} dz}{(1+z^2)\sqrt{z^2-1}} = -2\pi i \left\{ \frac{1 \cdot 3 \cdot 5 \dots (2n-3)}{2 \cdot 4 \cdot 6 \dots (2n-2)} - \frac{1 \cdot 3 \cdot 5 \dots (2n-5)}{2 \cdot 4 \cdot 6 \dots (2n-4)} + \dots + (-1)^{n-1} \right\},$$

and

$$\begin{aligned} \int_\gamma \frac{z^{2n} dz}{(1+z^2)\sqrt{z^2-1}} &= \frac{1}{e^{i\pi/2}} \int_{-1}^1 \frac{x^{2n} dx}{(1+x^2)\sqrt{1-x^2}} - \frac{1}{e^{-i\pi/2}} \int_{-1}^1 \frac{x^{2n} dx}{(1+x^2)\sqrt{1-x^2}} \\ &= -2i \int_{-1}^1 \frac{x^{2n} dx}{(1+x^2)\sqrt{1-x^2}} = -4i \int_0^1 \frac{x^{2n} dx}{(1+x^2)\sqrt{1-x^2}}. \end{aligned}$$

Therefore

$$\begin{aligned} \int_0^1 \frac{x^{2n} dx}{(1+x^2)\sqrt{1-x^2}} &= \frac{\pi}{2} \left\{ \frac{(-1)^n}{\sqrt{2}} + \frac{1 \cdot 3 \cdot 5 \dots (2n-3)}{2 \cdot 4 \cdot 6 \dots (2n-2)} \right. \\ &\quad \left. - \frac{1 \cdot 3 \cdot 5 \dots (2n-5)}{2 \cdot 4 \cdot 6 \dots (2n-4)} + \dots + (-1)^{n-1} \right\}. \end{aligned}$$

Example 3. Prove $\int_{-1}^1 \frac{dx}{\sqrt[3]{(1+x)^2(1-x)}} = \frac{2\pi}{\sqrt{3}}$. *Wolstenholme's*
Pole at $z=\infty$

46. Legendre Polynomials. Consider that branch of

$$(1 - 2\xi z + z^2)^{-1/2}$$

in the domain of $z=0$ which has the value $+1$ when $z=0$. Since the function has singularities at $\xi \pm \sqrt{(\xi^2-1)}$, it can (§ 39), for values of z such that $|z|$ is less than the smaller of the two quantities $|\xi \pm \sqrt{\xi^2-1}|$, be expanded in a series

$$P_0(\xi) + zP_1(\xi) + z^2P_2(\xi) + \dots,$$

in which the coefficients are polynomials in ξ . The coefficient $P_n(\xi)$ is called *Legendre's Polynomial of order n* .

Example. Shew that

$$P_0(z)=1, \quad P_1(z)=z, \quad P_2(z)=\frac{1}{2}(3z^2-1).$$

If we expand both sides of the equation

$$\{1 - 2(-\xi)z + z^2\}^{-1/2} = \{1 - 2\xi(-z) + (-z)^2\}^{-1/2}$$

and equate the corresponding coefficients, we obtain

$$P_n(-\xi) = (-1)^n P_n(\xi).$$

Again, from the expansion for $(1 - 2\zeta z + z^2)^{-\frac{1}{2}}$, it follows that

$$P_n(\zeta) = \frac{1}{2\pi i} \int_c \frac{dz}{z^{n+1} \sqrt{(1 - 2\zeta z + z^2)}}$$

where c is a small circle about the origin.

Now c can be replaced by the contour of Fig. 49, described in the direction indicated by the arrows, where A and B are the

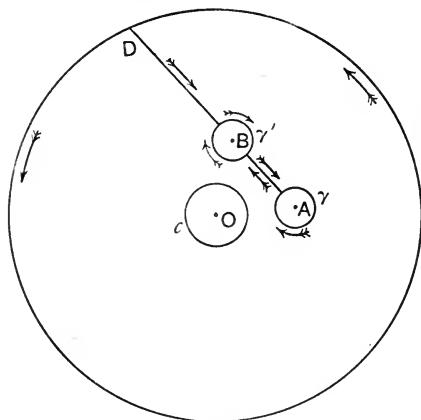

FIG. 49.

points $\zeta \pm \sqrt{\zeta^2 - 1}$, C is a large circle, and γ and γ' are small circles about A and B.

The only case in which this cannot be done is when AB passes through O. But in order that this may be so,

$$(\zeta + \sqrt{\zeta^2 - 1}) / (\zeta - \sqrt{\zeta^2 - 1})$$

must be real and negative. Therefore, since

$$(\zeta + \sqrt{\zeta^2 - 1}) / (\zeta - \sqrt{\zeta^2 - 1}) = (\zeta + \sqrt{\zeta^2 - 1})^2 = (\zeta - \sqrt{\zeta^2 - 1})^{-2},$$

the two quantities $\zeta + \sqrt{\zeta^2 - 1}$ and $\zeta - \sqrt{\zeta^2 - 1}$ must be purely imaginary.

Hence, by addition, it follows that ζ is either zero or purely imaginary. We therefore exclude the case in which ζ lies on the imaginary axis.

The integrals along the circles C, γ , and γ' vanish in the limit, while the integrals along DB and BD cancel each other; thus

$$\begin{aligned} P_n(\zeta) &= \pm \frac{1}{\pi i} \int_{AB} \frac{dz}{z^{n+1} \sqrt{(1 - 2\zeta z + z^2)}} \\ &= \pm \frac{1}{\pi i} \int_0^\pi \frac{-\sqrt{\zeta^2 - 1} \sin \phi d\phi}{(\zeta + \sqrt{\zeta^2 - 1} \cos \phi)^{n+1} (\pm \sqrt{1 - \zeta^2} \sin \phi)}, \end{aligned}$$

where $z = \xi + \sqrt{\xi^2 - 1} \cos \phi$

$$= \pm \frac{1}{\pi} \int_0^\pi \frac{d\phi}{(\xi + \sqrt{\xi^2 - 1} \cos \phi)^{n+1}}.$$

The branch of $\sqrt{\xi^2 - 1}$ considered does not matter, since $\cos(\pi - \phi) = -\cos \phi$.

The integrand has a singularity if $\xi/\sqrt{\xi^2 - 1}$ is real and numerically less than 1. In that case $\xi^2/(\xi^2 - 1)$ must be real and less than 1, and therefore ξ^2 is negative. Hence ξ is purely imaginary. The imaginary axis is therefore a line of singularities for the integral.

If $\xi = 1$, $P_n(\xi) = 1$, so that the + sign must be taken: if $\xi = -1$, $P_n(\xi) = (-1)^n$, and therefore the - sign must be taken. Hence, for points to the right of the imaginary axis,

$$P_n(\xi) = \frac{1}{\pi} \int_0^\pi \frac{d\phi}{(\xi + \sqrt{\xi^2 - 1} \cos \phi)^{n+1}},$$

while, for points to the left of the imaginary axis,

$$P_n(\xi) = -\frac{1}{\pi} \int_0^\pi \frac{d\phi}{(\xi + \sqrt{\xi^2 - 1} \cos \phi)^{n+1}}.$$

Again, in the equation

$$P_n(\xi) = \frac{1}{2\pi i} \int_c \frac{dz}{z^{n+1} \sqrt{(1 - 2\xi z + z^2)}},$$

put $1/z$ for z : then

$$P_n(\xi) = \frac{1}{2\pi i} \int_c \frac{z^n dz}{\sqrt{(1 - 2\xi z + z^2)}} = \pm \frac{1}{\pi i} \int_{AB} \frac{z^n dz}{\sqrt{(1 - 2\xi z + z^2)}},$$

since the integrand is holomorphic between C and the contour made up of γ , γ' , and AB described twice.

Thus
$$P_n(\xi) = \pm \frac{1}{\pi} \int_0^\pi (\xi + \sqrt{\xi^2 - 1} \cos \phi)^n d\phi.$$

Since $P_n(1) = 1$, we take the + sign: thus

$$P_n(\xi) = \frac{1}{\pi} \int_0^\pi (\xi + \sqrt{\xi^2 - 1} \cos \phi)^n d\phi.$$

Again, let $\xi = \cos \theta$, ($0 < \theta < \pi$), so that A and B become the points (Fig. 50) $e^{i\theta}$ and $e^{-i\theta}$. Then if, in replacing the path c

by the contour of Fig. 49, the arc AB of the unit circle is taken instead of the straight line AB, we obtain

$$P_n(\cos \theta) = -\frac{1}{\pi i} \int_{AB} \frac{dz}{z^{n+1} \sqrt{(1-2z \cos \theta + z^2)}}.$$

Thus, if $z = e^{i\phi}$,

$$\begin{aligned} P_n(\cos \theta) &= \frac{1}{\pi} \int_{-\theta}^{\theta} \frac{e^{-(n+\frac{1}{2})i\phi} d\phi}{\sqrt{(2 \cos \phi - 2 \cos \theta)}} \\ &= \frac{2}{\pi} \int_0^{\theta} \frac{\cos(n + \frac{1}{2})\phi d\phi}{\sqrt{(2 \cos \phi - 2 \cos \theta)}}. \end{aligned}$$

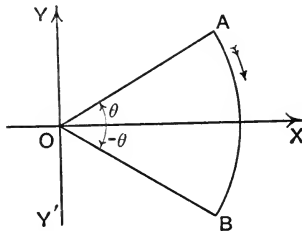

FIG. 50.

In this equation let θ and ϕ be replaced by $\pi - \theta$ and $\pi - \phi$; then

$$P_n(\cos \theta) = \frac{2}{\pi} \int_{\theta}^{\pi} \frac{\sin(n + \frac{1}{2})\phi d\phi}{\sqrt{(2 \cos \theta - 2 \cos \phi)}}.$$

Example 1. Prove

$$(n+1)P_{n+1}(\zeta) - (2n+1)\zeta P_n(\zeta) + nP_{n-1}(\zeta) = 0.$$

Differentiate $(1 - 2\zeta z + z^2)^{-1/2} = \sum_0^{\infty} z^n P_n(\zeta)$ with regard to z : then

$$\frac{\zeta - z}{(1 - 2\zeta z + z^2)^{3/2}} = \sum_1^{\infty} n z^{n-1} P_n(\zeta).$$

Now multiply both sides by $(1 - 2\zeta z + z^2)$: then

$$\begin{aligned} \frac{\zeta - z}{\sqrt{(1 - 2\zeta z + z^2)}} &= P_1(\zeta) + z\{2P_2(\zeta) - 2\zeta P_1(\zeta)\} \\ &\quad + \sum_{n=2}^{\infty} z^n \{(n+1)P_{n+1}(\zeta) - 2n\zeta P_n(\zeta) + (n-1)P_{n-1}(\zeta)\}. \end{aligned}$$

But

$$\frac{\zeta - z}{\sqrt{(1 - 2\zeta z + z^2)}} = \zeta P_0(\zeta) + z\{\zeta P_1(\zeta) - P_0(\zeta)\} + \sum_{n=1}^{\infty} z^{n+1} \{\zeta P_{n+1}(\zeta) - P_n(\zeta)\}.$$

Hence equating coefficients, we have

$$(n+1)P_{n+1}(\zeta) - (2n+1)\zeta P_n(\zeta) + nP_{n-1}(\zeta) = 0, \quad (n=0, 1, 2, \dots).$$

Example 2. Prove $P_n(\zeta) = F\left(n+1, -n, 1, \frac{1-\zeta}{2}\right)$, (Cf. § 36, Ex. 1.)

$$\begin{aligned} (1 - 2\zeta z + z^2)^{-1/2} &= \{(1-z)^2 + 2z(1-\zeta)\}^{-1/2} = \frac{1}{1-z} \left\{1 + \frac{4z}{(1-z)^2} \frac{1-\zeta}{2}\right\}^{-1/2} \\ &= \sum_{n=0}^{\infty} \frac{(-1)^n}{1-z} \frac{1 \cdot 3 \dots (2n-1)}{2 \cdot 4 \dots 2n} \left\{\frac{4z}{(1-z)^2} \frac{1-\zeta}{2}\right\}^n. \end{aligned}$$

Therefore, equating the coefficients of z^n , we have

$$\begin{aligned} P_n(\xi) &= 1 - \frac{1}{2} \frac{n(n+1)}{2!} \left(4 \cdot \frac{1-\xi}{2}\right) + \frac{1 \cdot 3}{2 \cdot 4} \frac{(n-1)n(n+1)(n+2)}{4!} \left(4 \cdot \frac{1-\xi}{2}\right)^2 - \dots \\ &= 1 + \frac{(n+1)(-n)}{1 \cdot 1} \left(\frac{1-\xi}{2}\right) + \frac{(n+1)(n+2)(-n)(-n+1)}{1 \cdot 2 \cdot 1 \cdot 2} \left(\frac{1-\xi}{2}\right)^2 + \dots \\ &= F\left(n+1, -n, 1, \frac{1-\xi}{2}\right). \end{aligned}$$

Example 3. From *Example 2* deduce

$$P_n(\xi) = (-1)^n F\left(n+1, -n, 1, \frac{1+\xi}{2}\right).$$

47. Expansion of $\cot z$ in a Series of Fractions. The function $\cot z/(\xi-z)$, where $\xi \neq n\pi$, has simple poles at ξ and $n\pi$, ($n=0, \pm 1, \pm 2, \dots$): the residues at these points are $-\cot \xi$ and $1/(\xi-n\pi)$ respectively.

Now consider the integral $\int_{\xi-z}^{\cot z} dz$ taken round the rectangle ABCD (Fig. 51) of sides $x = \pm(n+1/2)\pi$, $y = \pm b$, where n and b are chosen so that ξ lies within the rectangle.

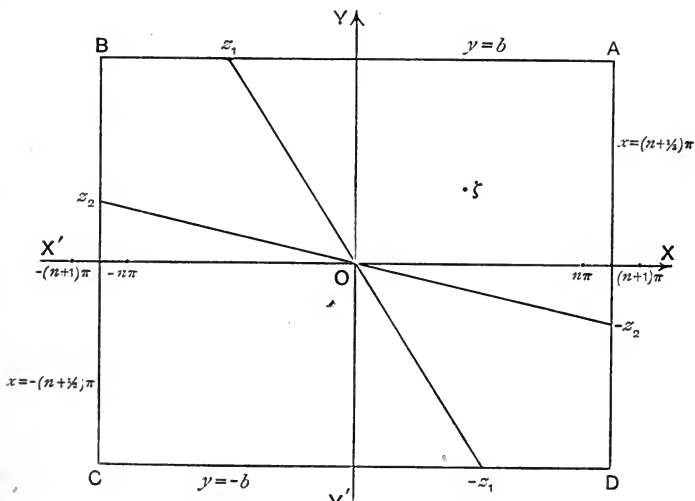

FIG. 51.

To each point z on AB or BC there corresponds a point $-z$ on CD or DA: therefore

$$\int_{ABCD} \frac{\cot z dz}{\xi-z} = I_1 + I_2,$$

where
$$I_1 = \int_{AB} \cot z \frac{2\xi}{\xi^2 - z^2} dz, \quad I_2 = \int_{BC} \cot z \frac{2\xi}{\xi^2 - z^2} dz.$$

On AB, $z = x + ib$; therefore

$$|\cot z| = \left| i \frac{e^{ix-b} + e^{-ix+b}}{e^{ix-b} - e^{-ix+b}} \right| \leq \frac{e^b + e^{-b}}{e^b - e^{-b}} = \frac{1 + e^{-2b}}{1 - e^{-2b}}.$$

Hence $|I_1| \leq \int_{-(n+1/2)\pi}^{(n+1/2)\pi} \frac{1 + e^{-2b}}{1 - e^{-2b}} \frac{2r dx}{x^2 + b^2 - r^2}$, where $r = |\xi|$.

To avoid discontinuous values of the integrand, we choose $b > r$; then

$$|I_1| \leq \frac{1 + e^{-2b}}{1 - e^{-2b}} \int_{-\infty}^{+\infty} \frac{2r dx}{x^2 + b^2 - r^2} = \frac{1 + e^{-2b}}{1 - e^{-2b}} \frac{2r}{\sqrt{b^2 - r^2}} \pi$$

Therefore

$$\lim_{b \rightarrow \infty} I_1 = 0.$$

Again, on BC, $z = -(n+1/2)\pi + iy$, so that

$$|\cot z| = |-\tan iy| = \left| -\frac{1 e^{-y} - e^y}{i e^{-y} + e^y} \right| \leq 1.$$

Hence $|I_2| \leq \int_{-b}^b \frac{2r dy}{y^2 + (n+1/2)^2 \pi^2 - r^2}$,

where n is chosen so great that $(n+1/2)\pi > r$. Thus

$$|I_2| \leq \int_{-\infty}^{+\infty} \frac{2r dy}{y^2 + (n+1/2)^2 \pi^2 - r^2} = \frac{2r}{\sqrt{\{(n+1/2)^2 \pi^2 - r^2\}}} \pi.$$

Therefore

$$\lim_{n \rightarrow \infty} I_2 = 0.$$

But

$$\begin{aligned} \int_{ABCD} \frac{\cot z dz}{\xi - z} &= 2\pi i \left(-\cot \xi + \sum_{-n}^n \frac{1}{\xi - n\pi} \right) \\ &= 2\pi i \left(-\cot \xi + \frac{1}{\xi} + \sum_1^n \frac{2\xi}{\xi^2 - n^2 \pi^2} \right); \end{aligned}$$

and $\sum_1^n \frac{1}{\xi^2 - n^2 \pi^2}$ tends to a definite value as n tends to infinity (§ 43, Example 2). Accordingly, when n and b tend to infinity, we have

$$0 = 2\pi i \left(-\cot \xi + \frac{1}{\xi} + \sum_1^{\infty} \frac{2\xi}{\xi^2 - n^2 \pi^2} \right);$$

and therefore

$$\cot \xi = \frac{1}{\xi} + \sum_1^{\infty} \frac{2\xi}{\xi^2 - n^2 \pi^2}.$$

Example 1. Shew that $\operatorname{cosec}^2 \xi = \sum_{-n}^{+n} \frac{1}{(\xi - n\pi)^2}$.

Example 2. Integrate $\frac{1}{(\xi - z) \sin z}$ round the contour of Fig. 51, and prove

$$\operatorname{cosec} \xi = \frac{1}{\xi} + \sum_{n=1}^{\infty} \frac{(-1)^n 2\xi}{\xi^2 - n^2 \pi^2}.$$

48. Mittag-Leffler's Theorem. It is possible to construct a function which shall be holomorphic except at isolated simple poles a_1, a_2, a_3, \dots , these poles being arranged in order of ascending moduli, provided that, for some integer n , the series $\sum_{r=1}^{\infty} 1/a_r^n$ is absolutely convergent.

Consider the series $\sum_{r=1}^{\infty} w_r(z)$, where

$$w_r(z) = \frac{1}{z-a_r} + \frac{1}{a_r} + \frac{z}{a_r^2} + \dots + \frac{z^{n-2}}{a_r^{n-1}} = \frac{z^{n-1}}{a_r^{n-1}} \cdot \frac{1}{z-a_r}.$$

Let C be the circle $|z| = R$, where $R < |a_{p+1}|$; then, for all points z in the region bounded by C ,

$$\left| \frac{z}{a_r} - 1 \right| \geq \mu, \text{ where } \mu = 1 - \frac{R}{|a_{p+1}|},$$

and $r = p+1, p+2, \dots$. Therefore

$$|w_r(z)| \leq \frac{R^{n-1}}{\mu} \frac{1}{|a_r|^n}, \quad (r = p+1, p+2, \dots).$$

Hence, by Weierstrass's M Test, the series $\sum_{p+1}^{\infty} w_r(z)$ converges absolutely and uniformly in the region bounded by C .

Accordingly, the series $\sum_{r=1}^{\infty} w_r(z)$ represents a function of the required type in this region. But R can always be chosen so large that any assigned point lies in the region: hence the series represents a function of the required type.

COROLLARY 1. If $f(z)$ and $\phi(z)$ are two functions with simple poles of residue unity at a_1, a_2, a_3, \dots , $f(z) - \phi(z)$ is holomorphic at all finite points, and is therefore an integral function. Hence any function of this type can be put in the form

$$\sum_{r=1}^{\infty} \left(\frac{1}{z-a_r} + \frac{1}{a_r} + \frac{z}{a_r^2} + \dots + \frac{z^{n-2}}{a_r^{n-1}} \right) + G(z),$$

where $G(z)$ is an integral function.

COROLLARY 2. If the function

$$\sum_{r=1}^{\infty} \left(\frac{1}{z-a_r} + \frac{1}{a_r} + \frac{z}{a_r^2} + \dots + \frac{z^{n-2}}{a_r^{n-1}} \right)$$

is differentiated $p-1$ times, a function is obtained with poles of order p at the points a_1, a_2, a_3, \dots .

Note. These functions have all essential singularities at infinity, since there is an infinite number of poles exterior to every circle $|z| = R$, (§ 22, Theorem 1, Cor. 2).

Example 1. Since the series $\sum_{r=1}^{\infty} 1/r^2$ is convergent, the function

$$\sum_{r=1}^{\infty} \left(\frac{1}{z-r} + \frac{1}{r} \right)$$

is holomorphic at all points except $1, 2, 3, \dots$, where it has simple poles.

Example 2. Shew that

$$\cot z = \frac{1}{z} + \sum_{-\infty}^{+\infty} \left(\frac{1}{z-n\pi} + \frac{1}{n\pi} \right). \quad [\text{Use § 47.}]$$

Weierstrass's Zeta Function. If $\sum_{-\infty}^{+\infty} 1/\Omega^3$ is the absolutely convergent series of § 37, where $\Omega = 2m\omega_1 + 2n\omega_2$, then, by Mittag-Leffler's Theorem,

$$\frac{1}{z} + \sum_{-\infty}^{+\infty} \left(\frac{1}{z-\Omega} + \frac{1}{\Omega} + \frac{z}{\Omega^2} \right)$$

is a meromorphic function with simple poles at the angular points of the network of Fig. 42. This function is *Weierstrass's Zeta Function*, and is denoted by $\zeta(z)$, (cf. § 75).

The function is odd. For, if the order of summation is reversed; i.e. if m and n are replaced by $-m$ and $-n$; then

$$\zeta(z) = \frac{1}{z} + \sum_{-\infty}^{+\infty} \left(\frac{1}{z+\Omega} - \frac{1}{\Omega} + \frac{z}{\Omega^2} \right).$$

$$\text{Hence } \zeta(-z) = - \left\{ \frac{1}{z} + \sum_{-\infty}^{+\infty} \left(\frac{1}{z-\Omega} + \frac{1}{\Omega} + \frac{z}{\Omega^2} \right) \right\} = -\zeta(z).$$

Weierstrass's Elliptic Function. Differentiating the Zeta Function, we have

$$-\zeta'(z) = \frac{1}{z^2} + \sum_{-\infty}^{+\infty} \left\{ \frac{1}{(z-\Omega)^2} - \frac{1}{\Omega^2} \right\}.$$

This is *Weierstrass's Elliptic Function* $\wp(z)$, (cf. § 72), so that

$$\wp(z) = -\zeta'(z).$$

It is holomorphic except for poles of the second order at the points $2m\omega_1 + 2n\omega_2$, where m and n take all integral values. Since $\wp(-z) = \wp(z)$, $\wp(z)$ is an even function.

49. Infinite Products. Let P_n denote the product $\prod_{r=1}^n w_r$, where the w 's are complex quantities no one of which is zero. Then if the sequence P_1, P_2, P_3, \dots , tends to the non-zero limit P as n tends to infinity, the infinite product $\prod w_r$ is said to converge to the limit P .

If P is zero, the product is defined to be divergent.

If $\prod_{r=1}^{\infty} w_r$ is convergent, $\lim_{n \rightarrow \infty} w_n = 1$; for $w_n = P_n/P_{n-1}$, and P_n and P_{n-1} both tend to the limit P .

THEOREM I. If the series $\dot{S} = \sum_1^{\infty} w_n$ is convergent, the product $\prod_1^{\infty} e^{w_n}$ will be convergent and will have the value e^S .

For, since the exponential function is continuous, an η can be found such that, if

$$\left| \sum_{r=1}^n w_r - S \right| < \eta,$$

$$\left| \prod_{r=1}^n e^{w_r} - e^S \right| = \left| e^{\sum_1^n w_r} - e^S \right| < \epsilon.$$

Hence $\prod_1^{\infty} e^{w_n}$ converges to e^S .

Unconditional Convergence. If the series $\sum w_n$ is absolutely convergent its value is independent of the order of summation of the terms, and therefore the value of the infinite product $\prod e^{w_n}$ is independent of the order of the factors. When this is the case the infinite product is said to be *Unconditionally Convergent*.

Example. Shew that, if the series $\sum_1^{\infty} w_n$ is absolutely convergent, the product $\prod_1^{\infty} (1 + w_n)$ is unconditionally convergent.

[Use *Example 3*, § 36.]

THEOREM II. If the terms of the series $S(z) = \sum_1^{\infty} w_n(z)$ are holomorphic in a given region, and if the series converges uniformly in that region, the infinite product $P(z) = \prod_1^{\infty} e^{w_n(z)}$ will be holomorphic at all interior points of the region.

For $S(z)$ is holomorphic at all such points; hence $P(z) = e^{S(z)}$ is also holomorphic (§ 15, p. 30), and its logarithmic derivative is given by

$$\frac{P'(z)}{P(z)} = \frac{dS(z)}{dz} = \sum_1^{\infty} w_n'(z).$$

50. Weierstrass's Theorem. It is possible to construct an integral function with zeros of the first order at the isolated points a_1, a_2, a_3, \dots , these points being arranged in order of ascending moduli, provided that, for some integer n , the series

$\sum_{r=1}^{\infty} 1/a_r^n$ is absolutely convergent.

$$\text{Let } w_r(z) = \frac{1}{z-a_r} + \frac{1}{a_r} + \frac{z}{a_r^2} + \dots + \frac{z^{n-2}}{a_r^{n-1}}, \quad (r=1, 2, 3, \dots).$$

Then the series $\sum_{p+1}^{\infty} w_r(z)$ converges (§ 48) absolutely and uniformly in the region bounded by the circle $|z|=R$, where $R < |a_{p+1}|$. Now let

$$W_r(z) = \int_0^z w_r(z) dz = \left\{ \log\left(1 - \frac{z}{a_r}\right) + \frac{z}{a_r} + \frac{1}{2} \frac{z^2}{a_r^2} + \dots + \frac{1}{n-1} \frac{z^{n-1}}{a_r^{n-1}} \right\},$$

($r=p+1, p+2, \dots$), where the path of integration lies in the circle.

Then the function $\sum_{p+1}^{\infty} W_r(z)$ is holomorphic in that region, and therefore (§ 49, Theorem II) so is the infinite product $\prod_{p+1}^{\infty} e^{W_r(z)}$.

Hence the function

$$\prod_1^{\infty} \left\{ \left(1 - \frac{z}{a_r}\right) e^{\frac{z}{a_r} + \frac{1}{2} \frac{z^2}{a_r^2} + \dots + \frac{1}{n-1} \frac{z^{n-1}}{a_r^{n-1}}} \right\}$$

is holomorphic in the circle, and has simple zeros at the points a_1, a_2, \dots, a_p .

Now R can be chosen so large that the circle includes any assigned point; hence the theorem holds for all finite points.

Again, let $f(z)$ be any function of the required type. Then if $\phi(z)$ denotes the infinite product above, $f(z)/\phi(z)$ will be an integral function without zeros, and will therefore (§ 42) be expressible in the form $e^{G(z)}$, where $G(z)$ is integral.

Accordingly, the most general function of the required type is

$$e^{G(z)} \prod_1^{\infty} \left\{ \left(1 - \frac{z}{a_r}\right) e^{\frac{z}{a_r} + \frac{1}{2} \frac{z^2}{a_r^2} + \dots + \frac{1}{n-1} \frac{z^{n-1}}{a_r^{n-1}}} \right\};$$

or
$$e^{G(z)} z \prod_1^{\infty} \left\{ \left(1 - \frac{z}{a_r}\right) e^{\frac{z}{a_r} + \frac{1}{2} \frac{z^2}{a_r^2} + \dots + \frac{1}{n-1} \frac{z^{n-1}}{a_r^{n-1}}} \right\},$$

if there is a zero at the origin.

Example. From *Example 2*, § 48, we have

$$\cot z - \frac{1}{z} = \sum_{-\infty}^{+\infty} \left(\frac{1}{z - n\pi} + \frac{1}{n\pi} \right).$$

Hence $\int_0^z \left(\cot z - \frac{1}{z} \right) dz = \sum_{-\infty}^{+\infty} \int_0^z \left(\frac{1}{z - n\pi} + \frac{1}{n\pi} \right) dz$;

or $\log \frac{\sin z}{z} = \sum_{-\infty}^{+\infty} \left\{ \log \left(1 - \frac{z}{n\pi} \right) + \frac{z}{n\pi} \right\}$.

Therefore $\sin z = z \prod_{-\infty}^{+\infty} \left\{ \left(1 - \frac{z}{n\pi} \right) e^{\frac{z}{n\pi}} \right\} = z \prod_1^{\infty} \left(1 - \frac{z^2}{n^2\pi^2} \right)$.

Note. We cannot put $\sin z = z \prod_{-\infty}^{\infty} (1 - z/n\pi)$: for, since the series $\sum \{1/(z - n\pi)\}$ is not convergent, the infinite product is not convergent.

The Gamma Function. We define the Gamma Function $\Gamma(z)$ by means of the equation

$$\frac{1}{\Gamma(z)} = e^{\gamma z} z \prod_1^{\infty} \left\{ \left(1 + \frac{z}{n} \right) e^{-\frac{z}{n}} \right\},$$

where γ is Euler's Constant. The expression on the right-hand side of the equation is integral, and has simple zeros at the points $0, -1, -2, -3, \dots$: thus $\Gamma(z)$ is holomorphic except at the isolated simple poles $0, -1, -2, -3, \dots$, and has no zeros in the finite part of the plane, (cf. § 61).

The Sigma Function. The method employed in the proof of Weierstrass's Theorem, when applied to Weierstrass's Zeta Function (§ 48), leads to the integral function

$$z \prod_{-\infty}^{+\infty} \left\{ \left(1 - \frac{z}{\Omega} \right) e^{\frac{z}{\Omega} + \frac{1}{2} \frac{z^2}{\Omega^2}} \right\},$$

with simple zeros at the points $2m\omega_1 + 2n\omega_2$, where m and n take all integral values. This is Weierstrass's Sigma Function, denoted by $\sigma(z)$. By logarithmic differentiation, it follows that $\sigma'(z)/\sigma(z) = \zeta(z)$. As in the case of the zeta function, it can be shewn that $\sigma(-z) = -\sigma(z)$, so that $\sigma(z)$ is odd, (cf § 76).

EXAMPLES VI.

1. Shew that the series

$$\frac{1}{z} - \frac{1}{1!z+1} + \frac{1}{2!z+2} - \frac{1}{3!z+3} + \dots$$

represents a meromorphic function with poles at the points

$$0, -1, -2, -3, \dots$$

2. Shew that the series $\sum_0^{\infty} z^n/n!$ represents a holomorphic function at all finite points of the plane, and deduce that

$$\frac{d}{dz} \exp(z) = \exp(z).$$

3. If $|z| < 1$, prove $\int_0^z \frac{dz}{1+z^2} = z - \frac{z^3}{3} + \frac{z^5}{5} - \dots$.

4. If z_1 lies within the circle of convergence of the series $\sum_0^{\infty} c_n(z-a)^n$, shew that the Taylor's Series for the function at z_1 is $\sum_0^{\infty} c_n'(z-z_1)^n$, where

$$c_n' = \sum_{r=0}^{\infty} c_{n+r} \frac{(n+r)!}{n!r!} (z_1-a)^r.$$

5. Prove that the residues of e^z at the origin and at infinity are both zero.

6. Shew that, if A and B are the residues of $e^{1/z}z^n/(1+z)$ at $z=0$ and $z=\infty$:

$$(i) A + B + (-1)^n e^{-1} = 0;$$

$$(ii) A = (-1)^{n+1} e^{-1} + \frac{1}{n!} - \frac{1}{(n-1)!} + \dots + (-1)^n \frac{1}{2!}.$$

7. Shew that the residue of $e^z \log\left(\frac{z-\alpha}{z-\beta}\right)$ at infinity is $(e^\alpha - e^\beta)$.

8. Shew that

$$(i) \int_0^{\infty} \frac{(x^4 + 3x^2 + 1) \cos x}{(x^4 + x^2 + 1)^2} dx = \frac{\pi}{3} \left(1 + \frac{2}{\sqrt{3}}\right) e^{-\frac{\sqrt{3}}{2}} \cos\left(\frac{1}{2}\right);$$

$$(ii) \int_0^{\infty} \frac{x(x^2 + 1) \sin x}{(x^4 + x^2 + 1)^2} dx = \frac{\pi}{6} \left(1 + \frac{2}{\sqrt{3}}\right) e^{-\frac{\sqrt{3}}{2}} \sin\left(\frac{1}{2}\right).$$

[Integrate $e^{iz}/(z^2+z+1)^2$ round the contour of Fig. 33.]

9. If $a > 0$, prove $\int_0^{\infty} \frac{dx}{(x^2+a)^2} = \frac{\pi}{4a^3}$.

10. If $a > 1$, prove $\int_0^{2\pi} \frac{d\theta}{(a + \cos \theta)^2} = \frac{2\pi a}{(a^2 - 1)^{3/2}}$.

11. If $a > b > 0$, shew that

$$\int_0^{2\pi} \frac{\sin^2 \theta d\theta}{a + b \cos \theta} = \frac{2\pi}{b^2} (a - \sqrt{a^2 - b^2}).$$

12. Prove $\int_0^{\infty} \frac{dx}{(x^2+1)^3} = \frac{3\pi}{16}$.

13. Prove $\int_0^{\infty} \frac{x^2 dx}{(x^2+1)^3} = \frac{\pi}{16}$.

14. If a and b are positive, shew that

$$\int_{-\infty}^{+\infty} \frac{dx}{(x^2+b^2)(x^2+a^2)^2} = \frac{\pi(2a+b)}{2a^3b(a+b)^2}.$$

15. Shew that, if $m \geq 0$,

$$\int_0^{\infty} \frac{\cos mx dx}{(1+x^2)^2} = \frac{\pi}{4} (1+m) e^{-m}.$$

16. Shew that $\int_0^{\infty} \frac{\cos^2 x dx}{(1+x^2)^2} = \frac{\pi}{8} (1+3e^{-2})$.

17. Shew that, if a and m are positive,

$$\int_0^{\infty} \frac{\sin^2 mx \, dx}{x^2(a^2+x^2)^2} = \frac{\pi}{8a^3} \{e^{-2ma}(2ma+3) + 4ma - 3\}.$$

18. If $-2\pi < c < 2\pi$, prove

$$\int_0^{\infty} \frac{\cosh cx}{\cosh^2 \pi x} \, dx = \frac{c}{2\pi \sin(c/2)}.$$

19. Integrate $\frac{z \log(1-iz)}{(1+2z^2)^2}$ round the contour of Fig. 33, and shew that

$$\int_0^{\infty} \frac{x \tan^{-1} x \, dx}{(1+2x^2)^2} = \int_0^1 \frac{x \sin^{-1} x \, dx}{(1+x^2)^2} = \frac{\pi}{8}(\sqrt{2}-1).$$

20. Integrate $\frac{\sqrt{z} \operatorname{Log} z}{(1+z)^2}$, where $0 < \operatorname{amp} z < 2\pi$, round the contour of

Fig. 38, and shew that

$$\int_0^{\infty} \frac{\sqrt{x} \log x}{(1+x)^2} \, dx = \pi, \quad \int_0^{\infty} \frac{\sqrt{x} \, dx}{(1+x)^2} = \frac{\pi}{2}.$$

21. Prove $\int_0^1 \frac{x^{2n} \, dx}{\sqrt[3]{x(1-x^2)}} = \begin{cases} \frac{\pi}{\sqrt{3}} \frac{1 \cdot 4 \cdot 7 \dots (3n-2)}{3 \cdot 6 \cdot 9 \dots 3n}, & \text{if } n \geq 1; \\ \frac{\pi}{\sqrt{3}}, & \text{if } n=0. \end{cases}$

22. Prove $\sum_{n=-\infty}^{+\infty} \frac{a}{(z+n\pi)^2+a^2} = \frac{\sinh 2a}{\cosh 2a - \cos 2z}$.

23. Prove $\coth z = \frac{1}{z} + \sum_1^{\infty} \frac{2z}{z^2+n^2\pi^2}$;

and deduce $\frac{2}{e^z - e^{-z}} = \frac{1}{z} - \frac{2z}{z^2+\pi^2} + \frac{2z}{z^2+4\pi^2} - \frac{2z}{z^2+9\pi^2} + \dots$

24. If n is a positive even integer, prove, by integrating $\frac{e^{inz}}{(z^2+1)\sin z}$ round a suitable contour, that

$$\int_0^{\infty} \frac{\sin nx}{\sin x} \frac{dx}{x^2+1} = \pi \frac{e^n - 1}{(e^2 - 1)e^{n-1}}.$$

25. Prove $\operatorname{cosec} z = \frac{1}{z} + \sum_{-\infty}^{+\infty} (-1)^n \left(\frac{1}{z-n\pi} + \frac{1}{n\pi} \right)$.

26. Construct a function $f(z)$ which is holomorphic except at the poles $z = \pm 1, \pm 2, \pm 3, \dots$, and is such that $f(z) - z \cot \pi z$ tends to zero at each of these points.

$$\text{Ans. } \frac{1}{\pi} + \frac{1}{\pi} \sum_{-\infty}^{+\infty} \left\{ \frac{n}{z-n} + 1 + \frac{z}{n} \right\}.$$

27. Prove $\cos z = \prod_1^{\infty} \left\{ 1 - \frac{4z^2}{(2n-1)^2\pi^2} \right\}$.

28. Shew that $\tan z = \frac{z \prod_{-\infty}^{+\infty} \left\{ \left(1 - \frac{z}{n\pi} \right) e^{\frac{z}{n\pi}} \right\}}{\prod_{-\infty}^{+\infty} \left[\left\{ 1 - \frac{2z}{(2n-1)\pi} \right\} e^{\frac{2z}{(2n-1)\pi}} \right]}$

29. Prove that, if $|z| < 1$,

$$(1+z)(1+z^2)(1+z^4)(1+z^8)\dots = 1/(1-z).$$

30. Verify that :

$$(i) \cos \frac{z}{2} \cos \frac{z}{2^2} \cos \frac{z}{2^3} \dots = \frac{\sin z}{z};$$

$$(ii) \frac{1}{2} \tan \frac{z}{2} + \frac{1}{2^2} \tan \frac{z}{2^2} + \frac{1}{2^3} \tan \frac{z}{2^3} + \dots = \frac{1}{z} - \cot z.$$

31. Prove that, if $w_n = \frac{(n+a_1)(n+a_2)\dots(n+a_k)}{(n+b_1)(n+b_2)\dots(n+b_l)}$,

the product $\prod_1^\infty w_n$ is convergent provided $k=l$ and $\Sigma a = \Sigma b$.

32. If $|z| < \pi$, shew that

$$\log \left(\frac{z}{\sin z} \right) = H_2 \frac{z^2}{\pi^2} + \frac{1}{2} H_4 \frac{z^4}{\pi^4} + \frac{1}{3} H_6 \frac{z^6}{\pi^6} + \dots$$

where

$$H_{2n} = \frac{1}{1^{2n}} + \frac{1}{2^{2n}} + \frac{1}{3^{2n}} + \dots$$

Deduce that, if $0 < |z| < \pi$,

$$\cot z = \frac{1}{z} - 2H_2 \frac{z}{\pi^2} - 2H_4 \frac{z^3}{\pi^4} - 2H_6 \frac{z^5}{\pi^6} - \dots$$

CHAPTER VII.

VARIOUS SUMMATIONS AND EXPANSIONS.

51. Expansions in Series by means of Residues. The theory of residues has been applied in § 47 to the expansion of various functions in series of fractions. The following theorems enable us to shorten this process considerably.

THEOREM 1. Let $z = Re^{i\theta}$ lie on that arc of the circle $|z| = R$ for which $\theta_1 \leq \theta \leq \theta_2$, and let $zf(z)$, as R tends to infinity, tend uniformly to the limit K , a constant, at all points of the arc, with the possible exception of the points for which $\alpha - \epsilon \leq \theta \leq \alpha + \epsilon$ (ϵ arbitrarily small). Also let $|zf(z)| \leq M$, where M is finite, at all points of the arc. Then

$$\lim_{R \rightarrow \infty} \int_{\theta_1}^{\theta_2} f(z) dz = i(\theta_2 - \theta_1) K.$$

For (Theorem I. § 30),

$$\lim_{R \rightarrow \infty} \left\{ \int_{\theta_1}^{\alpha - \epsilon} f(z) dz + \int_{\alpha + \epsilon}^{\theta_2} f(z) dz \right\} = i(\theta_2 - \theta_1) K - 2i\epsilon K;$$

and

$$\left| \int_{\alpha - \epsilon}^{\alpha + \epsilon} f(z) dz \right| \leq 2\epsilon M.$$

$$\text{Hence } \left| \lim_{R \rightarrow \infty} \left\{ \int_{\theta_1}^{\theta_2} f(z) dz \right\} - i(\theta_2 - \theta_1) K \right| \leq 2\epsilon(|K| + M).$$

$$\text{Therefore } \lim_{R \rightarrow \infty} \int_{\theta_1}^{\theta_2} f(z) dz = i(\theta_2 - \theta_1) K.$$

The theorem also holds if there is a finite number of exceptional values of θ such as α .

Example. Integrate $f(z) = e^{iz}/z$ round the contour of Fig. 52, consisting of the positive x and y axes and quadrants of the circles $|z| = R$ and $|z| = r$.

On the large circle, if $\epsilon \leq \theta \leq \pi/2$, $|zf(z)| \leq e^{-R \sin \epsilon}$; so that $zf(z)$ tends

uniformly to the limit zero as R tends to infinity. Also, for all points on the quadrant

$$|zf(z)| = e^{-R \sin \theta} \leq 1.$$

Therefore

$$\lim_{R \rightarrow \infty} \int_{\theta=0}^{\theta=\pi/2} f(z) dz = 0.$$

Hence

$$\int_0^{\infty} \frac{e^{ix} - e^{-x}}{x} dx - \frac{i\pi}{2} = 0;$$

so that, if the real and imaginary parts are equated,

$$\int_0^{\infty} \frac{\cos x - e^{-x}}{x} dx = 0, \quad \int_0^{\infty} \frac{\sin x}{x} dx = \frac{\pi}{2}.$$

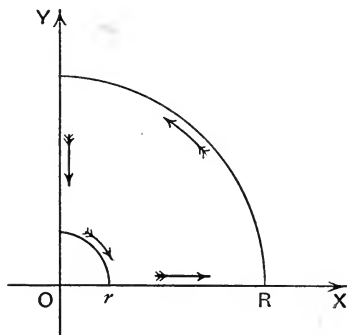

FIG. 52.

Lemma. The function $\cot \pi z$ has simple poles at the points $0, \pm 1, \pm 2, \dots$. Let these poles be surrounded by circles of radius r , where $r < 1/2$; then a positive quantity M can be found such that $|\cot \pi z| \leq M$ for all points exterior to these circles.

For (Examples III., 11), $|\cot \pi z| \leq |\coth \pi y|$: hence, if

$$y \geq a, \quad (a > 0), \quad \text{or} \quad y \leq -a, \quad |\cot \pi z| \leq \coth \pi a.$$

Now consider the region (Fig. 53) between the rectangle of sides $x = \pm 1/2, y = \pm a, (a > r)$, and the circle $|z| = r$. In this region, since $|\cot \pi z| \leq \cosh \pi y / \sqrt{(\sin^2 \pi x + \sinh^2 \pi y)}$

$$|\cot \pi z| \leq \cosh \pi a / \sin(\pi r / \sqrt{2}) \quad \text{if} \quad x \geq r / \sqrt{2} \quad \text{or} \quad \leq -r / \sqrt{2},$$

$$\text{and} \quad |\cot \pi z| \leq \cosh \pi a / \sinh(\pi r / \sqrt{2}) \quad \text{if} \quad y \geq r / \sqrt{2} \quad \text{or} \quad \leq -r / \sqrt{2}.$$

Accordingly, since unity is a period of $\cot \pi z$, $|\cot \pi z| \leq M$, where M is the greatest of the three quantities

$$\coth \pi a, \quad \cosh \pi a / \sin(\pi r / \sqrt{2}), \quad \cosh \pi a / \sinh(\pi r / \sqrt{2}),$$

for all points of the z -plane exterior to the given circles.

We leave the reader to prove that analogous properties hold for the functions: $\sec \pi z$, $\operatorname{cosec} \pi z$, $\tan \pi z$;

$$\frac{e^{rz}}{e^{\pi z} - 1}, \frac{e^{rz}}{e^{\pi z} + 1}, \text{ where } 0 \leq r \leq \pi.$$

$$\frac{\cos rz}{\cos \pi z}, \frac{\sin rz}{\sin \pi z}, \frac{\cos rz}{\sin \pi z}, \frac{\sin rz}{\cos \pi z}, \frac{e^{rz} + e^{-rz}}{e^{\pi z} - e^{-\pi z}}, \frac{e^{rz} - e^{-rz}}{e^{\pi z} - e^{-\pi z}},$$

where $-\pi \leq r \leq \pi$.

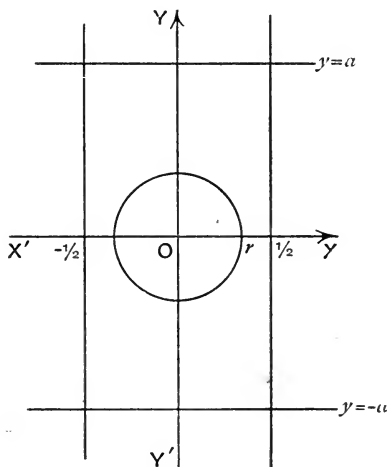

FIG. 53.

THEOREM 2. Let $f(z)$ be a meromorphic function, and let R_1, R_2, R_3, \dots , be the radii of a series of circles with the origin as centre, no one of which passes through a pole of $f(z)$, and such that $\lim_{n \rightarrow \infty} R_n = \infty$. Then if, as n tends to infinity, $zf(z)$ tends uniformly to the limit K for all points $z = R_n e^{i\theta}$ such that $\theta_1 \leq \theta \leq \theta_2$, with the possible exception of a finite number of sets of points $\alpha - \epsilon \leq \theta \leq \alpha + \epsilon$, and if $|zf(z)| \leq M$ for all points on the arc,

$$\lim_{n \rightarrow \infty} \int_{\theta_1}^{\theta_2} f(z) dz = i(\theta_2 - \theta_1)K.$$

The proof of this theorem is identical with that of Theorem 1, except that Lim is replaced by Lim .

Example 1. Let $f(z) = \cot \pi z / (\zeta - z)$ and $R_n = n + 1/2$. Then, since

$$\lim_{y \rightarrow \infty} \cot \pi z = -i, \quad \lim_{y \rightarrow -\infty} \cot \pi z = i,$$

it follows that $\lim_{n \rightarrow \infty} zf(z) = i$ if $\epsilon \leq \theta \leq \pi - \epsilon$ and $\lim_{n \rightarrow \infty} zf(z) = -i$ if

$$\pi + \epsilon \leq \theta \leq 2\pi - \epsilon.$$

Also, by the Lemma above, $|zf(z)| \leq M$ at all points of $|z| = R_n$. Hence

$$\lim_{n \rightarrow \infty} \int_0^{2\pi} \frac{\cot \pi z}{\xi - z} dz = 0;$$

and therefore, as in § 47,

$$\pi \cot \pi \xi = \frac{1}{\xi} + \sum_{n=1}^{\infty} \frac{2\xi}{\xi^2 - n^2}.$$

Example 2. If $0 < r < 1$, prove

$$\frac{e^{rx}}{e^x - 1} = \frac{1}{x} + \sum_1^{\infty} \frac{2x \cos 2n\pi r - 4n\pi \sin 2n\pi r}{x^2 + 4n^2\pi^2}.$$

52. Summation of Series by means of Residues. Since the residue of $\pi \cot \pi z$ at each of its poles is unity,

$$\sum_{r=m}^n f(r) = \frac{1}{2\pi i} \int_C \pi \cot(\pi z) f(z) dz - \Sigma,$$

where C is a contour enclosing the poles $m, m+1, \dots, n$, of $\cot \pi z$, and no others, $f(z)$ is meromorphic, and Σ denotes the sum of the residues of $\pi \cot(\pi z) f(z)$ at the poles of $f(z)$ within C .

Similarly

$$\sum_m^n f(r) = \int_C \frac{f(z) dz}{e^{2\pi iz} - 1} - \Sigma' = \int_C \frac{f(z) dz}{1 - e^{-2\pi iz}} - \Sigma'',$$

where Σ' and Σ'' are the residues of

$$2\pi i f(z)/(e^{2\pi iz} - 1) \quad \text{and} \quad 2\pi i f(z)/(1 - e^{-2\pi iz})$$

respectively at the poles of $f(z)$ within C .

Example 1. Prove $\sum_{-\infty}^{+\infty} \frac{1}{(x+n)^2} = \frac{\pi^2}{\sin^2 \pi x}$.

[Integrate $\pi \cot \pi z \cdot (x+z)^{-2}$ round the circle $|z| = R_n = n + 1/2$, and make n tend to infinity.]

Example 2. If a is positive, prove

$$\sum_{-\infty}^{+\infty} e^{-\pi a n^2} = \frac{1}{\sqrt{a}} \sum_{-\infty}^{+\infty} e^{-\pi n^2/a}.$$

Integrate $e^{-\pi a z^2}/(e^{2\pi iz} - 1)$ round the rectangle of sides $x = \pm(m+1/2)$, $y = \pm 1$. Then, when m tends to infinity,

$$\begin{aligned} \sum_{-\infty}^{+\infty} e^{-\pi a n^2} &= - \int_{-\infty}^{+\infty} \frac{e^{-\pi a(x+i)^2} dx}{e^{2\pi i(x+i)} - 1} + \int_{-\infty}^{+\infty} \frac{e^{-\pi a(x-i)^2} dx}{e^{2\pi i(x-i)} - 1} \\ &= \int_{-\infty}^{+\infty} e^{-\pi a(x+i)^2} \{1 + e^{2\pi i(x+i)} + e^{4\pi i(x+i)} + \dots\} dx \\ &\quad + \int_{-\infty}^{+\infty} e^{-\pi a(x-i)^2} \{e^{-2\pi i(x-i)} + e^{-4\pi i(x-i)} + \dots\} dx \\ &= \sum_0^{\infty} e^{-n^2\pi/a} \int_{-\infty}^{+\infty} e^{-\pi a(x+i-ni/a)^2} dx + \sum_1^{\infty} e^{-n^2\pi/a} \int_{-\infty}^{+\infty} e^{-\pi a(x-i+ni/a)^2} dx \\ &= \frac{1}{\sqrt{a}} \sum_{-\infty}^{+\infty} e^{-\pi n^2/a}. \quad (\text{Examples IV., 21.}) \end{aligned}$$

Example 3. Gauss's Sum. Let $S_n = \sum_{r=0}^{n-1} T_r$, where $T_r = e^{2\pi i r^2/n}$. Then $T_{n-r} = T_r$; so that $S_n = 2\Sigma_n$, where Σ_n stands for $\frac{1}{2}T_0 + T_1 + \dots + T_{\frac{n-1}{2}}$ or $\frac{1}{2}T_0 + T_1 + \dots + T_{\frac{n-2}{2}} + \frac{1}{2}T_{\frac{n}{2}}$ according as n is odd or even.

Now, $\Sigma_n - \frac{1}{2}T_0$ or $\Sigma_n - \frac{1}{2}T_0 - \frac{1}{2}T_{n/2}$, as the case may be, is equal to the integral of $e^{2\pi i z^2/n} / (e^{2\pi i z} - 1)$ taken round the rectangle ABCD (Fig. 54) of sides $x=0, x=n/2, y=\pm R$, indented at O and $n/2$.

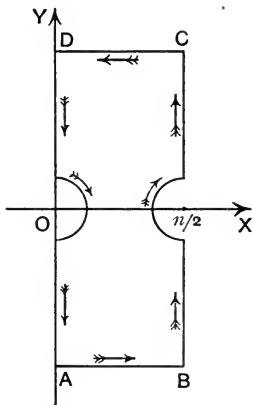

FIG. 54.

But $\left| \int_{CD} \frac{e^{2\pi i z^2/n} dz}{e^{2\pi i z} - 1} \right| < \int_0^{n/2} \frac{e^{-4\pi R x/n}}{1 - e^{-2\pi R}} dx < \frac{n}{4\pi R},$

and $\left| \int_{AB} \frac{e^{2\pi i z^2/n} dz}{e^{2\pi i z} - 1} \right| < \int_0^{n/2} \frac{e^{4\pi R x/n}}{e^{2\pi R} - 1} dx < \frac{n}{4\pi R};$

so that both of these integrals vanish when R tends to infinity.

Again, when R tends to infinity, the sum of the integrals along the straight parts of DA tends to

$$\begin{aligned} -i \int_0^\infty \left\{ \frac{e^{-2\pi i y^2/n}}{e^{-2\pi y} - 1} + \frac{e^{-2\pi i y^2/n}}{e^{2\pi y} - 1} \right\} dy &= i \int_0^\infty e^{-2\pi i y^2/n} dy \\ &= i \sqrt{\frac{n}{2\pi}} \left\{ \int_0^\infty \cos x^2 dx - i \int_0^\infty \sin x^2 dx \right\} \\ &= (1+i) \sqrt{n}/4. \quad (\S 30, \text{Example } 5.) \end{aligned}$$

Similarly, the integrals along the straight parts of BC give

$$\begin{aligned} i \int_0^\infty \frac{e^{2\pi i (n/2 + iy)^2/n}}{(-1)^n e^{-2\pi y} - 1} dy + i \int_0^\infty \frac{e^{2\pi i (n/2 - iy)^2/n}}{(-1)^n e^{2\pi y} - 1} dy &= i^{3n+1} \int_0^\infty e^{-2\pi i y^2/n} dy \\ &= i^{3n} (1+i) \sqrt{n}/4. \end{aligned}$$

Finally, the integrals along the small semi-circles at O and $n/2$ give $-\frac{1}{2}T_0$ and $-\frac{1}{2}T_{n/2}$ or $-\frac{1}{2}T_0$ and 0, according as n is even or odd. Hence

$$S_n = \frac{\sqrt{n}}{2} (1+i)(1+i^{3n}).$$

Another Summation Formula is

$$\sum_{r=m}^n (-1)^r f(r) = \frac{1}{2\pi i} \int_C \pi \operatorname{cosec}(\pi z) f(z) dz - \Sigma,$$

where C is a contour enclosing the poles $m, m+1, \dots, n$, of $\operatorname{cosec} \pi z$, and no others, and Σ denotes the sum of the residues of $\pi \operatorname{cosec}(\pi z) f(z)$ at the poles of $f(z)$ within C .

Example. Shew that, if a is any non-zero real quantity,

$$\sum_1^{\infty} (-1)^n \frac{n}{e^{\pi a n} - e^{-\pi a n}} = -\frac{1}{4\pi a} - \frac{1}{a^2} \sum_1^{\infty} (-1)^n \frac{n}{e^{\pi n/a} - e^{-\pi n/a}}.$$

Note. If a is small, the second series converges rapidly, while the first converges slowly.

53. Roots of Equations. The following three theorems lead up to the proof of Lagrange's Expansion.

THEOREM I. If $\phi(z)$ is meromorphic in a simply-connected region of boundary C , then, with the notation of § 31,

$$\Sigma r - \Sigma s = \Delta \Phi / 2\pi,$$

where $\Delta \Phi$ denotes the total increment of $\operatorname{amp} \{\phi(z)\}$ when z describes C positively.

$$\text{For } \Sigma r - \Sigma s = \frac{1}{2\pi i} \int_C \frac{\phi'(z)}{\phi(z)} dz = \frac{1}{2\pi i} \Delta \operatorname{Log} \phi(z),$$

where $\Delta \operatorname{Log} \phi(z)$ is the increment of $\operatorname{Log} \phi(z)$ when z passes round C . Hence, if $\phi(z) = R e^{i\Phi}$,

$$\Sigma r - \Sigma s = \frac{1}{2\pi i} \Delta \log R + \frac{1}{2\pi} \Delta \Phi.$$

But $\Delta \log R = 0$, since $\log R$ is uniform on C ; therefore

$$\Sigma r - \Sigma s = \Delta \Phi / 2\pi.$$

THEOREM II. Let $f(z)$ and $\phi(z)$ be holomorphic in a simply-connected region of boundary C , and let $f(z)$ be non-zero on C . Then, if $|\phi(z) \div f(z)| < 1$ for all points on C , $f(z)$ and $f(z) + \phi(z)$ will have the same number of zeros within C .

For, let $w = 1 + \phi(z)/f(z)$; then, as z describes C , w describes a closed contour in the w -plane about $w=1$, not enclosing the origin, and $\operatorname{amp} w$ returns to its original value.

Hence the increment of $\operatorname{amp} \{f(z) + \phi(z)\}$ is equal to the increment of $\operatorname{amp} \{f(z)\}$; and therefore, by Theorem I, these two functions have the same number of zeros within C .

THEOREM III. If $f(z)$ is holomorphic for $|z| < r$, and is not zero at the origin, a finite quantity ρ can be found such that, if $|w| \leq \rho$, the function $\psi(z, w) = z - wf(z)$, regarded as a function of z , has one and only one zero in the circle $|z| = r' < r$: and this zero is itself a holomorphic function of w for $|w| \leq \rho$.

For, let ρ be chosen so that, if $|z| = r'$,

$$|\psi(z, w) - \psi(z, 0)| = |wf(z)| < r',$$

provided $|w| \leq \rho$. Then

$$\left| \frac{\psi(z, w) - \psi(z, 0)}{\psi(z, 0)} \right| < 1;$$

so that, by Theorem II., if $|w| \leq \rho$, $\psi(z, w)$ has one and only one zero, ξ say, within $|z| = r'$.

Now, the integral

$$\frac{1}{2\pi i} \int z \frac{\frac{\partial}{\partial z} \psi(z, w)}{\psi(z, w)} dz = \frac{1}{2\pi i} \int z \frac{1 - wf'(z)}{z - wf(z)} dz, = \xi$$

taken round $|z| = r'$, is a holomorphic function of w (§ 34). But, if $|w| \leq \rho$, this integral has the value ξ (§ 31, Corollary 2). Hence ξ is a holomorphic function of w for $|w| \leq \rho$.

COROLLARY. If $F(z)$ is holomorphic for $|z| < r$, $F(\xi)$ is a holomorphic function of w for $|w| \leq \rho$, and

$$F(\xi) = \frac{1}{2\pi i} \int F(z) \frac{1 - wf'(z)}{z - wf(z)} dz,$$

where the integral is taken round $|z| = r'$, (§ 31).

54. Lagrange's Expansion. The results obtained in Theorem III. of the previous section can be stated thus: let $f(z)$ and $F(z)$ be holomorphic for $|z| < r$, and let $f(z)$ be non-zero for $z=0$; then, if z denotes that branch of the function of w given by $z = wf(z)$, which vanishes when $w=0$, a finite region $|w| \leq \rho$ of the w -plane can be found in which $F(z)$ is holomorphic. The Taylor's Series for $F(z)$ in this region can be found as follows.

Let C denote the circle $|z| = r'$; then

$$\begin{aligned} F(z) &= \frac{1}{2\pi i} \int_C F(z) \frac{1 - wf'(z)}{z - wf(z)} dz \\ &= \frac{1}{2\pi i} \int_C F(z) \{1 - wf'(z)\} \left[\frac{1}{z} + \frac{wf(z)}{z^2} + \frac{\{wf'(z)\}^2}{z^3} + \dots \right] dz, \end{aligned}$$

since $|wf(z)/z| < 1$,

$$\begin{aligned} &= \frac{1}{2\pi i} \int_C \frac{F(z)}{z} dz + \frac{1}{2\pi i} \sum_1^{\infty} \frac{w^n}{n} \int_C F(z) \left[-\frac{d}{dz} \left\{ \frac{f(z)}{z} \right\}^n \right] dz \\ &= \frac{1}{2\pi i} \int_C \frac{F(z)}{z} dz - \frac{1}{2\pi i} \sum_1^{\infty} \frac{w^n}{n} \int_C \frac{d}{dz} \left[F(z) \left\{ \frac{f(z)}{z} \right\}^n \right] dz \\ &\quad + \frac{1}{2\pi i} \sum_1^{\infty} \frac{w^n}{n} \int_C F'(z) \left\{ \frac{f(z)}{z} \right\}^n dz \\ &= F(0) + \sum_1^{\infty} \frac{w^n}{n!} \left[\frac{d^{n-1}}{dz^{n-1}} (F'(z) \{f(z)\}^n) \right]_{z=0}, \quad (\S 35), \end{aligned}$$

since all the integrals in the first series have the value zero, (§ 26, Cor. 8).

In particular, if $F(z) = z$,

$$z = \sum_1^{\infty} \frac{w^n}{n!} \left[\frac{d^{n-1}}{dz^{n-1}} \{f(z)\}^n \right]_{z=0}.$$

These are the well-known expansions of Lagrange.

If the origin be changed to the point $-\xi$, and $\phi(z)$ be written for $f(z - \xi)$, these expansions become

$$F(z) = F(\xi) + \sum_1^{\infty} \frac{w^n}{n!} \frac{d^{n-1}}{d\xi^{n-1}} [F'(\xi) \{\phi(\xi)\}^n]$$

and
$$z = \xi + \sum_1^{\infty} \frac{w^n}{n!} \frac{d^{n-1}}{d\xi^{n-1}} \{\phi(\xi)\}^n,$$

where z is that root of $z = \xi + w\phi(z)$ which has the value ξ when $w = 0$.

Example. Shew that the root of $z(1+z)^m = w$, which is zero when $w = 0$, is given by

$$z = w - \frac{2m}{2!} w^2 + \frac{3m(3m+1)}{3!} w^3 - \frac{4m(4m+1)(4m+2)}{4!} w^4 + \dots$$

Rodrigues' Formula for $P_n(\xi)$. If z is that root of

$$z = \xi + w(z^2 - 1)/2,$$

which has the value ξ , ($\xi \neq \pm 1$) when $w = 0$,

$$z = \xi + \sum_1^{\infty} \frac{w^n}{n!} \frac{d^{n-1}}{d\xi^{n-1}} \left(\frac{\xi^2 - 1}{2} \right)^n. \quad (i)$$

Before differentiating this series with regard to ξ , we must shew that a region can be found in the ξ -plane in which the series is uniformly convergent.

Let ξ be replaced in the expansion by $\lambda = ik$, where k is real and positive; then it follows from the theory of Lagrange's expansion that a value of ρ , say $\rho = \rho_1$, can be found such that the series

$$\lambda + \sum_1^{\infty} \frac{w^n}{n!} \frac{d^{n-1}}{d\lambda^{n-1}} \left(\frac{\lambda^2 - 1}{2} \right)^n$$

is absolutely convergent if $|w| \leq \rho_1$. Accordingly, by Weierstrass's M Test, since

$$\left| \frac{d^{n-1}}{d\xi^{n-1}} \left(\frac{\xi^2 - 1}{2} \right)^n \right| \leq \left| \frac{d^{n-1}}{d\lambda^{n-1}} \left(\frac{\lambda^2 - 1}{2} \right)^n \right|,$$

provided $|\xi| \leq k$, the series of equation (i) is absolutely and uniformly convergent in w and ξ for $|w| \leq \rho_1$ and for $|\xi| \leq k$; and k can always be chosen so that $|\xi| < k$. Hence (§ 43, Th. 3)

$$\frac{\partial z}{\partial \xi} = 1 + \sum_1^{\infty} \frac{w^n}{n!} \frac{d^n}{d\xi^n} \left(\frac{\xi^2 - 1}{2} \right)^n.$$

Now
$$z = \frac{1 - \sqrt{(1 - 2\xi w + w^2)}}{w},$$

where that branch of $\sqrt{(1 - 2\xi w + w^2)}$ is taken which has the value 1 when $w = 0$; therefore

$$\frac{\partial z}{\partial \xi} = \frac{1}{\sqrt{(1 - 2\xi w + w^2)}} = 1 + \sum_1^{\infty} w^n P_n(\xi). \tag{§ 46}$$

Hence, equating the coefficients of w^n in the two expansions for $\frac{\partial z}{\partial \xi}$, we have *Rodrigues' Formula*,

$$P_n(\xi) = \frac{1}{2^n n!} \frac{d^n}{d\xi^n} (\xi^2 - 1)^n.$$

By differentiating the product $(\xi^2 - 1)^n = (\xi - 1)^n (\xi + 1)^n$ n times it can be shewn that the formula is also true in the exceptional cases $\xi = \pm 1$.

COROLLARY.

$$P_n(\xi) = \frac{(2n)!}{2^n (n!)^2} \left\{ \xi^n - \frac{n(n-1)}{2(2n-1)} \xi^{n-2} + \frac{n(n-1)(n-2)(n-3)}{2 \cdot 4 \cdot (2n-1)(2n-3)} \xi^{n-4} - \dots \right\}.$$

Example 1. If $m \neq n$, $\int_{-1}^1 P_m(x)P_n(x)dx=0$.

For let $m > n$: then, by repeated partial integrations,

$$\begin{aligned} \int_{-1}^1 P_m(x)P_n(x)dx &= \frac{-1}{2^{m+n}m!n!} \int_{-1}^1 \frac{d^{m-1}}{dx^{m-1}} (x^2-1)^m \frac{d^{n+1}}{dx^{n+1}} (x^2-1)^n dx \\ &= \frac{(-1)^n}{2^{m+n}m!n!} \int_{-1}^1 \frac{d^{m-n}}{dx^{m-n}} (x^2-1)^m \frac{d^{2n}}{dx^{2n}} (x^2-1)^n dx \\ &= 0. \end{aligned}$$

Example 2. Shew that $\int_{-1}^1 P_n^2(x)dx = 2/(2n+1)$.

As in *Example 1* we have

$$\begin{aligned} \int_{-1}^1 P_n^2(x)dx &= \frac{(-1)^n}{2^{2n}(n!)^2} \int_{-1}^1 (x^2-1)^n \frac{d^{2n}}{dx^{2n}} (x^2-1)^n dx \\ &= \frac{(2n)!}{2^{2n}(n!)^2} \int_{-1}^1 (1-x^2)^n dx \\ &= \frac{2(2n)!}{(n!)^2} \int_0^1 \xi^n (1-\xi)^n d\xi, \text{ where } x=2\xi-1 \\ &= \frac{2(2n)!}{(n!)^2} B(n+1, n+1) = \frac{2}{2n+1}. \end{aligned}$$

Example 3. Shew that

$$z^n = A_n P_n(z) + A_{n-2} P_{n-2}(z) + A_{n-4} P_{n-4}(z) + \dots,$$

where

$$A_n = 2^n (n!)^2 / (2n)!.$$

Example 4. Shew that:

$$(i) \int_{-1}^1 z^m P_n(z) dz = 0, \text{ where } m < n;$$

$$(ii) \int_{-1}^1 z^n P_n(z) dz = \frac{2^{n+1}(n!)^2}{(2n+1)!}.$$

55. Analytical Continuation. If $f(z)$ is holomorphic in a region S , if $\phi(z)$ is holomorphic in a region S' , which includes S and if $\phi(z) = f(z)$ for all points of S , $\phi(z)$ is said to give the *Analytical Continuation* of $f(z)$ in the region S' .

For example, the function $f(z) = \sum_0^{\infty} z^n$ is holomorphic at all points within the circle $|z|=1$, the function $\phi(z) = 1/(1-z)$ is holomorphic except at $z=1$, and $\phi(z) = f(z)$ within $|z|=1$. Thus $\phi(z)$ gives the continuation of $f(z)$ over the rest of the plane.

Example. If $f(z) = \sum_1^{\infty} 1/z^n$, over what region is $f(z)$ holomorphic, and what function gives its analytical continuation? *Ans.* Outside $|z|=1$; $1/(z-1)$.

The following theorems are useful in determining the analytical continuations of functions.

THEOREM I. If a holomorphic function $f(z)$ and all its derivatives vanish at a point a , $f(z)$ and all its derivatives will vanish at all points in the domain of a .

For $f(z) = \sum_0^{\infty} c_n(z-a)^n$, where $c_n = f^{(n)}(a)/n!$, ($n=0, 1, 2, \dots$); thus $c_0 = c_1 = c_2 = \dots = 0$, and therefore $f(z)$, $f'(z)$, $f''(z)$, \dots , all vanish at all points of the domain.

COROLLARY. If two functions and all their derivatives are equal at a point a , and if they are both holomorphic in a circle of centre a , they are equal at all points of the circle.

For the differences of the two functions and of all their derivatives vanish at a .

THEOREM II. If $f(z)$ and all its derivatives vanish at a point of a connected region E in which $f(z)$ is holomorphic, $f(z)$ will vanish at all points of E .

Let A (Fig. 55) be the given point, and P any other point of E . Let a path AP in E join A and P , and let d be the shortest

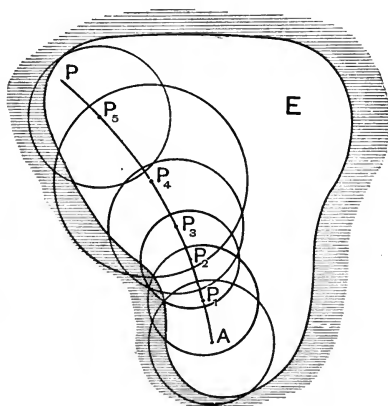

FIG. 55.

distance from any point on AP to the nearest singularity of $f(z)$; so that the domain of any point on AP must be at least of radius d . On AP take successive points A, P_1, P_2, P_3, \dots , such that each lies within the domain of the preceding point.

They can be selected so that, after a finite number of steps, a domain is reached which contains P . Then (Theorem I.) $f(z)$ and all its derivatives vanish at P_1, P_2, P_3, \dots , and therefore at P .

COROLLARY. If two functions and all their derivatives are equal at a point of a connected region in which they are holomorphic, they are equal at all points of the region.

THEOREM III. If two functions $f(z)$ and $\phi(z)$ are equal at all points of a line L in a region E in which they are both holomorphic, the functions are equal at all points of E .

For, if the points z_1 and z_2 lie on L ,

$$\lim_{z_2 \rightarrow z_1} \frac{f(z_2) - f(z_1)}{z_2 - z_1} = \lim_{z_2 \rightarrow z_1} \frac{\phi(z_2) - \phi(z_1)}{z_2 - z_1}.$$

Thus the first derivatives of $f(z)$ and $\phi(z)$ are equal at all points of L . Similarly all the other derivatives of $f(z)$ and $\phi(z)$ can be shewn to be equal at all points of L ; and therefore the functions are equal at all points of E .

This theorem is particularly important, as it enables us to extend theorems which have been proved for the real variable to complex values of the variable. For example, let

$$f(z) = \sin^2 z + \cos^2 z \quad \text{and} \quad \phi(z) = 1;$$

then, if we assume that the equation

$$\sin^2 x + \cos^2 x = 1, \quad \text{or} \quad f(x) = \phi(x),$$

has been established for x real, it follows, since $f(z)$ and $\phi(z)$ are holomorphic for all finite values of z , that $f(z) = \phi(z)$ for all finite values of z ; *i.e.* that $\sin^2 z + \cos^2 z = 1$.

Example 1. Prove $nP_n(z) = z \frac{dP_n(z)}{dz} - \frac{dP_{n-1}(z)}{dz}$.

Since the zeros of $1 - 2i\zeta + \zeta^2$ are $i(1 \pm \sqrt{2})$, the expansion

$$\frac{1}{\sqrt{(1 - 2i\zeta + \zeta^2)}} = \sum_0^\infty P_n(i)\zeta^n$$

is valid if $|\zeta| < \sqrt{2} - 1$. Hence the series of positive terms $\sum_0^\infty |P_n(i)|R^n$, where $R = 0.4 < \sqrt{2} - 1$, is convergent.

But, if $|z| \leq 1$, $|P_n(z)| \leq |P_n(i)|$, (§ 54, Corollary).

Thus the series $\frac{1}{\sqrt{(1 - 2z\zeta + \zeta^2)}} = \sum_0^\infty P_n(z)\zeta^n$

is uniformly convergent with regard to both z and ζ provided $|z| \leq 1, |\zeta| \leq R$.

Now differentiate with regard to z and ζ in turn; then

$$\frac{\zeta}{(1-2z\zeta+\zeta^2)^{3/2}} = \sum_0^\infty P_n'(z)\zeta^n, \quad \frac{z-\zeta}{(1-2z\zeta+\zeta^2)^{3/2}} = \sum_1^\infty nP_n(z)\zeta^{n-1};$$

so that

$$(z-\zeta)\sum_0^\infty P_n'(z)\zeta^n = \zeta\sum_1^\infty nP_n(z)\zeta^{n-1}.$$

Accordingly, if the coefficients of ζ^n are equated,

$$nP_n(z) = z \frac{dP_n(z)}{dz} - \frac{dP_{n-1}(z)}{dz}, \quad \text{where } |z| < 1.$$

But the functions on both sides of this equation are holomorphic for all values of the variable; therefore, for all values of z ,

$$nP_n(z) = z \frac{dP_n(z)}{dz} - \frac{dP_{n-1}(z)}{dz}.$$

Example 2. If $ze^{bz} = w$, shew that

$$e^{az} = 1 + aw + \frac{a(a-2b)}{2!} w^2 + \frac{a(a-3b)^2}{3!} w^3 + \dots,$$

provided $|w| < e^{-1}/|b|$.

[Apply Lagrange's expansion for $F(z) = e^{az}$. Since the series is convergent for $|w| < e^{-1}/|b|$, it follows, by the principle of analytical continuation, that the equation holds for that region.]

56. Abel's Theorem. A power series represents a continuous function at all points within its circle of convergence. If the series also converges at points on the circle of convergence, the following theorem shews that the region of continuity includes these points.

THEOREM. If the power series $\sum_0^\infty c_n z^n = \phi(z)$ be convergent at a point z_0 on its circle of convergence, and if z be a point within the circle,

$$\sum_0^\infty c_n z_0^n = \lim_{z \rightarrow z_0} \phi(z),$$

where z tends to z_0 along a radius.*

Let $z = \rho(\cos \theta + i \sin \theta)$: then

$$\begin{aligned} \sum_0^\infty c_n z^n &= \sum_0^\infty c_n \rho^n (\cos n\theta + i \sin n\theta) \\ &= \sum_0^\infty c_n \rho_0^n x^n \cos n\theta + i \sum_0^\infty c_n \rho_0^n x^n \sin n\theta, \end{aligned}$$

where $x = \rho/\rho_0$.

Hence it is only necessary to prove that if the series $\sum_0^\infty a_n$, where

$$a_n = c_n \rho_0^n \cos n\theta \quad \text{or} \quad c_n \rho_0^n \sin n\theta,$$

is convergent, the function $\sum_0^\infty a_n x^n$ will be continuous for $0 \leq x \leq 1$.

* Cf. Bromwich, *Infinite Series*, § 83.

Now let $r_{n,p} = a_{n+1} + a_{n+2} + \dots + a_{n+p}$.

Then for any particular value of n , finite quantities H and h can be found such that $H > r_{n,p} > h$, where p is any positive integer. Hence

$$\begin{aligned} & a_{n+1}x^{n+1} + a_{n+2}x^{n+2} + \dots + a_{n+p}x^{n+p} \\ &= r_{n,1}x^{n+1} + (r_{n,2} - r_{n,1})x^{n+2} + \dots + (r_{n,p} - r_{n,p-1})x^{n+p} \\ &= r_{n,1}(x^{n+1} - x^{n+2}) + r_{n,2}(x^{n+2} - x^{n+3}) + \dots \\ &\quad + r_{n,p-1}(x^{n+p-1} - x^{n+p}) + r_{n,p}x^{n+p} \\ &\leq H(x^{n+1} - x^{n+2} + x^{n+2} - x^{n+3} + \dots + x^{n+p-1} - x^{n+p} + x^{n+p}), \end{aligned}$$

if $0 \leq x \leq 1$,

$$\leq Hx^{n+1} \leq H.$$

Similarly, $a_{n+1}x^{n+1} + a_{n+2}x^{n+2} + \dots + a_{n+p}x^{n+p} > h$.

But an m can always be found such that $|H| < \epsilon$ and $|h| < \epsilon$ for $n \geq m$; so that $|a_{n+1}x^{n+1} + a_{n+2}x^{n+2} + \dots + a_{n+p}x^{n+p}| < \epsilon$.

Hence the series converges uniformly for $0 \leq x \leq 1$. Consequently the theorem is proved.

COROLLARY. If the series converges at all points of an arc of the circle of convergence, $\phi(z)$ will be continuous on that arc.

Example 1. Consider the function

$$\log(1+z) = \int_0^z \frac{dz}{1+z},$$

rendered uniform by a crosscut along the negative real axis from -1 to $-\infty$.

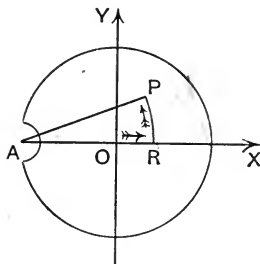

FIG. 56.

Let A and P be the points -1 and z respectively, and let the circle of centre A and radius AP cut OX in R (Fig. 56). Let the integral be taken along the path ORP : then

$$\begin{aligned} \log(1+z) &= \int_0^z \frac{dz}{1+z} = \log \frac{\overline{AR}}{\overline{AO}} + \log \frac{\overline{AP}}{\overline{AR}} \\ &= \log AR + i\phi \end{aligned}$$

where ϕ denotes $\angle OAP$.

Now, if $|z| < 1$, $\log(1+z) = z - z^2/2 + z^3/3 - \dots$,

and this series converges at all points of the circle $|z|=1$ except A, (Abel's Test, § 38). Thus it represents the continuous function $\log(1+z)$ in the region of Fig. 56, bounded by the circle $|z|=1$ indented at A. Accordingly, if P is the point $z = e^{i\theta}$, where $-\pi < \theta < \pi$,

$$\log(1+z) = \log\left(2 \cos \frac{\theta}{2}\right) + i \frac{\theta}{2} = e^{i\theta} - \frac{e^{2i\theta}}{2} + \frac{e^{3i\theta}}{3} - \dots;$$

so that, if real and imaginary parts be equated,

$$\left. \begin{aligned} \cos \theta - \frac{\cos 2\theta}{2} + \frac{\cos 3\theta}{3} - \dots &= \log\left(2 \cos \frac{\theta}{2}\right) \\ \sin \theta - \frac{\sin 2\theta}{2} + \frac{\sin 3\theta}{3} - \dots &= \frac{\theta}{2} \end{aligned} \right\} -\pi < \theta < \pi.$$

Note. $\theta=0$ in the first equation gives $\log 2 = 1 - 1/2 + 1/3 - \dots$

The two series

$$c_1 \cos \theta + c_2 \cos 2\theta + \dots, \text{ and } c_1 \sin \theta + c_2 \sin 2\theta + \dots$$

of § 38 are uniformly convergent in the interval $\epsilon \leq \theta \leq 2\pi - \epsilon$, since

$$|S_{m,p}| \leq \frac{c_{m+1}}{|\sin \frac{1}{2}\theta|} \leq \frac{c_{m+1}}{\sin \frac{1}{2}\epsilon}.$$

They can therefore be integrated term by term.

Example 2. If $-\pi \leq \theta \leq \pi$, prove

$$\cos \theta - \frac{\cos 2\theta}{2^2} + \frac{\cos 3\theta}{3^2} - \dots = \frac{\pi^2}{12} - \frac{\theta^2}{4}.$$

Example 3. If A, B, P (Fig. 57) are the points i , $-i$, and z respectively shew that, for all points of the region bounded by the circle $|z|=1$ indented at A and B,

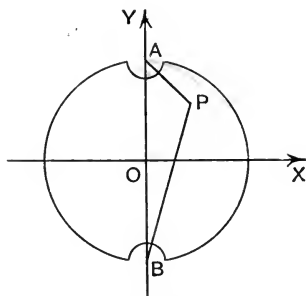

FIG. 57.

$$\int_0^z \frac{dz}{1+z^2} = z - \frac{z^3}{3} + \frac{z^5}{5} - \dots = \begin{cases} \frac{1}{2i} \log \frac{AP}{BP} + \frac{1}{2}(\pi - \angle APB), & \text{if } -\frac{\pi}{2} < \text{amp } z < \frac{\pi}{2}; \\ \frac{1}{2i} \log \frac{AP}{BP} - \frac{1}{2}(\pi - \angle BPA), & \text{if } \frac{\pi}{2} < \text{amp } z < \frac{3\pi}{2}. \end{cases}$$

Deduce

$$(i) \cos \theta - \frac{\cos 3\theta}{3} + \frac{\cos 5\theta}{5} - \dots = \begin{cases} \pi/4, & \text{if } \cos \theta \text{ is positive;} \\ 0, & \text{if } \cos \theta = 0; \\ -\pi/4, & \text{if } \cos \theta \text{ is negative;} \end{cases}$$

$$(ii) \sin \theta - \frac{\sin 3\theta}{3} + \frac{\sin 5\theta}{5} - \dots = \begin{cases} \frac{1}{2} \log \cot \left(\frac{\pi - \theta}{4} - \frac{\theta}{2} \right), & \text{if } -\frac{\pi}{2} < \theta < \frac{\pi}{2}; \\ \frac{1}{2} \log \cot \left(\frac{\theta}{2} - \frac{\pi}{4} \right), & \text{if } \frac{\pi}{2} < \theta < \frac{3\pi}{2}. \end{cases}$$

EXAMPLES VII.

1. Integrate $\frac{1}{z} \left(\frac{1}{1+z} - e^{-z} \right)$ round the contour of Fig. 52, and shew that :

$$(i) \int_0^{\infty} \left(\frac{1}{1+x^2} - \cos x \right) \frac{dx}{x} = \int_0^{\infty} \left(\frac{1}{1+x} - e^{-x} \right) \frac{dx}{x}; \quad (ii) \int_0^{\infty} \frac{\sin x}{x} dx = \frac{\pi}{2}.$$

2. Prove $\tan z = 2 \sum_1^{\infty} \frac{z}{(n-1/2)^2 \pi^2 - z^2}$.

3. Prove $\sec z = \sum_1^{\infty} (-1)^{n+1} \frac{(2n-1)\pi}{(n-1/2)^2 \pi^2 - z^2}$.

4. Prove $\frac{1}{e^z - 1} = -\frac{1}{z} + \sum_1^{\infty} \frac{2z}{z^2 + 4n^2 \pi^2}$.

5. If $-\pi \leq r \leq \pi$, shew that :

$$(i) \frac{\pi}{2z} \frac{e^{rz} + e^{-rz}}{e^{\pi z} - e^{-\pi z}} = \frac{1}{2} \frac{1}{z^2} - \frac{\cos r}{z^2 + 1} + \frac{\cos 2r}{z^2 + 4} - \frac{\cos 3r}{z^2 + 9} + \dots;$$

$$(ii) \frac{\pi}{2z} \frac{\cos rz}{\sin \pi z} = \frac{1}{2} \frac{1}{z^2} - \frac{\cos r}{z^2 - 1} + \frac{\cos 2r}{z^2 - 4} - \frac{\cos 3r}{z^2 - 9} + \dots$$

6. If $-\pi < r < \pi$, shew that :

$$(i) \frac{\pi}{2} \frac{e^{rz} - e^{-rz}}{e^{\pi z} - e^{-\pi z}} = + \frac{\sin r}{z^2 + 1} - \frac{2 \sin 2r}{z^2 + 4} + \frac{3 \sin 3r}{z^2 + 9} - \dots;$$

$$(ii) \frac{\pi}{2} \frac{\sin rz}{\sin \pi z} = - \frac{\sin r}{z^2 - 1} + \frac{2 \sin 2r}{z^2 - 4} - \frac{3 \sin 3r}{z^2 - 9} + \dots$$

7. Shew that $P \int_0^{\infty} \tan x \frac{dx}{x} = \frac{\pi}{2}$.

8. If $-b < a < b$, shew that

$$(i) P \int_0^{\infty} \frac{\sin ax}{\sin bx} \frac{dx}{1+x^2} = \frac{\pi}{2} \frac{\sinh a}{\sinh b};$$

$$(ii) P \int_0^{\infty} \frac{\cos ax}{\sin bx} \frac{x dx}{1+x^2} = \frac{\pi}{2} \frac{\cosh a}{\sinh b};$$

$$(iii) P \int_0^{\infty} \frac{\sin ax}{\cos bx} \frac{dx}{x(1+x^2)} = \frac{\pi}{2} \frac{\sinh a}{\cosh b};$$

$$(iv) P \int_0^{\infty} \frac{\cos ax}{\cos bx} \frac{dx}{1+x^2} = \frac{\pi}{2} \frac{\cosh a}{\cosh b};$$

$$(v) P \int_0^{\infty} \frac{\sin ax}{\cos bx} \frac{x dx}{1+x^2} = - \frac{\pi}{2} \frac{\sinh a}{\cosh b}.$$

9. If $m > 0$, prove

$$\int_0^\infty \cos 4mx \tanh x \frac{dx}{x} = \log(\coth m\pi).$$

10. If a and b are real, and $-\pi < b < \pi$, prove

$$\int_0^\infty \frac{\cosh bx}{\cosh \pi x} \cos ax \, dx = \frac{\cosh(a/2)\cos(b/2)}{\cosh a + \cos b}.$$

11. Prove $\sum_{n=0}^\infty \frac{1}{a+bn^2} = \frac{1}{2a} + \frac{\pi}{2\sqrt{ab}} \coth\left(\pi\sqrt{\frac{a}{b}}\right)$.

12. Shew that, if m is a positive integer, the root of $z = \zeta + wz^{m+1}$ which has the value ζ when $w=0$ is given by

$$z = \zeta + w\zeta^{m+1} + \frac{2m+2}{2!} w^2 \zeta^{2m+1} + \dots + \frac{(nm+2)(nm+3)\dots(nm+n)}{n!} w^n \zeta^{nm+1} + \dots,$$

provided $|w| < m^m(m+1)^{-m-1} |\zeta|^{-m}$.

13. Prove that the coefficient of z^{n-1} in the expansion of $\{z/(e^z-1)\}^n$ is $(-1)^{n-1}$. [Use Lagrange's Expansion for $w = e^z - 1$.]

14. Prove that the coefficient of z^{n-1} in the expansion of $(1+z)^{2n-1}(2+z)^{-n}$ is $1/2$. [Use Lagrange's Expansion for $w = z(2+z)/(1+z)^2$, $F(z) = \log(1+z)$.]

15. If m and n are distinct positive integers, shew that

$$\int_{-1}^1 (1-x^2) \frac{dP_m(x)}{dx} \frac{dP_n(x)}{dx} dx = 0.$$

16. Prove $\int_{-1}^1 (1-x^2) \left\{ \frac{dP_n(x)}{dx} \right\}^2 dx = \frac{2n(n+1)}{2n+1}$.

17. Prove $\int_{-1}^1 x^2 P_{n+1}(x) P_{n-1}(x) dx = \frac{2n(n+1)}{(2n-1)(2n+1)(2n+3)}$.

18. Prove $\int_{-1}^1 x^2 P_n^2(x) dx = \frac{1}{8(2n-1)} + \frac{3}{4(2n+1)} + \frac{1}{8(2n+3)}$.

19. Shew that $\frac{dP_n(z)}{dz} - \frac{dP_{n-2}(z)}{dz} = (2n-1)P_{n-1}(z)$.

20. If $|w| < 1/4$, shew that

$$(1-z)^k = 1 - kw + \frac{k(k-3)}{2!} w^2 - \frac{k(k-4)(k-5)}{3!} w^3 + \dots,$$

where $w = z(1-z)$.

21. If $|w| < e^{-1}$, shew that

$$z = 1 + w + 3 \frac{w}{2!} + 4^2 \frac{w^3}{3!} + 5^3 \frac{w^4}{4!} + \dots,$$

where z is that root of $\log z = wz$ which has the value $+1$ when $w=0$.

[In Ex. 2, § 55, put $a=1$, $b=-1$, $z = \log \zeta$]

22. If n is a positive integer, shew that

$$(z+a)^n = z^n + na(z+b)^{n-1} + \dots + {}^n C_r a(a-rb)^{r-1} (z+rb)^{n-r} + \dots + a(a-nb)^{n-1}.$$

[In Ex. 2, § 55, multiply by $e^{\zeta z}$, and equate the coefficients of z^n .]

23. If θ is real and $|\theta| < e^{-1}$, shew that :

$$(i) \cos \theta = 1 - \theta \sin \theta + \frac{1}{2!} \theta^2 \cos 2\theta + \frac{2^2}{3!} \theta^3 \sin 3\theta - \frac{3^3}{4!} \theta^4 \cos 4\theta - \dots;$$

$$(ii) \sin \theta = \theta \cos \theta + \frac{1}{2!} \theta^2 \sin 2\theta - \frac{2^2}{3!} \theta^3 \cos 3\theta + \frac{3^3}{4!} \theta^4 \sin 4\theta + \dots$$

[In Ex. 2, § 55, put $a=b=i$.]

24. Prove that, for all points within and on the circle $|z|=1$,

$$(1+z) \log(1+z) - z = \frac{z^2}{1 \cdot 2} - \frac{z^3}{2 \cdot 3} + \frac{z^4}{3 \cdot 4} - \dots;$$

and deduce that

$$\left. \begin{aligned} (i) & \frac{\cos 2\theta}{1 \cdot 2} - \frac{\cos 3\theta}{2 \cdot 3} + \frac{\cos 4\theta}{3 \cdot 4} - \dots \\ & = (1 + \cos \theta) \log \left(2 \cos \frac{\theta}{2} \right) - \cos \theta - \frac{\theta}{2} \sin \theta; \\ (ii) & \frac{\sin 2\theta}{1 \cdot 2} - \frac{\sin 3\theta}{2 \cdot 3} + \frac{\sin 4\theta}{3 \cdot 4} - \dots \\ & = \sin \theta \log \left(2 \cos \frac{\theta}{2} \right) - \sin \theta + \frac{\theta}{2} (1 + \cos \theta). \end{aligned} \right\} -\pi \leq \theta \leq \pi.$$

25. Prove
$$\int_0^{\infty} \frac{dx}{(1+x^2) \cosh \frac{1}{2}\pi x} = \log 2.$$

[Integrate $\frac{1}{(1+z^2) \cosh \frac{1}{2}\pi z}$ round the contour of Fig. 33, and use Ex. 1 § 56.]

26. If $-1/2 < m < 1/2$, shew that

$$\int_0^{\infty} \frac{\sinh^2 mx}{x \sinh x} dx = \frac{1}{2} \log \sec m\pi.$$

27. Shew that, if $0 < \text{amp } z < 2\pi$,

$$\log(1-z) = \log(1+e^{-i\pi z}) = -z - \frac{z^2}{2} - \frac{z^3}{3} - \dots$$

Deduce :

$$\left. \begin{aligned} (i) \cos \theta + \frac{\cos 2\theta}{2} + \frac{\cos 3\theta}{3} + \dots &= -\log \left(2 \sin \frac{\theta}{2} \right); \\ (ii) \sin \theta + \frac{\sin 2\theta}{2} + \frac{\sin 3\theta}{3} + \dots &= \frac{\pi - \theta}{2}; \end{aligned} \right\} 0 < \theta < 2\pi.$$

Graph the functions represented by these two series for all values of θ .

28. Shew that

$$\sin \theta + \frac{\sin 3\theta}{3} + \frac{\sin 5\theta}{5} + \dots = \begin{cases} \pi/4, & \text{if } \sin \theta > 0. \\ 0, & \text{if } \sin \theta = 0. \\ -\pi/4, & \text{if } \sin \theta < 0. \end{cases}$$

29. Shew that

$$\sin \theta - \frac{\sin 3\theta}{3^2} + \frac{\sin 5\theta}{5^2} - \dots = \begin{cases} \frac{\pi}{4} \theta, & \text{if } -\frac{\pi}{2} \leq \theta \leq \frac{\pi}{2}. \\ \frac{\pi}{4} (\pi - \theta), & \text{if } \frac{\pi}{2} \leq \theta \leq \frac{3\pi}{2}. \end{cases}$$

30. Shew that, if $-\pi/3 < \theta < \pi/3$,

$$\cos \theta - \frac{\cos 5\theta}{5} + \frac{\cos 7\theta}{7} - \frac{\cos 11\theta}{11} + \dots = \frac{\pi}{6} \sqrt{3}.$$

31. Shew that the locus represented by

$$\sum_{n=1}^{\infty} \frac{(-1)^{n-1}}{n^2} \sin nx \sin ny = 0$$

consists of two orthogonal systems of straight lines dividing the (x, y) plane into squares of area π^2 .

32. Shew that the equation

$$\sum_{n=1}^{\infty} \frac{(-1)^{n-1}}{n^3} \sin ny \cos nx = 0$$

represents the lines $y = m\pi$, ($m=0, \pm 1, \pm 2, \dots$), together with a series of arcs of ellipses whose axes are of lengths π and $\pi/\sqrt{3}$, placed in squares of area π^2 . Draw a diagram of the locus.

33. If $f(x, y, z) = \sum_{n=1}^{\infty} \frac{(-1)^{n-1}}{n^3} \sin nx \sin ny \sin nz$,

shew that, within the octahedron bounded by the planes $\pm x \pm y \pm z = \pi$, $f(x, y, z) = xyz/2$.

34. If $\frac{\pi r}{2a} = 6 - 3\sqrt{3} + 2 \sum_{n=1}^{\infty} \frac{6(-1)^{n-1} + 3\sqrt{3}}{(6n-1)(6n+1)} \cos 6n\theta$,

shew that, for $0 < \theta < \pi/6$, $r = 2a \cos(\theta + \pi/3)$.

Graph the curve for values of θ between 0 and 2π .

35. If $w = z(1+z^2)$, and the principal value of $\tan^{-1}z$ is taken, prove that

$$\tan^{-1}z = w - \frac{4}{1!} \frac{w^3}{3} + \frac{6 \cdot 7}{2!} \frac{w^5}{5} - \frac{8 \cdot 9 \cdot 10}{3!} \frac{w^7}{7} + \dots,$$

provided $|w| < \frac{2}{3}\sqrt{3}$.

36. Shew that the two functions $4z \pm \tan z$ each possess only one zero within the unit circle.

CHAPTER VIII.

GAMMA FUNCTIONS.

57. The Bernoulli Numbers. The Bernoulli Numbers B_1, B_2, B_3, \dots , are defined by the expansion

$$\frac{z}{e^z - 1} = 1 - \frac{z}{2} + \sum_1^{\infty} (-1)^{n-1} \frac{B_n}{(2n)!} z^{2n}$$

considered in § 44. Their numerical values can be found by the method established there; thus

$$B_1 = \frac{1}{6}, \quad B_2 = \frac{1}{30}, \quad B_3 = \frac{1}{42}, \quad \dots$$

From the expansion it follows that $(-1)^{n-1} B_n / (2n)!$ is the residue of $1 / \{z^{2n}(e^z - 1)\}$ at $z = 0$. But (Theorem II, § 51)

$$\lim_{\nu \rightarrow \infty} \int_{c_\nu} \frac{dz}{z^{2\nu}(e^z - 1)} = 0,$$

where c_ν denotes the circle $|z| = (2\nu + 1)\pi$. Therefore

$$(-1)^n \frac{B_n}{(2n)!} = \sum'_{r=-\infty}^{\infty} \frac{1}{(2r\pi i)^{2n}} = (-1)^n \sum_{r=1}^{\infty} \frac{2}{(2r\pi)^{2n}};$$

so that

$$B_n = 2 \frac{(2n)!}{(2\pi)^{2n}} \sum_{r=1}^{\infty} \frac{1}{r^{2n}}.$$

Example. Shew that $\frac{1}{1^2} + \frac{1}{2^2} + \frac{1}{3^2} + \dots = \frac{\pi^2}{6}$.

The Bernoulli Numbers as Definite Integrals. If α is positive,

$$S_n = e^{-\alpha} + e^{-2\alpha} + \dots + e^{-n\alpha} = \frac{1}{2\pi i} \int_C \pi \cot(\pi z) \cdot e^{-\alpha z} dz, \quad (\S 52)$$

where C denotes the rectangle $ABCD$ (Fig. 58) of sides $x = 0$, $x = b = n + 1/2$, $y = \pm R$, indented at O .

The integral of $(1/2i) \cot(\pi z) \cdot e^{-\alpha z}$ along the small semi-circle tends to $-\frac{1}{2}$, (§ 30, Th. 2). On the contours $ECDF$ and $GABE$ replace $(1/2i) \cot(\pi z)$ by

$$-\frac{1}{2} - \frac{1}{e^{-2\pi iz} - 1} \quad \text{and} \quad \frac{1}{2} + \frac{1}{e^{2\pi iz} - 1}$$

respectively. The integrals arising from the terms $-\frac{1}{2}$ and $+\frac{1}{2}$ tend to

$$-\frac{1}{2} \int_{ECDO} e^{-az} dz \quad \text{and} \quad \frac{1}{2} \int_{OABE} e^{-az} dz$$

respectively. But, since e^{-az} is holomorphic in the rectangle, each of these integrals is equal to

$$\frac{1}{2} \int_0^b e^{-ax} dx.$$

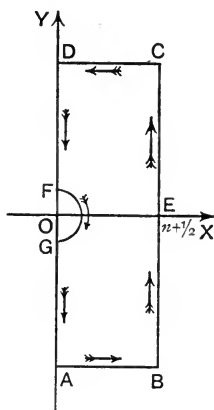

FIG. 58.

Thus we find

$$S_n = \int_0^b e^{-ax} dx - \frac{1}{2} + \int_0^R \left(\frac{e^{-ia y}}{e^{2\pi y} - 1} - \frac{e^{ia y}}{e^{2\pi y} - 1} \right) i dy - I_1 + I_2,$$

where
$$I_1 = \int_0^R \left\{ \frac{e^{-\alpha(b+iy)}}{e^{-2\pi i(b+iy)} - 1} - \frac{e^{-\alpha(b-iy)}}{e^{2\pi i(b-iy)} - 1} \right\} i dy,$$

and
$$I_2 = \int_0^b \left\{ \frac{e^{-\alpha(x+iR)}}{e^{-2\pi i(x+iR)} - 1} + \frac{e^{-\alpha(x-iR)}}{e^{2\pi i(x-iR)} - 1} \right\} dx.$$

Now
$$I_1 = -2e^{-\alpha(n+1/2)} \int_0^R \frac{\sin \alpha y}{e^{2\pi y} + 1} dy;$$

so that
$$|I_1| < 2e^{-\alpha(n+1/2)} \int_0^R e^{-2\pi y} dy = \frac{1}{\pi} e^{-\alpha(n+1/2)} (1 - e^{-2\pi R})$$

$$< \frac{1}{\pi} e^{-\alpha(n+1/2)}.$$

Hence

$$\lim_{n \rightarrow \infty} I_1 = 0.$$

$$\text{Again, } |I_2| < \frac{2}{e^{2\pi R} - 1} \int_0^b e^{-\alpha x} dx = \frac{2}{\alpha(e^{2\pi R} - 1)} (1 - e^{-\alpha b})$$

$$< \frac{2}{\alpha(e^{2\pi R} - 1)}.$$

Hence $\lim_{R \rightarrow \infty} I_2 = 0.$

$$\text{Accordingly } \sum_1^{\infty} e^{-n\alpha} = \frac{1}{\alpha} - \frac{1}{2} + \int_0^{\infty} \frac{2 \sin \alpha y}{e^{2\pi y} - 1} dy.$$

$$\text{But } \sum_1^{\infty} e^{-n\alpha} = \frac{1}{e^{\alpha} - 1} = \frac{1}{\alpha} - \frac{1}{2} + \sum_1^{\infty} (-1)^{n-1} \frac{B_n}{(2n)!} \alpha^{2n-1}$$

Hence, expanding $\sin \alpha y$ in powers of α (cf. Bromwich, *Inf. Ser.*, § 176, B), and equating coefficients, we have

$$B_n = 4n \int_0^{\infty} \frac{y^{2n-1} dy}{e^{2\pi y} - 1} = \frac{2n(2n-1)}{\pi} \int_0^{\infty} y^{2n-2} \log \left(\frac{1}{1 - e^{-2\pi y}} \right) dy.$$

Example. Prove $\int_0^{\infty} \frac{x^2 dx}{\sinh^2 x} = \frac{\pi^2}{6}.$

58. The Asymptotic Expansion of Euler's Constant. Let

$$S_n = 1 + \frac{1}{2} + \dots + \frac{1}{n} = \frac{1}{2\pi i} \int_C \pi \cot \pi z \frac{dz}{z}, \quad (\S 52)$$

where C is the rectangle ABCD (Fig. 59) of sides $x=1$, $x=n$, $y=\pm R$, with small semi-circles at 1 and n .

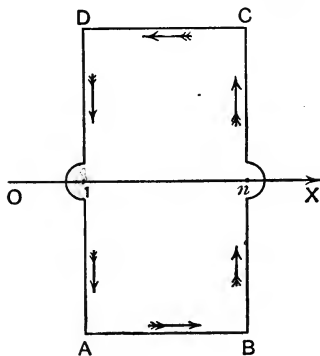

FIG. 59.

The integrals of $(1/2i) \cot(\pi z) \cdot z^{-1}$ along the small semi-circles at $z=1$ and $z=n$ tend to $\frac{1}{2}$ and $1/(2n)$ respectively (§ 30, Th. 2). On the remaining portions of C , replace $(1/2i) \cot(\pi z)$ by

$$-\frac{1}{2} - \frac{1}{e^{-2\pi iz} - 1} \quad \text{or} \quad \frac{1}{2} + \frac{1}{e^{2\pi iz} - 1},$$

according as z lies above or below the x -axis. The integrals arising from the terms $-\frac{1}{2}$ and $+\frac{1}{2}$ each tend to

$$\frac{1}{2} \int_1^n \frac{dx}{x}.$$

Thus we find

$$S_n = \frac{1}{2} + \frac{1}{2n} + \int_1^n \frac{dx}{x} + \int_0^R \frac{2y}{1+y^2} \frac{dy}{e^{2\pi y} - 1} - \int_0^R \frac{2y}{n^2+y^2} \frac{dy}{e^{2\pi y} - 1} + I,$$

where
$$I = \int_1^n \frac{1}{e^{-2\pi i(x+iR)} - 1} \frac{dx}{x+iR} + \int_1^n \frac{1}{e^{2\pi i(x-iR)} - 1} \frac{dx}{x-iR}.$$

Now,
$$|I| < \frac{2}{e^{2\pi R} - 1} \int_1^n \frac{dx}{\sqrt{(x^2+R^2)}} < \frac{2(n-1)}{R(e^{2\pi R} - 1)},$$

so that

$$\lim_{R \rightarrow \infty} I = 0.$$

Hence

$$S_n = \log n + \frac{1}{2} + \frac{1}{2n} + \int_0^\infty \frac{2y}{1+y^2} \frac{dy}{e^{2\pi y} - 1} - \int_0^\infty \frac{2y}{n^2+y^2} \frac{dy}{e^{2\pi y} - 1}.$$

But
$$\int_0^\infty \frac{2y}{n^2+y^2} \frac{dy}{e^{2\pi y} - 1} < \frac{1}{n^2} \int_0^\infty \frac{2y}{e^{2\pi y} - 1} dy;$$

therefore, as n tends to infinity, $S_n - \log n$ tends to the limit

$$\frac{1}{2} + \int_0^\infty \frac{2y}{1+y^2} \frac{dy}{e^{2\pi y} - 1}.$$

This limit is *Euler's Constant*, and is denoted by γ . Thus

$$\begin{aligned} \gamma &= S_n - \log n - \frac{1}{2n} + \int_0^\infty \frac{2y}{n^2+y^2} \frac{dy}{e^{2\pi y} - 1} \\ &= S_n - \log n - \frac{1}{2n} + \int_0^\infty \left\{ \frac{1}{n^2} - \frac{y^2}{n^4} + \frac{y^4}{n^6} - \dots + (-1)^{k-1} \frac{y^{2k-2}}{n^{2k}} \right. \\ &\quad \left. + (-1)^k \frac{y^{2k}}{n^{2k}(n^2+y^2)} \right\} \frac{2y}{e^{2\pi y} - 1} dy \\ &= S_n - \log n - \frac{1}{2n} + \frac{B_1}{2n^2} - \frac{B_2}{4n^4} + \frac{B_3}{6n^6} - \dots \\ &\quad + (-1)^{k-1} \frac{B_k}{2kn^{2k}} + (-1)^k R_k, \end{aligned}$$

where

$$R_k = \int_0^\infty \frac{2y^{2k+1}}{n^{2k}(n^2+y^2)} \frac{dy}{e^{2\pi y} - 1} < \frac{1}{n^{2k+2}} \int_0^\infty \frac{2y^{2k+1}}{e^{2\pi y} - 1} dy = \frac{B_{k+1}}{(2k+2)n^{2k+2}}.$$

$$\text{Now, } \frac{B_{k+1}}{B_k} = \frac{(2k+1)(2k+2)}{4\pi^2} \frac{\sum_{r=1}^{\infty} 1/\gamma^{2k+2}}{\sum_{r=1}^{\infty} 1/\gamma^{2k}};$$

but $\sum_{r=1}^{\infty} 1/\gamma^{2k} \leq \sum_{r=1}^{\infty} 1/\gamma^2 = \pi^2/6$ and $\sum_{r=1}^{\infty} 1/\gamma^{2k+2} > 1$, so that

$$\frac{B_{k+1}}{B_k} > \frac{3}{2\pi^4} (2k+1)(2k+2).$$

Thus the infinite series $\sum_{k=1}^{\infty} (-1)^{k-1} \frac{B_k}{2kn^{2k}}$ is divergent.

Nevertheless, if sufficiently large values of n are taken, the sum of a few (say k) terms will give the value of γ to any approximation required. For R_k can be made arbitrarily small by increasing n . An expansion such as this, consisting of a finite number of terms and a remainder which can be made arbitrarily small by sufficiently increasing the variable, is called an *Asymptotic Expansion*.

Example. If $n=10$ and $k=2$, shew that $R_k < .000000004$.

59. Convergent Integrals. In our definition of an integral we assumed that the path of integration did not pass through a singularity of the integrand $f(z)$. It is sometimes possible, however, to extend the definition to include cases in which an extremity z_1 of the path is a singularity of $f(z)$.

Let z' be a point on the path of integration; then, if the integral $\int_{z_0}^{z'} f(z) dz$ tends to a definite value as z' tends to z_1 , this limit is taken as the value of $\int_{z_0}^{z_1} f(z) dz$, and the integral is said to be convergent. The necessary and sufficient condition for this is that $\int_{z'}^{z''} f(z) dz$ should tend to zero as z' and z'' tend to z_1 .

The following two rules are useful for determining the convergence of integrals.

RULE I. Let z_1 be a finite point; then if a number $n < 1$ can be found such that $(z - z_1)^n f(z)$ tends to a definite limit L as z tends to z_1 , the integral $\int_{z_0}^{z_1} f(z) dz$ will be convergent.

For if z' be chosen so that $|(z-z_1)^n f(z) - L| < \epsilon$, provided $|z-z_1| \leq k$, where $k = |z' - z_1|$,

$$\left| \int_{z'}^{z''} f(z) dz \right| < \int_0^k \frac{|L| + \epsilon}{\rho^n} d\rho, \text{ where } \rho = |z - z_1|$$

$$< \frac{|L| + \epsilon}{1-n} k^{1-n};$$

and this quantity can be made arbitrarily small by decreasing k .

Example. Shew that the integral $\int_{z_1}^{z_2} \frac{dz}{\sqrt{\{(z-z_1)(z-z_2)\}}}$ is convergent.

RULE II. Let the point z_1 be at infinity; then if a number $n > 1$ can be found such that $z^n f(z)$ tends to a definite limit L as z tends to infinity along the path of integration, the integral will be convergent.

For if z' be chosen so that, for points z on the path of integration between z' and infinity, $|z^n f(z) - L| < \epsilon$,

$$\left| \int_{z'}^{z''} f(z) dz \right| < \int_K^{\infty} \frac{|L| + \epsilon}{\rho^n} d\rho, \text{ where } \rho = |z|, K = |z'|$$

$$< \frac{|L| + \epsilon}{(n-1)K^{n-1}},$$

and this quantity can be made arbitrarily small by increasing K .

Example. Shew that the integral $\int_0^{\infty} e^{-z} z^n dz$, taken along a straight line making an angle ϕ with the x -axis, converges if $-\pi/2 < \phi < \pi/2$, and $n > -1$.

60. Uniformly Convergent Integrals. Consider the integral $\int_C f(z, \xi) dz$, where $f(z, \xi)$ is holomorphic with regard to both z and ξ at all points of a region A in the z -plane which contains the curve C and at all points of a region A' in the ξ -plane, except for a singularity at the (upper) extremity z_1 of C .* Let z' be a point on C , and let C_1 be that part of C which has z' as its (upper) extremity. Then if, for all points ξ of A' , $\int_{C_1} f(z, \xi) dz$ tends uniformly to the limit $\phi(\xi)$ as z' tends to z_1 , the integral is said to be uniformly convergent in A' .

* It is assumed that the path C is independent of ξ .

THEOREM. If $\int_C f(z, \xi) dz$ is uniformly convergent in A' , it is a holomorphic function of ξ at all interior points of A' , and

$$\frac{d^n}{d\xi^n} \int_C f(z, \xi) dz = \int_C \frac{\partial^n}{\partial \xi^n} f(z, \xi) dz, \quad (n=1, 2, 3, \dots).$$

Let z' be chosen so that, for all points ξ in A' , $|\eta| < \epsilon$, where

$$\phi(\xi) = \psi(\xi) + \eta \quad \text{and} \quad \psi(\xi) = \int_{C_1} f(z, \xi) dz.$$

Then $\phi(\xi)$ is continuous in A' , since $\psi(\xi)$ is continuous (§34) and $|\eta| < \epsilon$.

Again, let ξ' be any interior point of A' , and let K be the boundary of a simply-connected portion of A' of which ξ' is an interior point. Then

$$\int_K \frac{\phi(\xi) d\xi}{(\xi - \xi')^{n+1}} = \int_K \frac{\psi(\xi) d\xi}{(\xi - \xi')^{n+1}} + \int_K \frac{\eta d\xi}{(\xi - \xi')^{n+1}};$$

so that $\left| \int_K \frac{\phi(\xi) d\xi}{(\xi - \xi')^{n+1}} - \frac{2\pi i}{n!} \psi^{(n)}(\xi') \right| \leq \frac{\epsilon L}{d^{n+1}}, \quad (n=0, 1, 2, \dots),$

where d is the shortest distance from ξ' to K , and L is the length of K .

Hence $\int_{C_1} \frac{\partial^n}{\partial \xi'^n} f(z, \xi') dz$ or $\psi^{(n)}(\xi')$

converges to the limit $\frac{n!}{2\pi i} \int_K \frac{\phi(\xi) d\xi}{(\xi - \xi')^{n+1}}$ as z' tends to z_1 ; and therefore

$$\int_C \frac{\partial^n}{\partial \xi'^n} f(z, \xi') dz = \frac{n!}{2\pi i} \int_K \frac{\phi(\xi) d\xi}{(\xi - \xi')^{n+1}}.$$

In particular, if $n=0$, $\int_{C_1} f(z, \xi') dz$ converges to the limit

$\frac{1}{2\pi i} \int_K \frac{\phi(\xi) d\xi}{\xi - \xi'}$, so that $\phi(\xi') = \frac{1}{2\pi i} \int_K \frac{\phi(\xi) d\xi}{\xi - \xi'}$. Now this integral is holomorphic (§35, Corollary 2) at ξ' . Hence $\phi(\xi)$ is holomorphic at ξ' , and has the derivatives

$$\phi^{(n)}(\xi') = \frac{n!}{2\pi i} \int_K \frac{\phi(\xi) d\xi}{(\xi - \xi')^{n+1}} = \int_C \frac{\partial^n}{\partial \xi'^n} f(z, \xi') dz.$$

Example 1. Integration under the Integral Sign.

If C' is any path in A' , $\int_{C'} \phi(\xi) d\xi = \int_C \int_{C'} f(z, \xi) d\xi dz$.

For
$$\int_{C'} \phi(\xi) d\xi = \int_{C'} \psi(\xi) d\xi + \int_{C'} \eta d\xi$$

$$= \int_{C_1} \int_{C'} f(z, \xi) d\xi dz + \int_{C'} \eta d\xi, \quad (\S 34, \text{example}).$$

Now $\left| \int_{C'} \eta d\xi \right| < \epsilon L$, where L is the length of C' . Hence $\int_{C_1} \int_{C'} f(z, \xi) d\xi dz$ tends to the limit $\int_{C'} \phi(\xi) d\xi$; so that

$$\int_{C'} \phi(\xi) d\xi = \int_C \int_{C'} f(z, \xi) d\xi dz.$$

The following two rules, the proofs of which are similar to those of § 59, are useful for determining the uniform convergency of integrals.

RULE I. Let the extremity z_1 be a finite point; then if, for all values of ξ in A' , a number $n < 1$ can be found such that $(z - z_1)^n f(z, \xi)$ tends uniformly to the limit $L(\xi)$ as z tends to z_1 , the integral $\int_C f(z, \xi) dz$ will be uniformly convergent.

RULE II. Let the extremity considered be at infinity; then if, for all values of ξ in A' , a number $n > 1$ can be found such that $z^n f(z, \xi)$ tends uniformly to the limit $L(\xi)$ as z tends to infinity along C , the integral $\int_C f(z, \xi) dz$ will be uniformly convergent.

Example 2. Consider the integral $\phi(z) = \int_0^\infty e^{-t} t^{z-1} dt$, where $R(z) > 0$.

Let $a \leq x = R(z) \leq b$, where $a > 0$; then, if $t > 1$,

$$|t^n e^{-t} t^{z-1}| = e^{-t} t^{z+n-1} \leq e^{-t} t^{b+n-1}.$$

But $\lim_{t \rightarrow \infty} e^{-t} t^{b+n-1} = 0$; hence the integral converges uniformly at its upper limit.

Again, if $t < 1$, $|t^n e^{-t} t^{z-1}| \leq e^{-t} t^{a+n-1}$.

Now choose a and n so that $a < 1$ and $(1-a) < n < 1$. Then

$$\lim_{t \rightarrow 0} e^{-t} t^{a+n-1} = 0;$$

hence the integral converges uniformly at its lower limit.

Now, if $R(z) > 0$, a and b can be chosen so that $a \leq R(z) \leq b$; hence $\phi(z)$ is holomorphic for $R(z) > 0$ and has the derivative $\int_0^\infty e^{-t} t^{z-1} \log t dt$.

It is easy to verify, by partial integration, that: (i) $\phi(z+1) = z\phi(z)$; (ii) $\phi(1) = 1$; (iii) if m is a positive integer, $\phi(m+1) = m!$.

Example 3. Consider the integral

$$\phi(\zeta) = \int_0^{\infty} \frac{\zeta}{\zeta^2 + z^2} \log z \, dz,$$

taken along a straight line which makes an angle ψ with the x -axis. If ζ satisfies the inequalities

$$\psi - \pi/2 + \epsilon \leq \text{amp } \zeta \leq \psi + \pi/2 - \epsilon, \quad r \leq |\zeta| \leq R,$$

where r is positive, all the values of ζ are excluded which make $\zeta^2 + z^2 = 0$.

Now, if $|z| = \rho > R$,

$$\left| \frac{\zeta^n}{\zeta^2 + z^2} \log z \right| < \frac{R\rho^n(|\log \rho| + |\psi|)}{\rho^2 - R^2};$$

which tends to zero as ρ tends to infinity if $1 < n < 2$; hence the integral converges uniformly at its upper limit.

Again, if $|z| = \rho < r$,

$$\left| \frac{\zeta^n}{\zeta^2 + z^2} \log z \right| < \frac{R\rho^n(|\log \rho| + |\psi|)}{r^2 - \rho^2};$$

which tends to zero as ρ tends to zero if $1 > n > 0$; hence the integral converges uniformly at its lower limit.

Accordingly, $\phi(\zeta)$ is holomorphic, provided $\psi - \pi/2 < \text{amp } \zeta < \psi + \pi/2$, $|\zeta| > 0$.

Example 4. Consider the integral

$$\phi(\zeta) = \int_0^{\infty} \frac{\zeta}{\zeta^2 + z^2} \log \left(\frac{1}{1 - e^{-2\pi z}} \right) dz,$$

taken along the path of *Example 2*, where $-\pi/2 < \psi < \pi/2$.

Let ζ be confined to the region defined by

$$\psi - \pi/2 + \epsilon \leq \text{amp } \zeta \leq \psi + \pi/2 - \epsilon, \quad r \leq |\zeta| \leq R.$$

Then, if $|z| = \rho > R$,

$$\left| \frac{\zeta^n}{\zeta^2 + z^2} \log \left(\frac{1}{1 - e^{-2\pi z}} \right) \right| < \frac{R\rho^n}{\rho^2 - R^2} \log \left(\frac{1}{1 - e^{-2\pi x}} \right), \quad (\S 39, \text{Example 1}),$$

where $x (= \rho \cos \psi)$ tends to infinity with ρ .

$$\text{Now, if } n < 2, \quad \lim_{\rho \rightarrow \infty} \frac{R\rho^n}{\rho^2 - R^2} \log \left(\frac{1}{1 - e^{-2\pi x}} \right) = 0;$$

hence the integral converges uniformly at its upper limit.

$$\text{Again,} \quad \log \left(\frac{1}{1 - e^{-2\pi z}} \right) = -\log z + \log f(z),$$

where $f(z)$ is holomorphic at $z=0$. Therefore, by *Example 2*, the integral converges uniformly at its lower limit.

Accordingly, $\phi(\zeta)$ is holomorphic, provided

$$\psi - \pi/2 < \text{amp } \zeta < \psi + \pi/2, \quad \zeta \neq 0.$$

61. The Gamma Function. Gauss's Definition. Let $\Gamma(z)$ denote the function

$$\text{Lim}_{n \rightarrow \infty} \frac{n! n^z}{z(z+1) \dots (z+n)}.$$

Then

$$\begin{aligned} \frac{1}{\Gamma(z)} &= \text{Lim}_{n \rightarrow \infty} \left\{ z \left(1 + \frac{z}{1}\right) \dots \left(1 + \frac{z}{n}\right) e^{-z \log n} \right\} \\ &= \text{Lim}_{n \rightarrow \infty} \left\{ z \left(1 + \frac{z}{1}\right) e^{-z} \left(1 + \frac{z}{2}\right) e^{-\frac{z}{2}} \dots \left(1 + \frac{z}{n}\right) e^{-\frac{z}{n}} e^{z \left(1 + \frac{1}{2} + \dots + \frac{1}{n} - \log n\right)} \right\} \\ &= e^{z^2} z \prod_1^{\infty} \left\{ \left(1 + \frac{z}{n}\right) e^{-\frac{z}{n}} \right\}; \end{aligned}$$

so that this definition is equivalent to that of § 50.

The following properties can easily be deduced from the latter definition:

- (i) $\Gamma(z+1) = z\Gamma(z)$;
- (ii) $\Gamma(m+1) = m!$, where m is a positive integer;
- (iii) $\Gamma(z)\Gamma(1-z) = \frac{\pi}{\sin \pi z}$;
- (iv) the residue at $z = -m$, where m is zero or a positive integer, is $(-1)^m/m!$.

The Function $\psi(z)$. Similarly, if $\psi(z) = \frac{d}{dz} \log \Gamma(z+1)$, we have:

- (i) $\psi(z+n) = \psi(z) + \sum_{r=1}^n \frac{1}{z+r}$;
- (ii) $\psi(0) = -\gamma$;
- (iii) $\psi(n) = 1 + \frac{1}{2} + \dots + \frac{1}{n} - \gamma$;
- (iv) $\psi(-z-1) = \psi(z) + \pi \cot \pi z$.

Gauss's Function $\Pi(z)$. The notation $\Pi(z)$ is frequently used instead of $\Gamma(z+1)$: thus

$$\Pi(z) = z\Pi(z-1), \quad \Pi(m) = m!, \quad \text{and} \quad \Pi(z-1)\Pi(-z) = \pi/\sin \pi z.$$

Euler's Definition. The Gamma Function may also be defined as the integral $\int_0^{\infty} e^{-tz} t^{-1} dt$, provided $R(z) > 0$. We shall now prove that the two definitions agree for values of z which satisfy this condition.

If $R(z) > 0$, and n is a positive integer, then, by partial integration,

$$\begin{aligned} \int_0^1 y^{z-1}(1-y)^n dy &= \frac{n}{z} \int_0^1 y^z(1-y)^{n-1} dy \\ &\dots\dots\dots \\ &= \frac{n(n-1)\dots 1}{z(z+1)\dots(z+n-1)} \int_0^1 y^{z+n-1} dy \\ &= \frac{n!}{z(z+1)\dots(z+n)}. \end{aligned}$$

Thus, writing $y = u/n$, we have

$$\frac{n!n^z}{z(z+1)\dots(z+n)} = \int_0^n \left(1 - \frac{u}{n}\right)^n u^{z-1} du;$$

so that

$$\Gamma(z) = \lim_{n \rightarrow \infty} \int_0^n \left(1 - \frac{u}{n}\right)^n u^{z-1} du.$$

Now let

$$f(u) = 1 - e^u \left(1 - \frac{u}{n}\right)^n,$$

where $0 \leq u \leq n$; then

$$f'(u) = e^u \left(1 - \frac{u}{n}\right)^{n-1} \frac{u}{n} \geq 0.$$

Thus $f(u)$ is an increasing function; so that

$$1 \geq e^u \left(1 - \frac{u}{n}\right)^n \geq 0, \quad \text{or} \quad e^{-u} \geq \left(1 - \frac{u}{n}\right)^n.$$

Again,

$$f(u) = \int_0^u f'(v) dv = \int_0^u e^v \left(1 - \frac{v}{n}\right)^{n-1} \frac{v}{n} dv \leq \frac{e^u}{n} \int_0^u v dv = e^u \frac{u^2}{2n}.$$

Accordingly, if $0 \leq u \leq n$,

$$0 \leq e^{-u} - \left(1 - \frac{u}{n}\right)^n \leq \frac{u^2}{2n}.$$

Now we can write

$$\begin{aligned} &\int_0^n \left\{ e^{-u} - \left(1 - \frac{u}{n}\right)^n \right\} u^{z-1} du \\ &= \int_0^a \left\{ e^{-u} - \left(1 - \frac{u}{n}\right)^n \right\} u^{z-1} du + \int_a^n e^{-u} u^{z-1} du - \int_a^n \left(1 - \frac{u}{n}\right)^n u^{z-1} du. \end{aligned}$$

Let a be chosen so large that, for all values of n greater than a ,

$$\left| \int_a^n e^{-u} u^{z-1} du \right| < \epsilon,$$

and therefore

$$\left| \int_a^n \left(1 - \frac{u}{n}\right)^n u^{z-1} du \right| < \epsilon;$$

then

$$\left| \int_0^n \left\{ e^{-u} - \left(1 - \frac{u}{n}\right)^n \right\} u^{z-1} du \right| < \left| \int_0^a \left\{ e^{-u} - \left(1 - \frac{u}{n}\right)^n \right\} u^{z-1} du \right| + 2\epsilon \\ < \left| \frac{a^{z+2}}{2n(z+2)} \right| + 2\epsilon.$$

Hence, if $R(z) > 0$,

$$\Gamma(z) = \lim_{n \rightarrow \infty} \int_0^n \left(1 - \frac{u}{n}\right)^n u^{z-1} du = \int_0^\infty e^{-u} u^{z-1} du.$$

The Gamma Function expressed as a Contour Integral. Euler's expression for $\Gamma(z)$ can be replaced by the following, which holds for all values of z .

Consider the integral $\int_C e^{-\xi} \xi^{z-1} d\xi$, where C is the contour of Fig. 60, with its initial and final points at infinity on the positive ξ -axis.

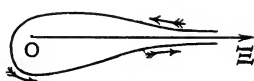

FIG. 60.

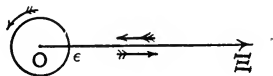

FIG. 61.

tive ξ -axis. The initial and final values of $\text{amp } \xi$ are taken to be 0 and 2π respectively.

Now replace C by the contour of Fig. 61, consisting of the ξ -axis from $+\infty$ to ϵ , the circle $|\xi| = \epsilon$, and the ξ -axis from ϵ to $+\infty$. Then, if $R(z) > 0$, we have, when ϵ tends to zero,

$$\int_C e^{-\xi} \xi^{z-1} d\xi = (e^{2\pi i} - 1) \int_0^\infty e^{-\xi} \xi^{z-1} d\xi \\ = (e^{2\pi i} - 1) \Gamma(z).$$

Now the functions on both sides of this equation are holomorphic for all values of z . Hence the equation holds for all values of z , and

$$\Gamma(z) = \frac{1}{e^{2\pi i} - 1} \int_C e^{-\xi} \xi^{z-1} d\xi.$$

Example 1. Prove that $\frac{1}{2\pi i} \int_C e^{\xi} \xi^{-z} d\xi = \frac{1}{\Gamma(z)}$,

where C denotes a path which starts from $-\infty$ on the ξ -axis, passes round the origin in the positive direction, and ends at $-\infty$ on the ξ -axis. The initial and final values of $\text{amp } \xi$ are taken to be $-\pi$ and π respectively.

Example 2. Gauss's Theorem. If $R(\gamma - \alpha - \beta) > 0$

$$F(\alpha, \beta, \gamma, 1) = \frac{\Gamma(\gamma)\Gamma(\gamma - \alpha - \beta)}{\Gamma(\gamma - \alpha)\Gamma(\gamma - \beta)}$$

For (§ 36, *Example 2*)

$$F(\alpha, \beta, \gamma, 1) = \frac{(\gamma - \alpha)(\gamma - \alpha + 1) \dots (\gamma - \alpha + n)(\gamma - \beta)(\gamma - \beta + 1) \dots (\gamma - \beta + n)}{\gamma(\gamma + 1) \dots (\gamma + n)(\gamma - \alpha - \beta)(\gamma - \alpha - \beta + 1) \dots (\gamma - \alpha - \beta + n)} \times F(\alpha, \beta, \gamma + n + 1, 1).$$

But
$$\frac{\Gamma(\gamma)\Gamma(\gamma - \alpha - \beta)}{\Gamma(\gamma - \alpha)\Gamma(\gamma - \beta)}$$

$$= \lim_{n \rightarrow \infty} \frac{(\gamma - \alpha)(\gamma - \alpha + 1) \dots (\gamma - \alpha + n)(\gamma - \beta)(\gamma - \beta + 1) \dots (\gamma - \beta + n)}{\gamma(\gamma + 1) \dots (\gamma + n)(\gamma - \alpha - \beta)(\gamma - \alpha - \beta + 1) \dots (\gamma - \alpha - \beta + n)};$$

and

$$\lim_{n \rightarrow \infty} F(\alpha, \beta, \gamma + n + 1, 1) = 1.$$

Hence
$$F(\alpha, \beta, \gamma, 1) = \frac{\Gamma(\gamma)\Gamma(\gamma - \alpha - \beta)}{\Gamma(\gamma - \alpha)\Gamma(\gamma - \beta)}$$

Example 3. If $R(\gamma) > 0$, $R(\gamma - \alpha - \beta) > 0$, shew that

$$F(-\alpha, -\beta, \gamma - \alpha - \beta, 1) = F(\alpha, \beta, \gamma, 1).$$

62. The Beta Function. Consider the integral of

$$f(z) = z^{p-1}(1-z)^{q-1}$$

taken round a closed contour which starts from a point A (Fig. 62) on the x -axis between 0 and 1, and is composed of:

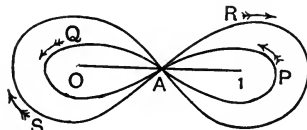

FIG. 62.

- (i) a circuit APA round $z=1$ in the positive direction;
- (ii) a circuit AQA round $z=0$ in the positive direction;
- (iii) a circuit ARA round $z=1$ in the negative direction;
- (iv) a circuit ASA round $z=0$ in the negative direction.

After describing this contour $f(z)$ returns to A with its initial amplitude, which we assume to be zero. The integrand is a multiform function; but since, at every point of the path, the branch integrated is uniform and continuous, the definition of § 26 holds for the integral. The notation

$$\int^{(1+, 0+, 1-, 0-)} f(z) dz$$

is used to denote this integral.

The path APA can be deformed into the contour consisting of: the x -axis from A to $1 - \epsilon$, the small circle $|z - 1| = \epsilon$ described positively, and the x -axis from $1 - \epsilon$ to A. Such a contour is called a (positive) *Loop*. If it had been described in the opposite direction, the loop would have been negative. Similarly the circuit AQA can be replaced by a positive loop about the origin, and the circuits ARA and ASA by negative loops about $z = 1$ and $z = 0$ respectively. As z describes the circular part of the first loop, the value of $f(z)$ changes from $f(x)$ to $f(x)e^{2q\pi i}$; similarly, the descriptions of the circular parts of the other three loops give $f(z)$ the values $f(x)e^{2(p+q)\pi i}$, $f(x)e^{2p\pi i}$, and $f(x)$ respectively.

We now make the radii of the circular parts of the loops tend to zero; then, if p and q are real and positive,

$$\begin{aligned} \int^{(1+, 0+, 1-, 0-)} z^{p-1}(1-z)^{q-1} dz &= \{1 - e^{2q\pi i} + e^{2(p+q)\pi i} - e^{2p\pi i}\} \int_0^1 x^{p-1}(1-x)^{q-1} dx \\ &= (1 - e^{2p\pi i})(1 - e^{2q\pi i}) B(p, q) \\ &= (1 - e^{2p\pi i})(1 - e^{2q\pi i}) \frac{\Gamma(p)\Gamma(q)}{\Gamma(p+q)}. \end{aligned}$$

Now the functions on both sides of this equation are holomorphic in p and q ; hence the relation holds for all values of p and q . Accordingly, if we define $B(p, q)$ by the equation

$$B(p, q) = \frac{\Gamma(p)\Gamma(q)}{\Gamma(p+q)},$$

we have, for all values of p and q ,

$$\int^{(1+, 0+, 1-, 0-)} z^{p-1}(1-z)^{q-1} dz = (1 - e^{2p\pi i})(1 - e^{2q\pi i}) B(p, q).$$

Example 1. With the same initial conditions, shew that

$$\int^{(1+, 0-, 1-, 0+)} z^{p-1}(1-z)^{q-1} dz = (1 - e^{-2p\pi i})(1 - e^{-2q\pi i}) B(p, q).$$

Example 2. By means of the transformation $x = (2\xi - 1)^2$, shew that, if $R(p) > 0$,

$$\int_0^1 x^{-1/2}(1-x)^{p-1} dx = 2^{2p-1} \int_0^1 \xi^{p-1}(1-\xi)^{p-1} d\xi.$$

Deduce that, for all values of p ,

$$(i) B(p, \frac{1}{2}) = 2^{2p-1} B(p, p), \quad (ii) \Gamma(2p) = \frac{2^{2p-1}}{\sqrt{\pi}} \Gamma(p) \Gamma(p + \frac{1}{2}).$$

The latter equation gives the *Duplication Formula* for the Gamma Function.

63. The Asymptotic Expansion of the Gamma Function.

From the expression

$$\frac{1}{\Gamma(z)} = ze^{\gamma z} \prod_1^{\infty} \left\{ \left(1 + \frac{z}{n}\right) e^{-\frac{z}{n}} \right\}$$

we derive the equation

$$\frac{d^2}{dz^2} \log \Gamma(z) = \sum_{n=0}^{\infty} \frac{1}{(z+n)^2}.$$

Now let C be a closed contour (Fig. 63) consisting of a semi-

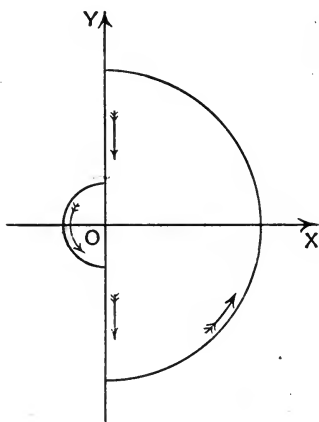

FIG. 63.

circle of radius $p+1/2$, where p is an integer, part of the y -axis, and a small semi-circle at O ; then, if $R(z) > 0$,

$$\sum_0^p \frac{1}{(z+n)^2} = \frac{1}{2\pi i} \int_C \frac{\pi \cot \pi \xi}{(z+\xi)^2} d\xi.$$

The integral of $(1/2i) \cot(\pi \xi) \cdot (z+\xi)^{-2}$ round the small semi-circle tends to $1/(2z^2)$, (§ 30, Th. 2). On the remaining part of C replace $(1/2i) \cot(\pi \xi)$ by

$$-\frac{1}{2} - \frac{1}{e^{-2\pi i \xi} - 1} \quad \text{or} \quad \frac{1}{2} + \frac{1}{e^{2\pi i \xi} - 1},$$

according as $I(\xi) \geq 0$. The integrals arising from the terms $-\frac{1}{2}$ and $+\frac{1}{2}$ each tend to

$$\frac{1}{2} \int_0^{p+\frac{1}{2}} \frac{d\xi}{(z+\xi)^2}.$$

Thus we find

$$\sum_0^p \frac{1}{(z+n)^2} = \frac{1}{2z^2} + \int_0^{p+1/2} \frac{d\xi}{(z+\xi)^2} + \int_0^{p+1/2} \left\{ \frac{i}{(z+i\eta)^2} - \frac{i}{(z-i\eta)^2} \right\} \frac{d\eta}{e^{2\pi\eta} - 1} + I,$$

where $\lim_{p \rightarrow \infty} I = 0$. Thus

$$\frac{d^2}{dz^2} \log \Gamma(z) = \frac{1}{2z^2} + \frac{1}{z} + \int_0^\infty \frac{4z\eta}{(z^2 + \eta^2)^2} \frac{d\eta}{e^{2\pi\eta} - 1}.$$

Hence $\frac{d}{dz} \log \Gamma(z) = K + \log z - \frac{1}{2z} - 2 \int_0^\infty \frac{\eta}{z^2 + \eta^2} \frac{d\eta}{e^{2\pi\eta} - 1},$

(§ 60, Ex. 1),

where the constant K must be real, since all the other terms are real when z is real. Therefore

$$\log \Gamma(z) = K' + Kz + (z - \frac{1}{2}) \log z - z + J(z),$$

where K' is a real constant, and

$$J(z) = -i \int_0^\infty \log \left(\frac{z+i\eta}{z-i\eta} \right) \frac{d\eta}{e^{2\pi\eta} - 1} = \frac{1}{\pi} \int_0^\infty \frac{z}{z^2 + \eta^2} \log \left(\frac{1}{1 - e^{-2\pi\eta}} \right) d\eta,$$

(§ 60, Ex. 4)

Now, since $\Gamma(x+1) = x\Gamma(x)$,

$$\begin{aligned} \log \Gamma(x+1) &= K' + K(x+1) + (x + \frac{1}{2}) \log(x+1) - (x+1) + J(x+1) \\ &= K' + Kx + (x + \frac{1}{2}) \log x - x + J(x); \end{aligned}$$

so that $K = -(x + \frac{1}{2}) \log \left(1 + \frac{1}{x} \right) + 1 + J(x) - J(x+1).$

But, if $x > 0$, $J(x) < \frac{1}{\pi x} \int_0^\infty \log \left(\frac{1}{1 - e^{-2\pi\eta}} \right) d\eta;^*$

hence $\lim_{x \rightarrow \infty} J(x) = 0$, and therefore $K = 0$.

Again, since $\Gamma(z)\Gamma(1-z) = \pi/\sin \pi z$,

$$\Gamma(\frac{1}{2} + iu)\Gamma(\frac{1}{2} - iu) = \frac{2\pi e^{-\pi u}}{1 + e^{-2\pi u}}.$$

Therefore

$$\begin{aligned} R \log \Gamma(\frac{1}{2} + iu) &= \log \sqrt{2\pi} - \frac{\pi u}{2} + \frac{1}{2} \log \left(\frac{1}{1 - e^{-2\pi u}} \right) \\ &= K' - u \tan^{-1}(2u) - \frac{1}{2} + R J(\frac{1}{2} + iu), \end{aligned}$$

where $\tan^{-1}(2u)$ denotes the acute angle whose tangent is $2u$.

* $-\int_0^\infty \log(1 - e^{-2\pi\eta}) d\eta = -\frac{1}{2\pi} \int_0^1 \log(1-x) \frac{dx}{x}$, where $x = e^{-2\pi\eta}$
 $= -\frac{1}{2\pi} \int_0^1 \frac{\log x}{1-x} dx = \frac{\pi}{12}.$

Now, if x and y are positive,

$$\begin{aligned} \text{RJ}(x+iy) &= \frac{1}{\pi} \int_0^\infty \frac{x(x^2+y^2+\eta^2)}{(x^2+y^2+\eta^2+2y\eta)\{x^2+(y-\eta)^2\}} \log\left(\frac{1}{1-e^{-2\pi\eta}}\right) d\eta \\ &< \frac{x}{\pi(x^2+y^2/4)} \int_0^{y/2} \log\left(\frac{1}{1-e^{-2\pi\eta}}\right) d\eta + \log\left(\frac{1}{1-e^{-\pi y}}\right) \int_{y/2}^\infty \frac{x d\eta}{x^2+(y-\eta)^2} \\ &< \frac{4x}{\pi y^2} \int_0^\infty \log\left(\frac{1}{1-e^{-2\pi\eta}}\right) d\eta + \log\left(\frac{1}{1-e^{-\pi y}}\right) \int_{-\infty}^\infty \frac{x d\eta}{x^2+\eta^2}. \end{aligned}$$

Thus $\lim_{u \rightarrow \infty} \text{RJ}(\frac{1}{2} + iu) = 0$; so that (§ 40, Ex. 2), $K' = \log \sqrt{2\pi}$.

Therefore $\log \Gamma(z) = \log \sqrt{2\pi} + (z - \frac{1}{2}) \log z - z + J(z)$.

Again, let $J_\psi(z)$ denote the integral (§ 60, Example 4),

$$\frac{1}{\pi} \int_0^\infty \frac{z}{z^2 + \xi^2} \log\left(\frac{1}{1-e^{-2\pi\xi}}\right) d\xi,$$

taken along a straight line making an angle ψ with the ξ -axis, where $-\pi/2 < \psi < \pi/2$ and $z \neq 0$. Then, since, for values of $\text{amp } \xi$ between 0 and ψ ,

$$\frac{\xi x}{x^2 + \xi^2} \log\left(\frac{1}{1-e^{-2\pi\xi}}\right)$$

tends uniformly to zero as ξ tends to infinity, $J_\psi(x) = J(x)$, (§ 30, Th. 1).

Now $J_\psi(z)$ is holomorphic for the region R_ψ defined by

$$\psi - \pi/2 < \text{amp } z < \psi + \pi/2, \quad z \neq 0.$$

Also, corresponding to any point z for which $-\pi < \text{amp } z < \pi$

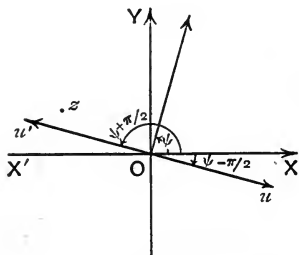

FIG. 64.

and $z \neq 0$, a value of ψ can be found (Fig. 64) such that the positive x -axis and the point z both lie in R_ψ . Accordingly, by

the principle of analytical continuation, since $\Gamma(z)$ and $\log z$ are holomorphic provided $-\pi < \text{amp } z < \pi$ and $z \neq 0$,

$$\begin{aligned} \log \Gamma(z) &= \log \sqrt{2\pi} + (z - \frac{1}{2}) \log z - z + J_\psi(z) \\ &= \log \sqrt{2\pi} + (z - \frac{1}{2}) \log z - z \\ &\quad + \frac{1}{\pi} \int_0^\infty \left\{ \frac{1}{z} - \frac{\xi^2}{z^3} + \frac{\xi^4}{z^5} - \dots + (-1)^{n-1} \frac{\xi^{2n-2}}{z^{2n-1}} \right\} \log \left(\frac{1}{1 - e^{-2\pi\xi}} \right) d\xi \\ &\quad + J_n(z), \end{aligned}$$

where
$$J_n(z) = \frac{(-1)^n}{z^{2n-1}} \frac{1}{\pi} \int_0^\infty \frac{\xi^{2n}}{z^2 + \xi^2} \log \left(\frac{1}{1 - e^{-2\pi\xi}} \right) d\xi.$$

But, (§ 30, Th. 1),

$$\begin{aligned} \frac{1}{\pi} \int_0^\infty \xi^{2k-2} \log \left(\frac{1}{1 - e^{-2\pi\xi}} \right) d\xi \\ = \frac{1}{\pi} \int_0^\infty \xi^{2k-2} \log \left(\frac{1}{1 - e^{-2\pi\xi}} \right) d\xi = \frac{B_k}{2k(2k-1)}. \end{aligned}$$

Hence $\log \Gamma(z) = \log \sqrt{2\pi} + (z - \frac{1}{2}) \log z - z$

$$\begin{aligned} + \frac{B_1}{1 \cdot 2} \frac{1}{z} - \frac{B_2}{3 \cdot 4} \frac{1}{z^3} + \dots + (-1)^{n-1} \frac{B_n}{(2n-1)2n} \frac{1}{z^{2n-1}} \\ + J_n(z). \end{aligned}$$

Also the least value of $|z \pm i\xi|$ is the perpendicular distance of z from the line uOu' (Fig. 64). Thus, $|z \pm i\xi| \geq \lambda |z|$, where $\lambda = \cos(\phi - \psi)$, ($\text{amp } z = \phi$); so that $0 < \lambda \leq 1$; hence

$$\left| \frac{1}{z^2 + \xi^2} \right| \leq \frac{1}{\lambda^2 |z|^2}.$$

Therefore

$$\begin{aligned} |J_n(z)| &< \frac{1}{\lambda^2 |z|^{2n+1}} \frac{1}{\pi} \int_0^\infty |\xi|^{2n} \log \left(\frac{1}{1 - e^{-2\pi\xi}} \right) |d\xi|, \quad (\S 39, \text{Ex. 1}) \\ &< \frac{1}{\lambda^2 |z|^{2n+1} (\cos \psi)^{2n+1}} \frac{1}{\pi} \int_0^\infty \xi^{2n} \log \left(\frac{1}{1 - e^{-2\pi\xi}} \right) d\xi \\ &< \frac{1}{\lambda^2 |z|^{2n+1} (\cos \psi)^{2n+1} (2n+1)(2n+2)}, \quad (n=0, 1, 2, \dots). \end{aligned}$$

The infinite series

$$\frac{B_1}{1 \cdot 2} \frac{1}{z} - \frac{B_2}{3 \cdot 4} \frac{1}{z^3} + \frac{B_3}{5 \cdot 6} \frac{1}{z^5} - \dots$$

is divergent (cf. § 58); but $J_n(z)$ can be made arbitrarily small by increasing z , so that, for sufficiently large values of $|z|$,

a finite number of terms gives the value of the function to any approximation required, provided $-\pi < \text{amp } z < \pi$. The series is therefore asymptotic.

COROLLARY 1. For all values of $\text{amp } z$ such that

$$-\pi + \delta \leq \text{amp } z \leq \pi + \delta,$$

$\Gamma(z)/(\sqrt{2\pi} z^{z-1/2} e^{-z})$ tends uniformly to the limit unity as z tends to infinity.

COROLLARY 2. If z is real and positive, we can take $\psi = 0$. Then $\lambda = 1$, and

$$|J_n(z)| < \frac{B_{n+1}}{(2n+1)(2n+2)} \frac{1}{z^{2n+1}};$$

so that the remainder after any term in the series for $\log \Gamma(z)$ is numerically less than the succeeding term.

COROLLARY 3. $m! = \sqrt{2\pi m} \left(\frac{m}{e}\right)^m e^{\frac{\theta}{12m}}$, where $0 < \theta < 1$: this is known as *Stirling's Formula*. The expression $\sqrt{2\pi m} \left(\frac{m}{e}\right)^m$ is usually spoken of as the approximation to $m!$ when m is large.

Example 1. Prove $\int_0^\infty \tan^{-1} t \frac{dt}{e^{2\pi t} - 1} = \frac{1}{2}(1 - \log \sqrt{2\pi})$,

where the principal value of $\tan^{-1} t$ is taken.

Let C denote the rectangle of Fig. 59; then

$$\log(1 \cdot 2 \cdot 3 \dots n) = \frac{1}{2\pi i} \int_C \pi \cot \pi z \log z \, dz.$$

Hence, by the process employed in § 58, we obtain

$$\log(1 \cdot 2 \cdot 3 \dots n) = \frac{1}{2} \log n + \int_1^n \log x \, dx - 2 \int_0^\infty \frac{\tan^{-1} y \, dy}{e^{2\pi y} - 1} + 2 \int_0^\infty \frac{\tan^{-1}(y/n) \, dy}{e^{2\pi y} - 1}.$$

Again, $\log(1 \cdot 2 \cdot 3 \dots n) = \log \sqrt{2\pi} + (n + \frac{1}{2}) \log n - n + \frac{\theta}{12n}$, $0 < \theta < 1$.

But
$$\int_0^\infty \frac{\tan^{-1}(y/n) \, dy}{e^{2\pi y} - 1} < \frac{1}{n} \int_0^\infty \frac{y}{e^{2\pi y} - 1} \, dy;$$

so that

$$\lim_{n \rightarrow \infty} \int_0^\infty \frac{\tan^{-1}(y/n) \, dy}{e^{2\pi y} - 1} = 0.$$

Hence, if n tends to infinity, we have

$$\int_0^\infty \frac{\tan^{-1} y \, dy}{e^{2\pi y} - 1} = \frac{1}{2}(1 - \log \sqrt{2\pi}).$$

Example 2. Shew that, if $-\pi < \text{amp } z < \pi$,

$$\lim_{z \rightarrow \infty} \frac{\Gamma(\alpha+z)\Gamma(\beta+z)}{\Gamma(\gamma+z)\Gamma(1+z)} z^{-\alpha-\beta+\gamma+1} = 1.$$

Example 3. Shew that, if $-\pi/2 < \text{amp } \zeta < \pi/2$ and $\zeta \neq 0$,

$$\frac{1}{2\pi i} \int_{-a-\infty i}^{-a+\infty i} \Gamma(-z) \zeta^z dz = -\frac{1}{2\pi i} \int_{-a-\infty i}^{-a+\infty i} \frac{\zeta^z}{\Gamma(z+1)} \frac{\pi dz}{\sin \pi z} = e^{-\zeta},$$

where $a > 0$ and the path of integration is a straight line.

If $z = Re^{i\theta}$, where $-\pi < \theta < \pi$,

$$\begin{aligned} \text{Lim}_{z \rightarrow \infty} \left| \frac{1}{\Gamma(z+1)} \right| &= \text{Lim}_{z \rightarrow \infty} \left| \frac{1}{z \Gamma(z)} \right| = \text{Lim}_{z \rightarrow \infty} \left| \frac{1}{\sqrt{2\pi} z^{1/2}} e^{z-z \log z} \right| \\ &= \text{Lim}_{R \rightarrow \infty} \frac{1}{\sqrt{2\pi} R^{1/2}} e^{R \cos \theta (1 - \log R) + R \sin \theta}. \end{aligned}$$

Hence, if $\zeta = \rho e^{i\phi}$ and $\theta \neq 0$,

$$\text{Lim}_{z \rightarrow \infty} \left| \frac{\zeta^z \pi}{\Gamma(z+1) \sin \pi z} \right| = \sqrt{2\pi} \text{Lim}_{R \rightarrow \infty} \frac{1}{R^{1/2}} e^{R \cos \theta (1 + \log \rho - \log R) + R \sin \theta (\theta - \phi \mp \pi)},$$

according as $\sin \theta$ is positive or negative.

Accordingly, if $\pi/2 \geq \theta \geq \epsilon$, or if $-\pi/2 \leq \theta \leq -\epsilon$, or if $-\alpha \leq R \cos \theta \leq 0$,

$$z^n \frac{\zeta^z \pi}{\Gamma(z+1) \sin \pi z}$$

tends uniformly to zero as z tends to infinity. Thus (§ 60, Rule II.) the given integral is uniformly convergent.

Next, if $-\epsilon \leq \theta \leq \epsilon$, let $z = R_m e^{i\theta}$, where $R_m = m + 1/2$ and m is an integer; then

$$\text{Lim}_{m \rightarrow \infty} \left| \frac{\zeta^z \pi}{\Gamma(z+1) \sin \pi z} \right| \leq \sqrt{2\pi} M \text{Lim}_{m \rightarrow \infty} \frac{1}{R_m^{1/2}} e^{R_m \{-\cos \epsilon (\log R_m - 1 - \log \rho) + \sin \epsilon |\theta - \phi|\}},$$

where $2M \geq |\text{cosec } \pi z|$ (§ 51, *Lemma*). Hence

$$z \frac{\zeta^z \pi}{\Gamma(z+1) \sin \pi z}$$

tends uniformly to zero as m tends to infinity.

It follows (§ 30, Th. I.) that the given contour can be replaced by a closed contour consisting of the line $x = -a$ and that part of the circle $|z| = m + 1/2$, where m may be increased indefinitely, which lies to the right of this line.

Now the only poles within this contour are those of $1/\sin \pi z$; hence

$$-\frac{1}{2\pi i} \int_{-a-\infty i}^{-a+\infty i} \frac{\zeta^z}{\Gamma(z+1)} \frac{\pi dz}{\sin \pi z} = 1 - \frac{\zeta}{1!} + \frac{\zeta^2}{2!} - \dots = e^{-\zeta}.$$

*Example 4.** Shew that the integral

$$\frac{1}{2\pi i} \int \frac{\Gamma(\alpha+z)\Gamma(\beta+z)}{\Gamma(\gamma+z)} \Gamma(-z)(-\zeta)^z dz,$$

where $-\pi < \text{amp}(-\zeta) < \pi$, and the integral is taken upwards along a straight line (Fig. 65) parallel to the y -axis, with loops, if necessary, to ensure that the poles $0, 1, 2, 3, \dots$, are to the right of the contour, while the poles $-\alpha, -\alpha-1, -\alpha-2, \dots, -\beta, -\beta-1, -\beta-2, \dots$, are to the left of the contour, is uniformly convergent. Negative integral and zero values

* Cf. E. W. Barnes, *Proc. Lond. Math. Soc.*, Ser. 2, Vol. 6, Parts 2 and 3,

of α and β are excluded, since the curve could not, under such conditions, be drawn. Also shew that, if $|\zeta| < 1$, the integral has the value

$$\frac{\Gamma(\alpha)\Gamma(\beta)}{\Gamma(\gamma)} F(\alpha, \beta, \gamma, \zeta);$$

while, if $|\zeta| > 1$, it is equal to

$$\begin{aligned} & (-\zeta)^{-\alpha} \frac{\Gamma(\beta-\alpha)\Gamma(\alpha)}{\Gamma(\gamma-\alpha)} F\left(\alpha, 1-\gamma+\alpha, 1-\beta+\alpha, \frac{1}{\zeta}\right) \\ & + (-\zeta)^{-\beta} \frac{\Gamma(\alpha-\beta)\Gamma(\beta)}{\Gamma(\gamma-\beta)} F\left(\beta, 1-\gamma+\beta, 1-\alpha+\beta, \frac{1}{\zeta}\right). \end{aligned}$$

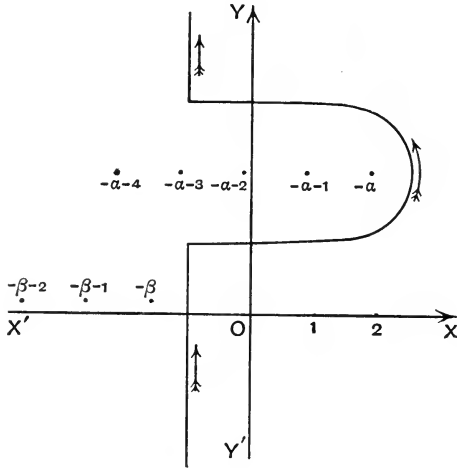

FIG. 65.

Firstly, let $-\zeta = \rho e^{i\phi}$, where $\rho < 1$; also, let $z = R e^{i\theta}$. Then, if $\epsilon \leq \theta \leq \pi/2$, or if $-\pi/2 \leq \theta \leq -\epsilon$, where $\tan \epsilon < \frac{1}{\pi} \log(1/\rho)$,

$$\lim_{z \rightarrow \infty} \left| \frac{(-\zeta)^z}{\sin \pi z} \right| = \lim_{R \rightarrow \infty} 2e^{-R \cos \theta \log(1/\rho) - R \sin \theta (\phi \pm \pi)},$$

according as $\sin \theta$ is positive or negative. Accordingly, since $-\pi < \phi < \pi$,

$$z^n \frac{\Gamma(\alpha+z)\Gamma(\beta+z)}{\Gamma(\gamma+z)} \Gamma(-z)(-\zeta)^z \quad \text{or} \quad -z^n \frac{\Gamma(\alpha+z)\Gamma(\beta+z)}{\Gamma(\gamma+z)\Gamma(1+z)} \frac{(-\zeta)^z \pi}{\sin \pi z}$$

tends uniformly to zero as z tends to infinity. Thus the given integral is uniformly convergent.

Again, if $-\epsilon \leq \theta \leq \epsilon$,

$$\lim_{z \rightarrow \infty} |(-\zeta)^z| < \lim_{R \rightarrow \infty} e^{-R\pi \cos \epsilon \left\{ \frac{1}{\pi} \log(1/\rho) - \tan \epsilon \right\}};$$

so that, if $R = m + 1/2$, where m is integral,

$$z \frac{\Gamma(\alpha+z)\Gamma(\beta+z)}{\Gamma(\gamma+z)} \Gamma(-z)(-\zeta)^z$$

tends uniformly to zero as m tends to infinity. Hence it follows, as in *Example 3*, that the integral has the value

$$\frac{\Gamma(\alpha)\Gamma(\beta)}{\Gamma(\gamma)}F(\alpha, \beta, \gamma, \zeta).$$

Secondly, let $\rho > 1$. Then, since

$$\frac{\Gamma(\alpha+z)\Gamma(\beta+z)}{\Gamma(\gamma+z)}\Gamma(-z) = \frac{\Gamma(1-\gamma-z)\Gamma(-z)}{\Gamma(1-\alpha-z)\Gamma(1-\beta-z)} \frac{\pi \sin \pi(\gamma+z)}{\sin \pi(\alpha+z) \sin \pi(\beta+z)},$$

it can be shewn as before that the integral is uniformly convergent, and that the path can be replaced by a closed contour consisting of the given line and an infinite semi-circle to the left of the γ -axis. The required expression for the integral is then obtained by taking the sum of the residues within this contour.

An exceptional case occurs when α and β are zero or differ by a positive integer. Let $\alpha = \beta + m$, where m is zero or a positive integer; then the integrand has poles of the second order at the points $-\alpha, -\alpha-1, -\alpha-2, \dots$. Now the integrand can be written

$$\frac{(-1)^{m\pi^2} \Gamma(-z)(-\zeta)^z}{\{\sin \pi(\alpha+z)\}^2 \Gamma(1-\alpha-z)\Gamma(1-\beta-z)\Gamma(\gamma+z)};$$

so that the residue at the point $-\alpha-n$ is

$$(-1)^m \left[\frac{d}{dz} \frac{\Gamma(-z)(-\zeta)^z}{\Gamma(1-\alpha-z)\Gamma(1-\alpha+m-z)\Gamma(\gamma+z)} \right]_{z=-\alpha-n}.$$

Hence the integral is equal to

$$\begin{aligned} & (-\zeta)^{-\beta} \frac{\Gamma(m)\Gamma(\beta)}{\Gamma(\gamma-\beta)} \sum_{n=0}^{m-1} (-1)^n \frac{\beta(\beta+1)\dots(\beta+n-1)}{n!(m-n)(m-n+1)\dots(m-1)} \frac{1}{\zeta^n} \\ & + (-\zeta)^{-\alpha} \frac{(-1)^m \Gamma(\alpha)}{\Gamma(\gamma-\alpha)} \sum_{n=0}^{\infty} \frac{\alpha(\alpha+1)\dots(\alpha+n-1)(\alpha-\gamma+1)(\alpha-\gamma+2)\dots(\alpha-\gamma+n)}{n!(m+n)!} \\ & \quad \times \{ \log(-\zeta) - \psi(\alpha+n-1) + \psi(n) + \psi(m+n) - \psi(\gamma-\alpha-n-1) \} \frac{1}{\zeta^n}. \end{aligned}$$

Let $\text{amp } \zeta = \psi$; then, since $-\pi < \text{amp } (-\zeta) < \pi$, it follows that, if $0 < \psi \leq \pi$, $\text{amp } (-\zeta) = \psi - \pi$; while, if $0 > \psi \geq -\pi$, $\text{amp } (-\zeta) = \psi + \pi$.

Accordingly, the analytical continuation of $F(\alpha, \beta, \gamma, \zeta)$ when $|\zeta| > 1$ is

$$\begin{aligned} & e^{\pm \alpha \pi i} \zeta^{-\alpha} \frac{\Gamma(\gamma)\Gamma(\beta-\alpha)}{\Gamma(\beta)\Gamma(\gamma-\alpha)} F\left(\alpha, 1-\gamma+\alpha, 1-\beta+\alpha, \frac{1}{\zeta}\right) \\ & + e^{\pm \beta \pi i} \zeta^{-\beta} \frac{\Gamma(\gamma)\Gamma(\alpha-\beta)}{\Gamma(\alpha)\Gamma(\gamma-\beta)} F\left(\beta, 1-\gamma+\beta, 1-\alpha+\beta, \frac{1}{\zeta}\right), \end{aligned}$$

according as $0 < \text{amp } \zeta \leq \pi$ or $-\pi \leq \text{amp } \zeta < 0$. If α and β differ by an integer, the corresponding changes must be made in the expression.

If a cross-cut is taken along the real axis from 1 to $+\infty$, the function is then uniform in the whole ζ -plane.

Example 5. Prove

$$\int_x^{x+1} \log \{ \Gamma(z) \} dz = \log \sqrt{2\pi} + x \log x - x.$$

If x is real and positive,

$$\log \Gamma(x) = \log \sqrt{2\pi} + (x - \frac{1}{2}) \log x - x + \frac{\theta}{12x},$$

where $0 < \theta < 1$.

Hence $\int_x^{x+1} \log \{\Gamma(x)\} dx$

$$= \log \sqrt{2\pi} + x \log x + \frac{x(x+1)}{2} \log \left(1 + \frac{1}{x}\right) - \frac{3}{2}x - \frac{1}{4} + \frac{\theta'}{12} \log \left(1 + \frac{1}{x}\right),$$

where $0 < \theta' < 1$,

$$= \log \sqrt{2\pi} + x \log x - x + \epsilon(x),$$

where $\epsilon(x)$ tends to zero as x tends to infinity.

Again, $\frac{d}{dx} \int_x^{x+1} \log \{\Gamma(x)\} dx = \log x$;

so that $\int_x^{x+1} \log \{\Gamma(x)\} dx = K + x \log x - x$,

where K is a constant.

Thus K must be $\log \sqrt{2\pi}$, and therefore

$$\int_x^{x+1} \log \{\Gamma(x)\} dx = \log \sqrt{2\pi} + x \log x - x.$$

Now the functions on both sides of this equation are holomorphic for all values of the variable, provided that a cross-cut is taken along the negative real axis from 0 to $-\infty$. Hence (§ 55)

$$\int_z^{z+1} \log \{\Gamma(z)\} dz = \log \sqrt{2\pi} + z \log z - z.$$

EXAMPLES VIII.

1. Show that

$$\lim_{n \rightarrow \infty} \frac{z(z+1)\dots(z+2n-1)}{1 \cdot 3 \cdot 5 \dots (2n-1)2z(2z+2)\dots(2z+2n-2)} = 2^{z-1}.$$

2. If $\sum a = \sum b$ (Examples VI. 31), show that

$$\frac{\Gamma(1+b_1)\Gamma(1+b_2)\dots\Gamma(1+b_k)}{\Gamma(1+a_1)\Gamma(1+a_2)\dots\Gamma(1+a_k)} = \prod_1^{\infty} w_n,$$

where

$$w_n = \frac{(n+a_1)(n+a_2)\dots(n+a_k)}{(n+b_1)(n+b_2)\dots(n+b_k)}.$$

3. Prove that $\prod_1^{\infty} \left\{ \frac{n(n+a+b)}{(n+a)(n+b)} \right\} = \frac{\Gamma(1+a)\Gamma(1+b)}{\Gamma(1+a+b)}$.

4. Prove that

$$(1-z)(1+\frac{1}{2}z)(1-\frac{1}{3}z)(1+\frac{1}{4}z)\dots = \frac{\Gamma(\frac{1}{2})}{\Gamma(1+\frac{1}{2}z)\Gamma(\frac{1}{2}-\frac{1}{2}z)}.$$

5. If m is an integer, show that

$$\frac{m^{mz} \Gamma(z) \Gamma\left(z + \frac{1}{m}\right) \dots \Gamma\left(z + \frac{m-1}{m}\right)}{\Gamma(mz)} = (2\pi)^{\frac{m-1}{2}} m^{\frac{1}{2}}.$$

6. If a and b are real and > 0 , and $R(n) > 0$, show that

$$(i) \frac{1}{2\pi} \int_{-\infty}^{\infty} e^{a(b+xi)} \frac{dx}{(b+xi)^{n+1}} = \frac{a^n}{\Gamma(n)};$$

$$(ii) \int_{-\infty}^{\infty} e^{-a(b+xi)} \frac{dx}{(b+xi)^{n+1}} = 0.$$

[In (i) integrate $e^{az}z^{-n-1}$ along $x=b$, and shew that this path can be deformed into that of *Example 1*, § 61; in (ii) integrate $e^{-az}z^{-n-1}$ round the contour consisting of $x=b$ and an infinite semi-circle.]

7. If p is a positive integer and $R(n) > -1$, shew that

$$\int_{-1}^{(-1+, +1-)} z^p (z^2 - 1)^n dz = 2i \sin(n\pi) \int_{-1}^1 z^p (1 - z^2)^n dz,$$

where O is the initial point, and the initial value of $\text{amp}(z^2 - 1)$ is $-\pi$. Deduce that, for all values of n , the integral vanishes when p is odd, and that its value when p is even is

$$2i \sin(n\pi) B\left(n+1, \frac{p+1}{2}\right).$$

8. Shew that, for all values of z ,

$$B(z, z)B(z+1/2, z+1/2) = \pi 2^{1-4z}/z.$$

9. Prove $\frac{\Gamma(1/2+z)}{\Gamma(1/2-z)} \{\Gamma(-z)\}^2 = \frac{\{\Gamma(1+2z)\}^2}{\{\Gamma(1+z)\}^4} \left(\frac{\pi}{\sin \pi z}\right)^2 \frac{\cos \pi z}{2^{2z}}$.

10. If n is a positive integer, shew that

$$B(np, nq) = n^{-nq} \frac{B(p, q)B(p+1/n, q) \dots B\{p+(n-1)/n, q\}}{B(q, q)B(2q, q) \dots B\{(n-1)q, q\}}$$

11. If $R(z) > 0$ and $\text{amp } z = \psi$, shew that

$$\int_0^\infty \frac{e^{-zt} dt}{1+t^2} = \frac{1}{z} - \frac{2!}{z^3} + \frac{4!}{z^5} - \dots + (-1)^{n-1} \frac{(2n-2)!}{z^{2n-1}} + (-1)^n R_n,$$

where

$$|R_n| < \frac{(2n)!}{|z|^{2n+1}} \frac{1}{\cos^2 \psi}.$$

Deduce that the expansion is asymptotic if $-\pi/2 < \psi < \pi/2$.

[Replace the path of integration by a straight line from O to infinity which makes an angle $-\psi$ with the positive real axis, and shew that, for points on this line, $|t^2+1| \cong \cos^2 \psi$.]

12. If $-\pi/2 < \text{amp } z = \psi < \pi/2$, prove the asymptotic expansion

$$\int_0^\infty \frac{e^{-zt}}{1+t^2} dt = \frac{\sqrt{\pi}}{2\sqrt{z}} \left\{ 1 - \frac{1}{2z} + \frac{1 \cdot 3}{(2z)^2} - \dots + (-1)^{n-1} \frac{1 \cdot 3 \cdot 5 \dots (2n-3)}{(2z)^{n-1}} \right\} + (-1)^n R_n,$$

where

$$|R_n| < \left| \frac{\sqrt{\pi}}{2\sqrt{z}} \frac{1 \cdot 3 \cdot 5 \dots (2n-1)}{(2z)^n} \right|.$$

13. If $s < 1$ and $-\pi/2 < \text{amp } z = \psi < \pi/2$, prove the asymptotic expansion

$$\int_0^\infty \frac{e^{-zt} t^{-s}}{1+t} dt = z^s \left\{ \frac{\Gamma(1-s)}{z} - \frac{\Gamma(2-s)}{z^2} + \dots + (-1)^{n-1} \frac{\Gamma(n-s)}{z^n} \right\} + (-1)^n R_n,$$

where

$$|R_n| < \left| z^s \frac{\Gamma(n+1-s)}{z^{n+1}} \right|.$$

14. If $R(\gamma - \alpha - \beta) > 0$, prove

$$\begin{aligned} \sin \pi \alpha \frac{\Gamma(\alpha)\Gamma(\beta-\alpha)}{\Gamma(\gamma-\alpha)} F(\alpha, 1-\gamma+\alpha, 1-\beta+\alpha, 1) \\ + \sin \pi \beta \frac{\Gamma(\beta)\Gamma(\alpha-\beta)}{\Gamma(\gamma-\beta)} F(\beta, 1-\gamma+\beta, 1-\alpha+\beta, 1) = 0. \end{aligned}$$

15. If $R(\gamma - \alpha - \beta) > 0$, prove

$$\frac{\Gamma(\alpha)\Gamma(\beta)}{\Gamma(\gamma)} F(\alpha, \beta, \gamma, 1) = \cos \pi\alpha \frac{\Gamma(\alpha)\Gamma(\beta - \alpha)}{\Gamma(\gamma - \alpha)} F(\alpha, 1 - \gamma + \alpha, 1 - \beta + \alpha, 1) \\ + \cos \pi\beta \frac{\Gamma(\beta)\Gamma(\alpha - \beta)}{\Gamma(\gamma - \beta)} F(\beta, 1 - \gamma + \beta, 1 - \alpha + \beta, 1).$$

16. If $R(q) > 1$, prove

$$B(p, q) + B(p+1, q) + B(p+2, q) + \dots = B(p, q-1).$$

17. If $R(p-a) > 0$, prove

$$\frac{B(p-a, q)}{B(p, q)} = 1 + \frac{aq}{p+q} + \frac{a(a+1)q(q+1)}{1 \cdot 2(p+q)(p+q+1)} + \dots$$

18. If $R(p+s) > 0$, prove

$$B(p, p+s) = \frac{B(p, p)}{2^s} \left\{ 1 + \frac{s(s-1)}{2(2p+1)} + \frac{s(s-1)(s-2)(s-3)}{2 \cdot 4 \cdot (2p+1)(2p+3)} + \dots \right\}.$$

19. If $z = \alpha + iy$, where α is a positive constant, shew that the limiting value of $|\Gamma(1+z)|$ when y tends to $+\infty$ is

$$\sqrt{2\pi} |z|^{\alpha+1/2} e^{-\pi y/2}.$$

20. Shew that the analytical continuation of $F(\alpha, \beta, \gamma, 1/z)$ for $|z| < 1$ is

$$e^{\mp a\pi i z \alpha} \frac{\Gamma(\gamma)\Gamma(\beta - \alpha)}{\Gamma(\beta)\Gamma(\gamma - \alpha)} F(\alpha, 1 - \gamma + \alpha, 1 - \beta + \alpha, z) \\ + e^{\mp \beta\pi i z \beta} \frac{\Gamma(\gamma)\Gamma(\alpha - \beta)}{\Gamma(\alpha)\Gamma(\gamma - \beta)} F(\beta, 1 - \gamma + \beta, 1 - \alpha + \beta, z),$$

according as $0 < \text{amp } z \leq \pi$ or $-\pi \leq \text{amp } z < 0$.

21. Shew that

$$\frac{1}{2\pi i} \int \Gamma(\alpha+z)\Gamma(\beta+z)\Gamma(\gamma-z)\Gamma(\delta-z) dz \\ = \frac{\Gamma(\alpha+\gamma)\Gamma(\alpha+\delta)\Gamma(\beta+\gamma)\Gamma(\beta+\delta)}{\Gamma(\alpha+\beta+\gamma+\delta)}$$

where the integral is taken along a contour similar to that of *Example 4*, § 63. Values of $\alpha, \beta, \gamma, \delta$, which would make it impossible to draw the contour, are excluded.

22. If $R(p) > 0$, shew that

$$\sum_{r=0}^{n-1} \frac{\Gamma(r-p)}{\Gamma(r+1)} = -\frac{\Gamma(n-p)}{p\Gamma(n)}.$$

23. Prove

$$\Gamma(z) = \lim_{n \rightarrow \infty} n^z B(z, n).$$

24. If $R(z) > 0$, shew that

$$(i) \Gamma(z) = \int_0^1 \left(\log \frac{1}{t}\right)^{z-1} dt; \quad (ii) \Gamma(z) = \int_{-\infty}^{\infty} e^{-t} e^{tz} dt.$$

25. Shew that, if $R(z) > -1$,

$$\psi(z) = \frac{1}{\Gamma(z+1)} \int_0^{\infty} e^{-t} t^z \log t dt;$$

and deduce that

$$\gamma = \int_0^1 \log \left(\frac{1}{\log \frac{1}{x}} \right) dx.$$

26. Shew that, if $R(z) > 0$, $R(\zeta) > 0$,

$$\Gamma(z) = \zeta^z \int_0^\infty e^{-t\zeta} t^{z-1} dt.$$

Deduce
$$\int_0^\infty e^{-t\zeta} t^{z-1} \log t dt = \frac{\Gamma(z)}{\zeta^z} \{ \psi(z-1) - \log \zeta \}.$$

27. Shew that

$$(i) \Gamma(z) = \sqrt{\left\{ B\left(z, \frac{1}{2}\right) \frac{\Gamma(2z)}{2^{2z-1}} \right\}};$$

$$(ii) \Gamma(z) = \frac{2^{2z} \left\{ \Gamma(2^n z) \right\}}{2^{nz-1+2^{-n}} \prod_{r=1}^n 2^{2^r} \left\{ B(2^{r-1}z, \frac{1}{2}) \right\}};$$

$$(iii) \Gamma(z) = 2^z e^{-z} \prod_{r=1}^\infty 2^{2^r} \left\{ B(2^{r-1}z, \frac{1}{2}) \right\}.$$

28. Shew that

$$\frac{\Gamma(\alpha)\Gamma(\beta)}{\Gamma(\alpha+\gamma)\Gamma(\beta-\gamma)} = \prod_{n=0}^\infty \left\{ \left(1 + \frac{\gamma}{\alpha+n}\right) \left(1 - \frac{\gamma}{\beta+n}\right) \right\}.$$

29. If $R(\gamma - \alpha - \beta) > 0$, prove

$$F(\alpha, \beta, \gamma, 1) = \prod_{n=0}^\infty \left\{ \left(1 - \frac{\alpha}{\gamma+n}\right) \left(1 + \frac{\alpha}{\gamma - \alpha - \beta + n}\right) \right\}.$$

30. If α and β are real, shew that

$$\left\{ \frac{\Gamma(\alpha)}{|\Gamma(\alpha+i\beta)|} \right\}^2 = \prod_{n=0}^\infty \left\{ 1 + \frac{\beta^2}{(\alpha+n)^2} \right\}.$$

31. Shew that, if $z \neq -1, -2, -3, \dots$,

$$\psi(z) + \gamma = \sum_{n=0}^\infty \left(\frac{1}{n+1} - \frac{1}{z+n+1} \right);$$

deduce that

$$\psi\left(\frac{1}{2}\right) + \gamma = 2 - 2 \log 2.$$

32. If $0 < R(z) < 1$, shew that $\int_0^\infty e^{-it} t^{z-1} dt$ is holomorphic in z , and that

$$\Gamma(z) = e^{\frac{i\pi}{2}z} \int_0^\infty e^{-it} t^{z-1} dt.$$

[Integrate $e_{-z}\zeta^{z-1}$ round the contour of Fig. 52, § 51, and apply the inequality $\frac{\sin \theta}{\theta} \cong \frac{2}{\pi}$ to the circular part of the contour.]

33. If $0 < R(z) < 1$, shew that

$$\Gamma(z) = e^{-\frac{i\pi}{2}z} \int_0^\infty e^{it} t^{z-1} dt.$$

34. If $0 < R(z) < 1$, shew that

$$\int_0^\infty \cos t \cdot t^{z-1} dt = \Gamma(z) \cos\left(\frac{\pi z}{2}\right).$$

35. If $-1 < R(z) < 1$, shew that

$$\int_0^\infty \sin t \cdot t^{z-1} dt = \Gamma(z) \sin\left(\frac{\pi z}{2}\right).$$

36. If $0 < R(z) < 1$, shew that

$$\int_0^\infty \frac{\cos t}{t^z} dt = \frac{\pi}{2\Gamma(z) \cos\left(\frac{\pi z}{2}\right)}.$$

37. If $0 < R(z) < 2$, shew that

$$\int_0^{\infty} \frac{\sin t}{t^z} dt = \frac{\pi}{2\Gamma(z) \sin\left(\frac{\pi z}{2}\right)}.$$

38. If $R(z) > 0$, shew that

$$(i) \frac{1}{z} = \int_0^1 t^{z-1} dt = \int_0^{\infty} e^{-tz} dt;$$

$$(ii) \log z = \int_0^1 \frac{t^{z-1} - 1}{\log t} dt = \int_0^{\infty} \frac{e^{-t} - e^{-tz}}{t} dt;$$

$$(iii) \frac{n!}{z^{n+1}} = (-1)^n \int_0^1 t^{z-1} (\log t)^n dt = \int_0^{\infty} e^{-tz} t^n dt.$$

39. If $r > 0$, $-\pi/2 < \theta < \pi/2$, shew that

$$(i) \log r = \int_0^{\infty} \frac{e^{-t} - e^{-tr \cos \theta} \cos(tr \sin \theta)}{t} dt;$$

$$(ii) \theta = \int_0^{\infty} \frac{e^{-t \cos \theta} \sin(t \sin \theta)}{t} dt.$$

40. If $-\pi < \theta < \pi$, shew that

$$(i) \log\left(2 \cos \frac{\theta}{2}\right) = \int_0^{\infty} \frac{e^{-t}}{t} \{1 - e^{-t \cos \theta} \cos(t \sin \theta)\} dt;$$

$$(ii) \frac{\theta}{2} = \int_0^{\infty} \frac{e^{-t}}{t} e^{-t \cos \theta} \sin(t \sin \theta) dt.$$

[Put $z = 1 + e^{i\theta}$ in *Example 38*, (ii).]

41. Prove $\frac{1}{2} \log 2 = \int_0^{\infty} \frac{1 - \cos t}{t e^t} dt$.

42. If $R(z) > -1$, shew that

$$\psi(z) + \gamma = \int_0^1 \frac{1-t^z}{1-t} dt = \int_0^{\infty} \frac{e^{-t} - e^{-(z+1)t}}{1-e^{-t}} dt.$$

$$\begin{aligned} \left[\int_0^1 \frac{1-t^z}{1-t} dt = \int_0^1 (1-t^z) (1+t+t^2+\dots+t^n+\frac{t^{n+1}}{1-t}) dt \right. \\ \left. = \sum_0^n \left(\frac{1}{n+1} - \frac{1}{z+n+1} \right) + \int_0^1 \frac{t-t^{z+1}}{1-t} t^n dt. \right. \end{aligned}$$

Also, if M is the maximum value of $\left| \frac{t-t^{z+1}}{1-t} \right|$ for $0 \leq t \leq 1$,

$$\left| \int_0^1 \frac{t-t^{z+1}}{1-t} t^n dt \right| \leq \frac{M}{n+1}.$$

Now make n tend to infinity, and use *Example 31*.]

43. If $z \neq 0, -1, -2, \dots$, prove

$$\log z + \gamma = \sum_{n=0}^{\infty} \left\{ \frac{1}{n+1} - \log \left(1 + \frac{1}{z+n} \right) \right\};$$

deduce that $\psi(z) - \log z = \sum_{n=0}^{\infty} \left\{ \log \left(1 + \frac{1}{z+n} \right) - \frac{1}{z+n+1} \right\}$.

44. If $R(z) > -1$, shew that

$$\psi(z) = \int_0^{\infty} \left\{ \frac{e^{-t}}{t} - \frac{e^{-t(z+1)}}{1-e^{-t}} \right\} dt.$$

$$\begin{aligned} & \int_0^\infty \left\{ \frac{e^{-t}}{t} - \frac{e^{-t(z+1)}}{1-e^{-t}} \right\} dt \\ &= \int_0^\infty \left\{ \left(\frac{e^{-t}-e^{-tz}}{t} \right) + \left(\frac{e^{-tz}-e^{-t(z+1)}}{t} \right) + \dots + \left(\frac{e^{-t(z+n)}-e^{-t(z+n+1)}}{t} \right) + \frac{e^{-t(z+n+1)}}{t} \right\} dt \\ & \quad - e^{-t(z+1)} - e^{-t(z+2)} - \dots - e^{-t(z+n+1)} - \frac{e^{-t(z+n+2)}}{1-e^{-t}} \\ &= \log z + \sum_0^n \left\{ \log \left(1 + \frac{1}{z+n} \right) - \frac{1}{z+n+1} \right\} + \int_0^\infty \left\{ \frac{e^{-t(z+n+1)}}{t} - \frac{e^{-t(z+n+2)}}{1-e^{-t}} \right\} dt. \end{aligned}$$

Now make n tend to infinity, and use *Example 43*.]

45. Prove $\gamma = \int_0^\infty \left(\frac{1}{e-t} - \frac{1}{te^t} \right) dt$.

46. If $0 < R(z) < 1$, prove

(i) $\pi \cot \pi z = \int_0^1 \frac{t^{z-1} - t^{-z}}{1-t} dt$;

(ii) $\log(\sin \pi z) = \int_0^1 \frac{t^{z-1} + t^{-z} - 2t^{-1/2}}{(1-t) \log t} dt$.

47. If $R(z) > -1$, prove

$$\psi(z) = \int_0^\infty \left\{ e^{-t} - (1+t)^{-(z+1)} \right\} \frac{dt}{t};$$

deduce

$$\gamma = \int_0^\infty \left(\frac{1}{1+t} - e^{-t} \right) \frac{dt}{t}.$$

$$\begin{aligned} \int_0^\infty \left\{ e^{-t} - (1+t)^{-(z+1)} \right\} \frac{dt}{t} &= \int_0^\infty \left\{ \frac{e^{-t}}{t} - \frac{e^{-t(z+1)}}{1-e^{-t}} \right\} dt \\ & \quad + \int_0^\infty \left\{ \frac{e^{-t(z+1)} - e^{-t}}{1-e^{-t}} \right\} dt - \int_0^\infty \frac{(1+t)^{-(z+1)} - (1+t)^{-1}}{t} dt \\ & \quad + \int_0^\infty \left\{ \frac{e^{-t}}{1-e^{-t}} - \frac{1}{t(1+t)} \right\} dt. \end{aligned}$$

Apply the transformation $1+t=e^t$ to the third of these integrals, and use *Ex. 44*.]

48. If $R(z) > 0$, shew that

(i) $\log \Gamma(z) = \int_0^\infty \left\{ (z-1)e^{-t} + \frac{e^{-tz} - e^{-t}}{1-e^{-t}} \right\} \frac{dt}{t}$;

(ii) $\log \Gamma(z) = \int_0^1 \left\{ \frac{1-t^{z-1}}{1-t} - (z-1) \right\} \frac{dt}{\log t}$;

(iii) $\log \Gamma(z) = \int_0^\infty \left\{ e^{-t}(z-1) + \frac{(1+t)^{-z} - (1+t)^{-1}}{\log(1+t)} \right\} \frac{dt}{t}$.

49. If $R(z_1) > -1$, $R(z_2) > -1$, $R(z_1+z_2) > -1$, shew that

$$\log \frac{\Gamma(z_1+z_2+1)}{\Gamma(z_1+1)\Gamma(z_2+1)} = - \int_0^1 \frac{(1-t^{z_1})(1-t^{z_2})}{1-t} \frac{dt}{\log t}$$

50. If $R(z_1) > -1$, $R(z_1+z_2) > -1$, $R(z_1+z_3) > -1$, $R(z_1+z_2+z_3) > -1$, shew that

$$\log \frac{\Gamma(z_1+z_2+z_3+1)\Gamma(z_1+1)}{\Gamma(z_1+z_2+1)\Gamma(z_1+z_3+1)} = - \int_0^1 \frac{t^{z_1}(1-t^{z_2})(1-t^{z_3})}{1-t} \frac{dt}{\log t}$$

CHAPTER IX.

INTEGRALS OF MEROMORPHIC AND MULTIFORM
FUNCTIONS: ELLIPTIC INTEGRALS.

64. Integrals of Meromorphic Functions. If $f(z)$ is holomorphic in a simply-connected region C , $F(z) = \int_{z_0}^z f(z) dz$ is holomorphic in that region, provided that the path of integration lies entirely within C . If, however, the region C contains one or more poles of $f(z)$, the value of $F(z)$ will not necessarily be independent of the path of integration, and $F(z)$ may be a multiform function. Each branch of $F(z)$ will be holomorphic in a simply-connected region containing no singularity of $f(z)$. The path of integration, of course, must not pass through a singularity of $f(z)$.

For example, consider the integral $\int_1^z z^{-1} dz$ taken along the

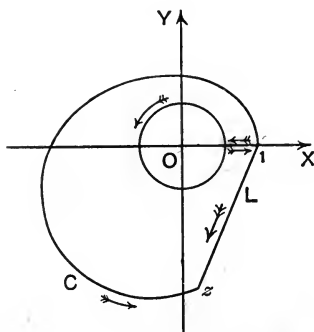

FIG. 66.

path C of Fig. 66 from 1 to z . This path can be replaced by a positive loop from 1 round O and the straight line L from 1 to z .

The integrals along the straight parts of the loop cancel, while the circular part gives the value $2\pi i$; hence

$$\int_C \frac{dz}{z} = \int_L \frac{dz}{z} + 2\pi i.$$

Now any path from 1 to z can be replaced by a number of positive or negative loops from 1 about O and the line L. Hence the most general value of $\text{Log } z = \int_1^z z^{-1} dz$ is

$$\int_L \frac{dz}{z} + 2n\pi i = \log z + 2n\pi i,$$

where n is an integer. This agrees with the results of § 18.

Similarly, if a uniform function $f(z)$ has poles a_1, a_2, \dots , of residues R_1, R_2, \dots , in C, the path from z_0 to z can be replaced by a series of loops from z_0 about a_1, a_2, \dots , and a straight line L from z_0 to z . The most general value of the integral will then be

$$\int_L f(z) dz + 2\pi i(m_1 R_1 + m_2 R_2 + \dots),$$

where m_1, m_2, \dots , are integers. If, however, the residue at the pole is zero, the integral round the corresponding loop is zero, so that the integral is uniform in the domain of the pole. Thus

$\int_z^\infty z^{-2} dz = z^{-1}$ is a meromorphic function throughout the plane.

Example. Verify, by integrating round suitable loops, that

$$\tan^{-1} z = \int_0^z \frac{dz}{1+z^2} = \frac{1}{2i} \log \frac{1+iz}{1-iz} + m\pi,$$

where m is an integer.

65. Integrals of Multiform Functions. If the path of integration of a multiform function $f(z)$ does not pass through any singularity of $f(z)$, $f(z)$ will vary continuously along the path, and the definition of § 26 still holds for the integral. As in the previous section, the values of $F(z) = \int_{z_0}^z f(z) dz$ may differ with the path; and the path can be replaced by a series of loops about the singular points, followed by a straight line from z_0 to z .

Example 1. Let $F(z) = \int_1^z z^{-1/2} dz$, where the initial value of $z^{-1/2}$ is unity; the integrand has branch-points at the origin and infinity.

The loop about $z = \infty$ consists of the line AB (Fig. 67), where A and B are the points $z=1$ and $z=R$ (R large) respectively, the circle BCD or $|z|=R$

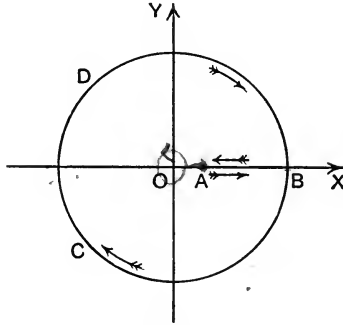

FIG. 67.

described negatively, and the line BA. But this path can be deformed into a negative loop from A round O. Hence we need only consider the effect of the loops about O.

Let L denote the positive loop from 1 about O; then, since $\lim_{z \rightarrow 0} z \times z^{-1/2} = 0$, the integral round the circular part of L tends to zero with the radius (§ 30, Th. II.). Also, as z describes the circle, $\text{amp } z$ increases by 2π ; so that $\text{amp } z^{-1/2}$ decreases by π . Thus $z^{-1/2}$ changes from $1/\sqrt{x}$ to $-1/\sqrt{x}$; hence

$$\int_L \frac{dz}{\sqrt{z}} = \int_1^0 \frac{dx}{\sqrt{x}} + \int_0^1 \frac{dx}{-\sqrt{x}} = -4.$$

A description of L^{-1} , by which we denote the loop L described negatively, gives the same result.

Since $z^{-1/2}$ returns to A with the value -1 , a second description of L or L^{-1} will give the value 4, and bring $z^{-1/2}$ back to A with the value $+1$.

Thus an even number of loops gives the value 0, and brings $z^{-1/2}$ back to A with the value $+1$; while an odd number of loops gives the value -4 , and brings $z^{-1/2}$ back to A with the value -1 . Hence the general value of $F(z)$ is

$$2\{-1 + (-1)^m\} + (-1)^m w,$$

where w denotes the integral $\int_1^z z^{-1/2} dz$ along a straight line from A to z , with $+1$ as the initial value of $z^{-1/2}$.

Example 2. Let $F(z) = \int_0^z f(z) dz$, where $f(z) = 1/\sqrt{1-z^2}$ and $f(z) = 1$ initially. Also let A and B denote positive loops round the branch points $+1$ and -1 respectively.

Since
$$\lim_{z \rightarrow 1} (z-1) \frac{1}{\sqrt{1-z^2}} = 0,$$

the value of the integral round A or A^{-1} is C, where

$$C = 2 \int_0^1 \frac{dx}{\sqrt{1-x^2}},$$

and $f(z)$ returns to O with the value -1 . Two successive integrals round A or A^{-1} give the value zero, and bring $f(z)$ back to O with the value $+1$. Similarly B or B^{-1} gives the integral $-C$, and two successive descriptions give the integral zero. Successive descriptions of A and B or of B and A give $2C$ or $-2C$, while $f(z)$ regains its initial value $+1$ at O .

Accordingly, if w denotes $\int_0^z f(z)dz$ taken along a straight line from O to z , with initial value $+1$, the general value of $F(z)$ is $mC + (-1)^m w$, where m is an integer.

To evaluate C we proceed as follows: make $f(z)$ uniform by a cross-cut from -1 to $+1$, and choose the branch of $f(z)$ which has the value $+1$ at the origin on the lower side of the cross-cut. Then, at a point on the x -axis to the right of $z=1$, amp $\sqrt{(1-z^2)} = \pi/2$; so that

$$f(z) = \frac{1}{\sqrt{(x^2-1)}e^{i\pi/2}} = \frac{1}{i\sqrt{(x^2-1)}}$$

where $\sqrt{(x^2-1)}$ is positive. Hence

$$\lim_{z \rightarrow \infty} \frac{z}{\sqrt{(1-z^2)}} = \frac{1}{i};$$

so that $\int f(z)dz$, taken positively round an infinite circle, has the value 2π .

But the great circle can be deformed into the loops A and B taken successively, and the value of the integral is then $2C$; hence $C = \pi$.

Thus the general value of $\sin^{-1}z$ is given by

$$\sin^{-1}z = \int_0^z \frac{dz}{\sqrt{(1-z^2)}} = (-1)^m w + m\pi.$$

It follows that the inverse function $z = \sin w$ has the property

$$\sin \{m\pi + (-1)^m w\} = \sin w.$$

Again, since $\int_0^{-z} f(z)dz = -w$, it follows that $-z = \sin(-w)$. But $z = \sin w$; thus $\sin(-w) = -\sin w$, so that $\sin w$ is an odd function. Many of the other properties of the sine function could also be deduced from those of the integral

$$\int_0^z \frac{dz}{\sqrt{(1-z^2)}}.$$

66. Legendre's First Normal Elliptic Integral. Let

$$F(z) = \int_0^z f(z)dz,$$

where $f(z) = \{(1-z^2)(1-k^2z^2)\}^{-\frac{1}{2}}$, and k is a positive proper fraction. The initial value of $f(z)$ at $z=0$ is taken to be $+1$. The integrand has four branch-points, $+1, -1, +1/k, -1/k$.

The loop A from O about 1 gives the integral $2K$, where $K = \int_0^1 \frac{dx}{\sqrt{\{(1-x^2)(1-k^2x^2)\}}}$, and $f(z)$ returns to O with the value -1 . Two successive integrations round A give the value 0 , and

bring $f(z)$ back to O with the value 1. Similarly the loop B about -1 gives the integral $-2K$, and two successive integrations round B give the value 0. Successive integrations round A and B or round B and A give the values $4K$ and $-4K$ respectively, and $f(z)$ regains the value $+1$ at O .

Since a straight line cannot be drawn from O to $1/k$ without passing through the singularity $+1$, the loop L_1 about $1/k$ is formed by means of a curved line (Fig. 68) above the x -axis and

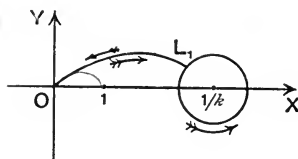

FIG. 68.

a small circle about $1/k$. This loop can be deformed into the contour (Fig. 69) consisting of:

- (i) the x -axis from O to $1 - \epsilon$;
- (ii) a small semi-circle c of centre 1 and radius ϵ above the x -axis, described negatively;
- (iii) the x -axis from $1 + \epsilon$ to $1/k - \epsilon$;
- (iv) a small circle C of centre $1/k$ and radius ϵ , described positively;
- (v) the x -axis from $1/k - \epsilon$ to $1 + \epsilon$;
- (vi) the semi-circle c described positively;
- (vii) the x -axis from $1 - \epsilon$ to O .

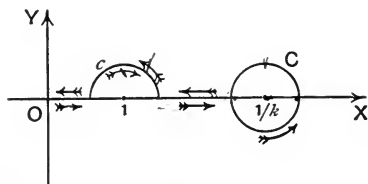

FIG. 69.

Since $\lim_{z \rightarrow 1} (z-1)f(z) = 0$ and $\lim_{z \rightarrow 1/k} (z-1/k)f(z) = 0$, the integrals along (ii), (iv), and (vi) tend to zero with ϵ .

The integral along (i) gives K . As z passes round c , $\text{amp}(z-1)$

decreases by π , and $(1-x)$ changes to $(x-1)e^{-i\pi}$; hence the integral along (iii) is

$$\frac{1}{e^{-i\pi/2}} \int_1^{1/k} \frac{dx}{\sqrt{\{(x^2-1)(1-k^2x^2)\}}} = iK',$$

where

$$K' = \int_1^{1/k} \frac{dx}{\sqrt{\{(x^2-1)(1-k^2x^2)\}}}.$$

Again, as z passes round C , $\text{amp}(z-1/k)$ increases by 2π , and $(1-kx)$ becomes $(1-kx)e^{2i\pi}$; hence (v) gives the integral

$$\frac{1}{e^{i\pi/2}} \int_{1/k}^1 \frac{dx}{\sqrt{\{(x^2-1)(1-k^2x^2)\}}} = iK'.$$

Finally, as z passes round c , $\text{amp}(z-1)$ increases by π , and $(x-1)$ becomes $(1-x)e^{i\pi}$; so that (vii) gives the integral

$$\frac{1}{e^{i\pi}} \int_1^0 \frac{dx}{\sqrt{\{(1-x^2)(1-k^2x^2)\}}} = K.$$

Thus the value of the integral round the loop is $2K+2iK'$, and $f(z)$ returns to O with the value -1 .

It can be proved in a similar manner that the integral round the loop L_2 (Fig. 70) is $2K-2iK'$. This follows more simply,

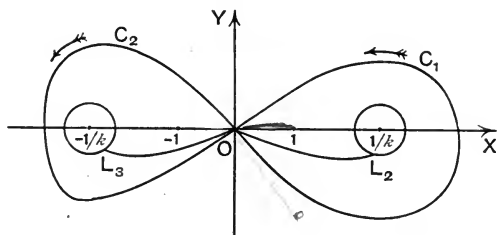

FIG. 70.

however, from the fact that L_2 can be replaced by A, L_1, A^{-1} , taken in succession: the value of the integral along this contour is then $2K - (2K + 2iK') + 2K = 2K - 2iK'$.

Similarly, the contour C_1 (Fig. 70) can be replaced by A and L_1 taken in succession; so that the integral round C_1 has the value $2K - (2K + 2iK') = -2iK'$, and $f(z)$ returns to O with the value $+1$.

Finally, the integrals round the loop L_3 and the curve C_2 have the values $-(2K + 2iK')$ and $2iK'$ respectively.

Hence, if w denotes the integral $\int_0^z f(z) dz$ taken along a straight line from O to z , with the initial value $+1$ at O , the

general value of $F(z)$ is $2mK + 2niK' + (-1)^m w$, where m and n are integers.

The value of the integral when z is infinite can be found as follows. Let the integral be taken round the contour (Fig. 71)

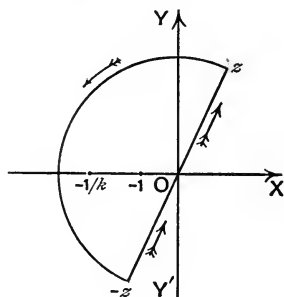

FIG. 71.

consisting of: (i) the straight line from O to z ; (ii) a semi-circle of centre O from z to $-z$; (iii) the line from $-z$ to O . Since this contour is equivalent to the contour C_2 (Fig. 70), the integral has the value $2iK'$. But the integral along (ii) tends to zero when z tends to infinity (§ 30, Th. I.), and $\int_{-z}^0 f(z) dz = \int_0^z f(z) dz$, since the final value of $f(z)$ is equal to its initial value. Therefore, when z tends to infinity, $\int_0^z f(z) dz$ tends to the value iK' ; so that

$$\int_0^\infty f(z) dz = iK' + 2mK + 2niK'.$$

If in the integral

$$K' = \int_1^{1/k} \frac{dx}{\sqrt{\{(x^2-1)(1-k^2x^2)\}}}$$

we put $y = \sqrt{(1-k^2x^2)}/k'$, where $k' = \sqrt{(1-k^2)}$, we obtain

$$K' = \int_0^1 \frac{dy}{\sqrt{\{(1-y^2)(1-k'^2y^2)\}}}.$$

It follows that K' is the same function of k' that K is of k .

Inversion of the Elliptic Integral. In Example 2 of the previous section we deduced from the properties of the integral

$w = \int_0^z \frac{dz}{\sqrt{(1-z^2)}}$ various properties of the inverse function $z = \sin w$.

Similarly, if $w = \int_0^z \frac{dz}{\sqrt{\{(1-z^2)(1-k^2z^2)\}}}$, z can be regarded as a function of w , and from the properties of the integral those of the function can be deduced. We shall here make two assumptions: (i) that the function exists for all real or complex values of w ; and (ii) that the function is single-valued. These assumptions will be justified in Chapter XI. The function is denoted by $z = \operatorname{sn} w$: from the general value of the integral it follows that

$$\operatorname{sn} w = \operatorname{sn} \{2mK + 2niK' + (-1)^m w\}.$$

Accordingly, $\operatorname{sn} w$ has two periods, $4K$ and $2iK'$, the one purely real and the other purely imaginary, and $\operatorname{sn}(2K - w) = \operatorname{sn} w$.

Again, since $\int_0^{-z} f(z) dz = -\int_0^z f(z) dz = -w$, it follows that $-z = \operatorname{sn}(-w) = -\operatorname{sn} w$; so that $\operatorname{sn} w$ is odd. The properties of the integral also give:

$$\operatorname{sn} 0 = 0, \operatorname{sn} K = 1, \operatorname{sn}(K + iK') = \operatorname{sn}(K - iK') = 1/k, \operatorname{sn} iK' = \infty.$$

Instead of $\operatorname{sn} w$ the notation $\operatorname{sn}(w, k)$ is frequently employed: k is called the *Modulus* and k' the *Complementary Modulus* of $\operatorname{sn}(w, k)$.

Example. Shew that $K' = \log(4/k) + \phi(k)$, where $\phi(k)$ tends to zero with k . We have

$$\begin{aligned} K' - \log\left(\frac{1+k'}{k}\right) &= \int_1^{1/k} \frac{dx}{\sqrt{\{(x^2-1)(1-k^2x^2)\}}} - \int_1^{1/k} \frac{dx}{\sqrt{(x^2-1)}} \\ &= \int_k^1 \left\{ \frac{1}{\sqrt{(1-y^2)}} - 1 \right\} \frac{dy}{\sqrt{(y^2-k^2)}}, \end{aligned}$$

where $y = kx$.

Hence

$$\begin{aligned} \lim_{k \rightarrow 0} \left\{ K' - \log\left(\frac{1+k'}{k}\right) \right\} &= \int_0^1 \left\{ \frac{1}{\sqrt{(1-y^2)}} - 1 \right\} \frac{dy}{y} \\ &= \left[-\log\{1 + \sqrt{(1-y^2)}\} \right]_0^1 \\ &= \log 2; \end{aligned}$$

from which the required theorem follows.

67. The Weierstrassian Elliptic Integral. Let

$$w - w_0 = \int_{z_0}^z f(z) dz,$$

where $f(z) = \{4(z - e_1)(z - e_2)(z - e_3)\}^{-\frac{1}{2}}$: here $w = w_0$ corresponds to $z = z_0$, and one of the two values of $f(z_0)$ is selected as initial

value. There are four branch-points of $f(z)$ (Fig. 72), e_1, e_2, e_3 , and ∞ . The loop L about ∞ , however, consisting of the line from

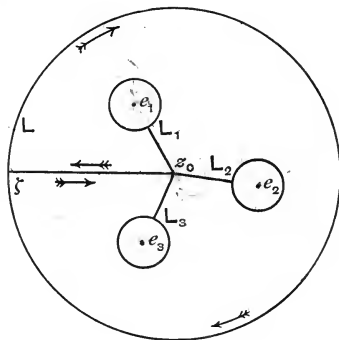

FIG. 72.

z_0 to ξ and a large circle described negatively, can be replaced by the loops L_1, L_2, L_3 , about e_1, e_2, e_3 , described negatively in succession; so that it is only necessary to consider the effects of these

three loops. Let $A_1 = \int_{z_0}^{e_1} f(z) dz$, $A_2 = \int_{z_0}^{e_2} f(z) dz$, $A_3 = \int_{z_0}^{e_3} f(z) dz$;

then integrals round the loops L_1, L_2, L_3 , or $L_1^{-1}, L_2^{-1}, L_3^{-1}$, give the values $2A_1, 2A_2, 2A_3$, respectively. Two successive integrations round a loop give the value zero. Successive integrations round loops L_r and L_s give the value $2A_r - 2A_s$. Again, the description of an even number of loops brings $f(z)$ back to z_0 with its initial value $f(z_0)$, while an odd number brings it back with the value $-f(z_0)$.

Hence, if I denotes the integral $\int_{z_0}^z f(z) dz$ taken along a straight line from z_0 to z , the general value of the integral is given by

$$w - w_0 = 2n_1A_1 + 2n_2A_2 + 2n_3A_3 + (-1)^{n_1+n_2+n_3}I,$$

where n_1, n_2, n_3 are integers such that $n_1 + n_2 + n_3$ has the value 0 or 1 according as the number of loops described is even or odd.

Now let $n_1 = -m_2$, $n_3 = -m_1$, so that either $n_2 = m_1 + m_2$ or $n_2 = m_1 + m_2 + 1$; then either

$$w - w_0 = -2m_2(A_1 - A_2) - 2m_1(A_3 - A_2) + I$$

or $w - w_0 = -2m_2(A_1 - A_2) - 2m_1(A_3 - A_2) + 2A_2 - I.$

Again, if $\omega_1 = \int_{e_3}^{e_2} f(z) dz$ and $\omega_2 = \int_{e_1}^{e_2} f(z) dz$,

$A_2 - A_3 = \omega_1$ and $A_2 - A_1 = \omega_2$;

hence either $w = w_0 + 2m_1\omega_1 + 2m_2\omega_2 + I$

or $w = w_0 + 2m_1\omega_1 + 2m_2\omega_2 + 2A_2 - I$.

Thus the inverse function $z = \phi(w)$ is doubly-periodic, with periods $2\omega_1$ and $2\omega_2$.

Next, let the integral be taken along the contour consisting of the loops L, L_3, L_2, L_1 , taken in succession. This curve encloses no singular point, so that the value of the integral is zero. But the integral round the large circle tends to zero as the radius tends to infinity; hence

$$0 = 2 \int_{z_0}^{\infty} f(z) dz - 2A_3 + 2A_2 - 2A_1;$$

so that $\int_{z_0}^{\infty} f(z) dz = A_3 - A_2 + A_1$.

Now take $w_0 = \int_{z_0}^{\infty} f(z) dz = -A_3 + A_2 - A_1$; then $w = \int_z^{\infty} f(z) dz$.

Hence, if $z = e_1$,

$$w = 2m_1\omega_1 + 2m_2\omega_2 - A_3 + A_2 - A_1 + A_1 = 2m_1\omega_1 + 2m_2\omega_2 + \omega_1$$

or $w = 2m_1\omega_1 + 2m_2\omega_2 - A_3 + A_2 - A_1 + 2A_2 - A_1$
 $= 2m_1\omega_1 + 2m_2\omega_2 + 2\omega_2 + \omega_1$.

Therefore $e_1 = \phi(\omega_1)$. Similarly $e_2 = \phi(\omega_1 + \omega_2)$ and $e_3 = \phi(\omega_2)$.

Again, if $W = w_0 + I$,

$$w = 2m_1\omega_1 + 2m_2\omega_2 + W$$

or $w = 2m_1\omega_1 + 2m_2\omega_2 + 4A_2 - 2A_3 - 2A_1 - W$
 $= 2(m_1 + 1)\omega_1 + 2(m_2 + 1)\omega_2 - W$.

Thus $\phi(w)$ is an even function of w . It will be shewn in Chapter X. that $\phi(w)$ is Weierstrass's Elliptic Function $\wp(w)$. It should be noticed that the signs of the two periods $2\omega_1$ and $2\omega_2$ depend on the initial value selected for $f(z_0)$.

68. Elliptic Integrals in General. Any integral of the type

$\int R(z, \sqrt{Z}) dz$, where $R(x, y)$ is a rational function of x and y and Z is a polynomial of the third or fourth degree in z with real coefficients and no repeated factors, is called an Elliptic Integral.

When Z is a cubic the integral can be transformed into an integral in which Z is a quartic as follows.

Let $Z = (z - \beta)(az^2 + bz + c)$, where β, a, b, c , are real; then, if $z - \beta = \xi^2$,

$$\int R(z, \sqrt{Z}) dz = \int R[\beta + \xi^2, \xi \sqrt{\{a(\beta + \xi^2)^2 + b(\beta + \xi^2) + c\}}] 2\xi d\xi,$$

which is an integral of the required form.

Again, let $R(x, y) = P(x, y)/Q(x, y)$, where $P(x, y)$ and $Q(x, y)$ are polynomials in x and y ; then, since $(\sqrt{Z})^{2p}$, where p is a positive integer, is a polynomial in z , we can write

$$P(z, \sqrt{Z}) = K(z) + L(z)\sqrt{Z}, \quad Q(z, \sqrt{Z}) = M(z) + N(z)\sqrt{Z},$$

where $K(z), L(z), M(z), N(z)$, are polynomials in z .

Now multiply numerator and denominator by $M(z) - N(z)\sqrt{Z}$; then

$$R(z, \sqrt{Z}) = U(z) + V(z)\sqrt{Z},$$

where $U(z)$ and $V(z)$ are rational in z .

But $U(z)$ can be integrated by elementary methods. Hence we need only consider integrals of the type

$$\int V(z)\sqrt{Z} dz \quad \text{or} \quad \int \frac{S(z)}{\sqrt{Z}} dz,$$

where $S(z)$ is rational in z .

Again, by the method of partial fractions, $S(z)$ can be put in the form

$$A_0 + A_1z + A_2z^2 + \dots + A_nz^n + \Sigma \left\{ \frac{B_0}{z - \alpha} + \frac{B_1}{(z - \alpha)^2} + \dots + \frac{B_p}{(z - \alpha)^p} \right\}.$$

Hence the integral $\int \{S(z)/\sqrt{Z}\} dz$ can be expressed linearly in terms of integrals of the types

$$\int \frac{z^n}{\sqrt{Z}} dz \quad \text{and} \quad \int \frac{dz}{(z - \alpha)^n \sqrt{Z}}.$$

$$\text{Now} \quad \frac{d}{dz}(z^m \sqrt{Z}) = \frac{c_0 z^{m+3} + c_1 z^{m+2} + \dots + c_4 z^{m-1}}{\sqrt{Z}};$$

so that $\int \frac{z^n}{\sqrt{Z}} dz$ can be expressed in terms of the four integrals

$$\int \frac{z^3}{\sqrt{Z}} dz, \quad \int \frac{z^2}{\sqrt{Z}} dz, \quad \int \frac{z}{\sqrt{Z}} dz, \quad \int \frac{dz}{\sqrt{Z}}.$$

$$\text{But} \quad \frac{d}{dz} \sqrt{Z} = \frac{4az^3 + 3bz^2 + 2cz + d}{2\sqrt{Z}},$$

where $Z = az^4 + bz^3 + cz^2 + dz + e$; therefore $\int \frac{z^n dz}{\sqrt{Z}}$ can be expressed in terms of the three integrals

$$\int \frac{z^2 dz}{\sqrt{Z}}, \int \frac{z dz}{\sqrt{Z}}, \int \frac{dz}{\sqrt{Z}}.$$

Similarly, since

$$\frac{d}{dz} \frac{\sqrt{Z}}{(z-\alpha)^m} = \frac{d_0(z-\alpha)^4 + d_1(z-\alpha)^3 + d_2(z-\alpha)^2 + d_3(z-\alpha) + d_4}{(z-\alpha)^{m+1}\sqrt{Z}},$$

$\int \frac{dz}{(z-\alpha)^n \sqrt{Z}}$ can be expressed in terms of

$$\int \frac{dz}{(z-\alpha)\sqrt{Z}}, \int \frac{dz}{\sqrt{Z}}, \int \frac{(z-\alpha)dz}{\sqrt{Z}}, \int \frac{(z-\alpha)^2 dz}{\sqrt{Z}}.$$

Thus every Elliptic Integral can be expressed in terms of integrals of the types

$$\int \frac{dz}{\sqrt{Z}}, \int \frac{z dz}{\sqrt{Z}}, \int \frac{z^2 dz}{\sqrt{Z}}, \int \frac{dz}{(z-\alpha)\sqrt{Z}}.$$

Again, since imaginary factors of Z always occur in pairs, Z can always be written $a(z^2 + pz + q)(z^2 + rz + s)$, where p, q, r, s , are real. Now in the transformation $z = (f + g\xi)/(1 + \xi)$, let f and g be chosen so that the coefficient of ξ in each quadratic is zero; then Z will take the form

$$A \frac{(1 + m\xi^2)(1 + n\xi^2)}{(1 + \xi)^4}.$$

It is always possible to find real values for m and n . For

$$f + g = 2 \frac{q - s}{r - p}, \quad fg = \frac{ps - qr}{r - p};$$

so that f and g are the two roots of the quadratic equation

$$(r - p)f^2 + 2(s - q)f + (ps - qr) = 0.$$

Accordingly, if the roots are real, we must have

$$(s - q)^2 - (r - p)(ps - qr) > 0. \tag{A}$$

Now let the two equations

$$x^2 + px + q = 0, \quad x^2 + rx + s = 0, \tag{B}$$

have roots x_1, x_2 , and x_3, x_4 , respectively; so that

$$x_1 + x_2 = -p, \quad x_1 x_2 = q, \quad x_3 + x_4 = -r, \quad x_3 x_4 = s.$$

Then inequality (A) can be written

$$(x_1 - x_3)(x_1 - x_4)(x_2 - x_3)(x_2 - x_4) > 0.$$

This inequality holds if one at least of equations (B) has imaginary roots; for then the four factors consist of two pairs of conjugate complex quantities. Also, if both equations have real roots, the factors of Z can always be chosen so that

$$x_1 > x_2 > x_3 > x_4.$$

Thus the inequality holds in this case also. It follows that real values of f and g , and therefore of m and n , can always be found.

Accordingly, every Elliptic Integral can be expressed in terms of integrals of the types

$$\int \frac{\xi^2 d\xi}{\sqrt{\Omega}}, \quad \int \frac{\xi d\xi}{\sqrt{\Omega}}, \quad \int \frac{d\xi}{\sqrt{\Omega}}, \quad \int \frac{d\xi}{(\xi - \beta)\sqrt{\Omega}},$$

where $\Omega = (1 + m\xi^2)(1 + n\xi^2)$.

But
$$\int \frac{\xi d\xi}{\sqrt{\Omega}} = \frac{1}{2} \int \frac{d\xi^2}{\sqrt{\{(1 + m\xi^2)(1 + n\xi^2)\}}},$$

and this integral can be evaluated by elementary methods.

Also
$$\int \frac{d\xi}{(\xi - \beta)\sqrt{\Omega}} = \int \frac{(\xi + \beta)d\xi}{(\xi^2 - \beta^2)\sqrt{\Omega}}$$

$$= \beta \int \frac{d\xi}{(\xi^2 - \beta^2)\sqrt{\Omega}} + \frac{1}{2} \int \frac{d\xi^2}{(\xi^2 - \beta^2)\sqrt{\Omega}},$$

and the last integral can be evaluated by elementary methods.

Hence we need only consider the integrals

$$\int \frac{\xi^2 d\xi}{\sqrt{\Omega}}, \quad \int \frac{d\xi}{\sqrt{\Omega}}, \quad \int \frac{d\xi}{(\xi^2 - \beta^2)\sqrt{\Omega}}.$$

There are four cases to be considered (we assume $a^2 > b^2$):

- (i) $\Omega = (1 - a^2\xi^2)(1 - b^2\xi^2)$; (ii) $\Omega = (1 - a^2\xi^2)(1 + b^2\xi^2)$;
 (iii) $\Omega = (1 + a^2\xi^2)(1 - b^2\xi^2)$; (iv) $\Omega = (1 + a^2\xi^2)(1 + b^2\xi^2)$.

In case (i) put $\xi = x/a$, $k = b/a$; then the integrals are transformed into integrals of the forms

$$\int \frac{x^2 dx}{\sqrt{\{(1 - x^2)(1 - k^2 x^2)\}}}, \quad \int \frac{dx}{\sqrt{\{(1 - x^2)(1 - k^2 x^2)\}}},$$

$$\int \frac{dx}{(x^2 - v^2)\sqrt{\{(1 - x^2)(1 - k^2 x^2)\}}}.$$

In cases (ii), (iii), and (iv), make the substitutions

$$1 - a^2\xi^2 = x^2, \quad 1 - b^2\xi^2 = x^2, \quad \text{and} \quad 1 + b^2\xi^2 = 1/x^2,$$

respectively; then all these cases reduce to case (i).

Now
$$\int \frac{x^2 dx}{\sqrt{\{(1-x^2)(1-k^2x^2)\}}} = \frac{1}{k^2} \int \frac{dx}{\sqrt{\{(1-x^2)(1-k^2x^2)\}}} - \frac{1}{k^2} \int \sqrt{\left(\frac{1-k^2x^2}{1-x^2}\right)} dx.$$

Hence all Elliptic Integrals can be expressed in terms of Elliptic Integrals of the three types,

$$\int \frac{dx}{\sqrt{\{(1-x^2)(1-k^2x^2)\}}}, \quad \int \sqrt{\left(\frac{1-k^2x^2}{1-x^2}\right)} dx, \\ \int \frac{dx}{(x^2-v^2)\sqrt{\{(1-x^2)(1-k^2x^2)\}}}.$$

The three definite integrals,

$$\int_0^x \frac{dx}{\sqrt{\{(1-x^2)(1-k^2x^2)\}}}, \quad \int_0^x \sqrt{\left(\frac{1-k^2x^2}{1-x^2}\right)} dx, \\ \int_0^x \frac{dx}{(x^2-v^2)\sqrt{\{(1-x^2)(1-k^2x^2)\}}},$$

are called Legendre's Normal Integrals of the First, Second, and Third kinds.

Example. Prove

$$\int_0^1 \frac{3x^4+2x^2}{\sqrt{(x^4+x^2+1)}} dx = \sqrt{3} - \frac{2}{3} \int_0^{\sqrt{3/2}} \frac{dx}{\sqrt{\{(1-x^2)(1-\frac{8}{9}x^2)\}}}.$$

Since

$$\frac{d}{dx} x\sqrt{(x^4+x^2+1)} = \frac{3x^4+2x^2+1}{\sqrt{(x^4+x^2+1)}}, \\ \int_0^1 \frac{3x^4+2x^2}{\sqrt{(x^4+x^2+1)}} dx = \sqrt{3} - \int_0^1 \frac{dx}{\sqrt{(x^4+x^2+1)}}.$$

But

$$\int_0^1 \frac{dx}{\sqrt{(x^4+x^2+1)}} = \int_0^1 \frac{dx}{\sqrt{\{(x^2+x+1)(x^2-x+1)\}}} \\ = 2 \int_1^{\infty} \frac{dy}{\sqrt{\{(3y^2+1)(3+y^2)\}}}, \quad \text{where } x = \frac{y-1}{y+1}, \\ = \frac{2}{3} \int_0^{\sqrt{3/2}} \frac{dz}{\sqrt{\{(1-z^2)(1-\frac{8}{9}z^2)\}}}, \quad \text{where } y^2+3 = \frac{3}{z^2}.$$

Hence the required equation follows.

69. Complete Elliptic Integrals. If in the First and Second of Legendre's Normal Integrals the substitution $x = \sin \phi$ is made, they become

$$F(k, \phi) = \int_0^{\phi} \frac{d\phi}{\sqrt{(1-k^2 \sin^2 \phi)}}, \quad E(k, \phi) = \int_0^{\phi} \sqrt{(1-k^2 \sin^2 \phi)} d\phi,$$

respectively. In particular, if $\alpha=1$, then $\phi=\pi/2$, and these integrals become

$$K = F(k, \pi/2) = \int_0^{\pi/2} \frac{d\phi}{\sqrt{(1-k^2 \sin^2 \phi)}},$$

$$E = E(k, \pi/2) = \int_0^{\pi/2} \sqrt{(1-k^2 \sin^2 \phi)} d\phi,$$

which are known as Legendre's Complete Elliptic Integrals of the First and Second kinds. Similarly we write

$$K' = F(k', \pi/2), \quad E' = E(k', \pi/2).$$

These functions can be expressed as hypergeometric series in k and k' : for, since $k < 1$,

$$\begin{aligned} K &= \int_0^{\pi/2} \left(1 + \frac{1}{2}k^2 \sin^2 \phi + \frac{1 \cdot 3}{2 \cdot 4}k^4 \sin^4 \phi + \dots \right) d\phi \\ &= \frac{\pi}{2} \left\{ 1 + \left(\frac{1}{2}\right)^2 k^2 + \left(\frac{1 \cdot 3}{2 \cdot 4}\right)^2 k^4 + \dots \right\} = \frac{\pi}{2} F\left(\frac{1}{2}, \frac{1}{2}, 1, k^2\right). \end{aligned}$$

$$\text{Similarly } K' = \frac{\pi}{2} F\left(\frac{1}{2}, \frac{1}{2}, 1, k'^2\right), \quad E = \frac{\pi}{2} F\left(-\frac{1}{2}, \frac{1}{2}, 1, k^2\right),$$

$$\text{and } E' = \frac{\pi}{2} F\left(-\frac{1}{2}, \frac{1}{2}, 1, k'^2\right).$$

The numerical values of $K, E, K',$ and E' can be easily evaluated by means of these series, except when the value of k or k' , as the case may be, is nearly unity, in which case the convergence is slow.

Landen's Transformation. If in the integral $F(k, \phi)$ we make the substitution

$$\tan(\phi_1 - \phi) = k' \tan \phi \quad \text{or} \quad \tan \phi_1 = \sin 2\phi / (k_1 + \cos 2\phi),$$

where $k_1 = \frac{1-k'}{1+k'} = \frac{k}{(1+k')^2} k < k$, we obtain

$$d\phi_1 = \frac{1+k_1 \cos 2\phi}{1+2k_1 \cos 2\phi + k_1^2} 2d\phi,$$

$$\text{and } \sqrt{(1-k_1^2 \sin^2 \phi_1)} = \frac{1+k_1 \cos 2\phi}{\sqrt{(1+2k_1 \cos 2\phi + k_1^2)}};$$

$$\text{so that } F(k, \phi) = \frac{1+k_1}{2} F(k_1, \phi_1).$$

Thus the integral is expressed in terms of an integral of smaller modulus. In particular, if $\phi = \pi/2$, then $\phi_1 = \pi$, so that

$$F\left(k, \frac{\pi}{2}\right) = \frac{1+k_1}{2} \int_0^{\pi} \frac{d\phi}{\sqrt{(1-k_1^2 \sin^2 \phi)}} = (1+k_1) F\left(k_1, \frac{\pi}{2}\right).$$

Accordingly, if the modulus of k is nearly unity, the value of $F(k, \pi/2)$ can be deduced from that of $F(k_1, \pi/2)$ by means of this transformation.

Example. Prove $\int_0^{\pi/3} \frac{d\phi}{\sqrt{(1-\frac{8}{9}\sin^2\phi)}} = \frac{3}{4} \int_0^{\pi/2} \frac{d\theta}{\sqrt{(1-\frac{1}{4}\sin^2\theta)}}$;

and deduce from the example of § 68 that

$$\int_0^1 \frac{(3x^4 + 2x^2)dx}{\sqrt{(x^4 + x^2 + 1)}} = \sqrt{3} - \frac{1}{2}F\left(\frac{1}{2}, \frac{\pi}{2}\right).$$

70. Legendre's Relation. A relation can be established between the four quantities K, K', E, E' , as follows.

We have

$$\frac{dK}{dk} = \int_0^{\pi/2} \frac{k \sin^2 \phi d\phi}{(1-k^2 \sin^2 \phi)^{3/2}} = \frac{1}{k} \int_0^{\pi/2} \frac{d\phi}{(1-k^2 \sin^2 \phi)^{3/2}} - \frac{K}{k}.$$

But $k^2 \frac{d}{d\phi} \frac{\sin \phi \cos \phi}{\sqrt{(1-k^2 \sin^2 \phi)}} = \frac{-k'^2}{(1-k^2 \sin^2 \phi)^{3/2}} + \sqrt{(1-k^2 \sin^2 \phi)}.$

Therefore $0 = -k'^2 \int_0^{\pi/2} \frac{d\phi}{(1-k^2 \sin^2 \phi)^{3/2}} + E.$

Hence

$$\frac{dK}{dk} = \frac{E}{kk'^2} - \frac{K}{k}.$$

Accordingly, since $k^2 + k'^2 = 1,$

$$\frac{dK}{dk} = -\frac{E}{k^2 k'} + \frac{kK}{k^2}.$$

Therefore, interchanging k and $k',$ we have

$$\frac{dK'}{dk} = -\frac{E'}{kk'^2} + \frac{kK'}{k'^2}.$$

Again,

$$\begin{aligned} \frac{dE}{dk} &= \int_0^{\pi/2} \frac{-k \sin^2 \phi d\phi}{\sqrt{(1-k^2 \sin^2 \phi)}} \\ &= \frac{1}{k} \int_0^{\pi/2} \sqrt{(1-k^2 \sin^2 \phi)} d\phi - \frac{1}{k} \int_0^{\pi/2} \frac{d\phi}{\sqrt{(1-k^2 \sin^2 \phi)}} = \frac{E-K}{k}. \end{aligned}$$

Thus

$$\frac{dE}{dk} = \frac{-k'(E-K)}{k^2};$$

so that

$$\frac{dE'}{dk} = -\frac{k(E'-K')}{k'^2}.$$

Accordingly, if $W = KE' + K'E - KK', \frac{dW}{dk} = 0;$ therefore W is a constant.

Now consider the value of $(E-K)K'$ when k tends to zero. Since

$$E = \frac{\pi}{2} \left(1 - \frac{k^2}{4} + \dots \right) \quad \text{and} \quad K = \frac{\pi}{2} \left(1 + \frac{k^2}{4} + \dots \right),$$

$$E - K = -\frac{\pi}{4} k^2 + \dots$$

$$\text{Also} \quad K' = \int_0^{\pi/2} \frac{d\phi}{\sqrt{(1-k'^2 \sin^2 \phi)}} < \int_0^{\pi/2} \frac{d\phi}{\sqrt{(1-k'^2)}} = \frac{\pi}{2k}.$$

$$\text{Hence} \quad |(E-K)K'| < \left(\frac{\pi}{4} k^2 + \dots \right) \frac{\pi}{2k} = \frac{\pi^2}{8} k + \dots;$$

so that

$$\lim_{k \rightarrow 0} \{(E-K)K'\} = 0.$$

But, when $k=0$, $K = \pi/2$, and $E' = 1$; therefore

$$W = KE' + K'E - KK' = \frac{\pi}{2}.$$

COROLLARY. K and K' satisfy the equation

$$x(x-1) \frac{d^2y}{dx^2} + (2x-1) \frac{dy}{dx} + \frac{1}{4}y = 0,$$

where $x = k^2$. This equation is known as the differential equation of the Quarter Periods of the Jacobian Elliptic Functions.

EXAMPLES IX.

1. If $w = \int_0^z \frac{dz}{1+z^4}$, and if w_0 is any value of w corresponding to $z=z_0$, shew that the general value of w for $z=z_0$ is $w_0 + m\sqrt{2}\pi/4 + n\sqrt{2}\pi i/4$, where m and n are integers, such that $m+n$ is even.

2. If $w = \int_0^z \frac{1+z^2}{1+z^3} dz$, shew that, with the notation of the previous example, the general value of w is $w_0 + m\pi i/3 + n\pi\sqrt{3}/3$, where $m+n$ is even.

3. Find the most general value of $\int_0^1 \frac{dz}{\sqrt{(z^2+1)}}$ for any path of integration, where the initial value of the integrand is unity.

$$\text{Ans.} \quad n\pi i + (-1)^n \log(1+\sqrt{2}), \quad (n=0, \pm 1, \pm 2, \dots).$$

4. Prove $\int_0^1 \frac{dx}{\sqrt{(1-x^4)}} = \frac{1}{\sqrt{2}} F\left(\frac{1}{\sqrt{2}}, \frac{\pi}{2}\right)$. [Put $1-x^2=y^2$.]

5. Prove that, for the ellipse $x^2/a^2 + y^2/b^2 = 1$, the length of an arc measured from the point $(0, b)$ in the clockwise direction is $aE(e, \phi)$, where e is the eccentricity and $x = a \sin \phi$.

6. Prove that $\int_0^x \sqrt{\cos x} dx = 2\sqrt{2}E\left(\frac{1}{\sqrt{2}}, \phi\right) - \sqrt{2}F\left(\frac{1}{\sqrt{2}}, \phi\right)$,

where $\cos x = \cos^2 \phi$.

7. If $a^2 > b^2 > c^2$, shew that

$$\int_{\lambda}^{\infty} \frac{d\lambda}{\sqrt{\lambda} \sqrt{(a^2 + \lambda)(b^2 + \lambda)(c^2 + \lambda)}} = \frac{2}{\sqrt{(a^2 - c^2)}} F(k, \phi),$$

where $k = \sqrt{\frac{a^2 - b^2}{a^2 - c^2}}$ and $\sin \phi = \sqrt{\frac{a^2 - c^2}{a^2 + \lambda}}$.

8. Shew that $\int_1^{\infty} \frac{dx}{\sqrt{(x^3 - 1)}} = \frac{2}{\sqrt[4]{3}} \frac{1}{1+k} F\left(\frac{2\sqrt{k}}{1+k}, \frac{\pi}{2}\right)$,

where $k = \sin 15^\circ$.

[Shew that the integral is equal to

$$\frac{2}{\sqrt[4]{3}(1+k)} \int_0^{\infty} \frac{dy}{\sqrt{\lambda(1+\lambda y^2)(\lambda+y^2)}},$$

where $\lambda = (1-k)/(1+k)$.]

9. Shew that $\int_{-\infty}^1 \frac{dx}{\sqrt{(1-x^3)}} = \frac{2}{\sqrt[4]{3}} \frac{1}{1+k} F\left(\frac{2\sqrt{k}}{1+k}, \frac{\pi}{2}\right)$,

where $k = \cos 15^\circ$.

10. Prove

$$\int_1^{\infty} \frac{dx}{\sqrt{(x^3 - 1)}} = \frac{2}{\sqrt[4]{3}} F\left(\sin 15^\circ, \frac{\pi}{2}\right), \quad \int_{-\infty}^1 \frac{dx}{\sqrt{(1-x^3)}} = \frac{2}{\sqrt[4]{3}} F\left(\cos 15^\circ, \frac{\pi}{2}\right).$$

11. By means of the substitution $x = (4 - y^3)/3y^2$, shew that

$$\int_{-\infty}^1 \frac{dx}{\sqrt{(1-x^3)}} = \sqrt{3} \int_1^{\infty} \frac{dy}{\sqrt{(y^3 - 1)}};$$

deduce that $K' = \sqrt{3}K$, where $k = \sin 15^\circ$.

12. If $A = \int_{-\pi/12}^{\pi/4} \frac{3 \tan^3 \theta + 8 \tan^2 \theta - 2 \tan \theta + 4}{\sqrt{(1 + 2 \sin 2\theta)}} \tan \theta d\theta$

and $B = \int_{-2+\sqrt{3}}^1 \frac{dx}{\sqrt{(x^4 + 4x^3 + 2x^2 + 4x + 1)}}$

prove that $A = B = \frac{1}{2} \int_0^{\pi/2} \frac{d\phi}{\sqrt{(1 - \frac{3}{4} \sin^2 \phi)}} = \frac{2}{3} K\left(\frac{1}{3}\right)$.

13. Prove that the length of the lemniscate $r = a\sqrt{\cos 2\theta}$ is $2\sqrt{2}aF\left(\frac{1}{\sqrt{2}}, \frac{\pi}{2}\right)$.

14. If s denotes the length of an arc of the hyperbola $x^2/a^2 - y^2/b^2 = 1$ measured from the point where it crosses the x -axis, shew that

$$\frac{s}{c} = k'^2 \int_{\xi}^1 \frac{d\xi}{\sqrt{\lambda(1-\xi^2)(1-k^2\xi^2)}} - \int_{\xi}^1 \sqrt{\left(\frac{1-k^2\xi^2}{1-\xi^2}\right)} d\xi + \frac{\sqrt{\lambda(1-\xi^2)(1-k^2\xi^2)}}{\xi},$$

where $\xi = b/\sqrt{(b^2 + y^2)}$, $k = a/c$, and $c = \sqrt{a^2 + b^2}$.

15. Shew that, if $\kappa = k^2$ and $\kappa' = k'^2$,

$$\frac{dK}{d\kappa} = \frac{E - \kappa'K}{2\kappa\kappa'}, \quad \frac{dE}{d\kappa} = \frac{E - K}{2\kappa}.$$

Prove that $(E - \kappa'K)$ satisfies the differential equation

$$4\kappa\kappa' \frac{d^2y}{d\kappa^2} = y.$$

16. Shew that, if $n > 1$,

$$(i) \quad n \int_0^1 k^n K' dk = (n-1) \int_0^1 k^{n-2} E' dk;$$

$$(ii) \quad (n+2) \int_0^1 k^n E' dk = (n+1) \int_0^1 k^n K' dk.$$

17. If P is any point on that branch of the hyperbola $x^2/a^2 - y^2/b^2 = 1$ which crosses the x -axis at A, shew that the difference between the arc AP and the portion of the asymptote cut off by a perpendicular on it from P tends to the limit

$$\frac{b^2}{c} F\left(\frac{a}{c}, \frac{\pi}{2}\right) - cE\left(\frac{a}{c}, \frac{\pi}{2}\right)$$

as P tends to infinity. [Cf. *Example 14.*]

18. Shew that

$$\int_x^2 \frac{dx}{\sqrt{\{(1-x^2)(k'^2+k^2x^2)\}}} = \int_0^y \frac{dy}{\sqrt{\{(1-y^2)(1-k^2y^2)\}}},$$

where $y = \sqrt{1-x^2}$.

19. Shew that

$$\int_x^1 \frac{dx}{\sqrt{\{(1-x^2)(x^2-k'^2)\}}} = \int_0^y \frac{dy}{\sqrt{\{(1-y^2)(1-k^2y^2)\}}},$$

where $ky = \sqrt{1-x^2}$.

20. Prove
$$\int_0^{\pi/6} \frac{d\phi}{\sqrt{(1-4\sin^2\phi)}} = \frac{1}{2} F\left(\frac{1}{2}, \frac{\pi}{2}\right).$$

21. Shew that
$$\int_0^\infty \frac{dx}{\sqrt{\{(1+x^2)(3+2x^2)\}}} = \frac{1}{\sqrt{3}} F\left(\frac{1}{\sqrt{3}}, \frac{\pi}{2}\right).$$

22. Shew that
$$\int_0^1 \frac{dx}{\sqrt{\{x(1-x)(3+x)\}}} = F\left(\frac{1}{2}, \frac{\pi}{2}\right).$$

23. Prove
$$\int_0^1 \frac{15x^2-2x}{\sqrt{\{x(1-x)(5x+4)\}}} dx = \frac{16}{5} F\left(\frac{1}{5}, \frac{\pi}{2}\right).$$

CHAPTER X.

WEIERSTRASSIAN ELLIPTIC FUNCTIONS.

71. Doubly-Periodic Functions. A uniform function $F(z)$ which has two primitive periods Ω and Ω' is said to be *Doubly-Periodic*. For all values of z ,

$$F(z + \Omega) = F(z), \quad F(z + \Omega') = F(z),$$

so that

$$F(z + m\Omega + m'\Omega') = F(z),$$

where m and m' can have any integral values.

THEOREM. The two primitive periods Ω and Ω' cannot have the same amplitude.

For, if they have the same amplitude, let $\Omega = \rho e^{i\theta}$, $\Omega' = \rho' e^{i\theta}$, and assume $\rho > \rho'$. Then, if $\Omega'' = \Omega - \Omega' = (\rho - \rho') e^{i\theta}$, Ω'' is a period of modulus less than ρ . Let this process be repeated with the two periods Ω' and Ω'' ; and so on. After a sufficient number of steps a period is obtained either of modulus zero or of modulus less than any assigned quantity.

The first case cannot occur, however; for if ω denote the value of the two equal periods subtracted in the last step of the process,

$$\omega = \Omega/p = \Omega'/q,$$

where p and q are integers; but this is impossible, since Ω and Ω' are primitive periods.

In the second case, if ω denote the period, the function $\{F(z) - F(z_0)\}$ has zeros at z_0 and $z_0 + \omega$. Accordingly, $F(z)$ has essential singularities at all points of the plane (§ 22, Theorem I. Corollary 1). Such functions are excluded from consideration.

Congruent Points. The points $z + m\Omega + m'\Omega'$, where m and m' may have any integral values, are said to be congruent to the point z .

Period-Parallelograms. A parallelogram of vertices $a, a + \Omega, a + \Omega', a + \Omega + \Omega'$, is called a period-parallelogram. It is sufficient

to study the behaviour of the function in one period-parallelogram in order to know its properties for the entire z -plane. If the whole plane be divided up by two sets of equi-distant parallel lines into a net-work of period-parallelograms, corresponding points of the parallelograms form a set of congruent points. An example of such a net-work was given in § 37.

72. Elliptic Functions. A doubly-periodic function with no singularities in the period-parallelogram except isolated poles is called an *Elliptic Function*. It is convenient to choose the periods $2\omega_1$ and $2\omega_2$ so that, as in § 37, $I(\omega_2/\omega_1)$ is positive.

Weierstrass's Elliptic Function. If we differentiate the series

$$\wp(z) = \frac{1}{z^2} + \sum_{-\infty}^{+\infty} \sum' \left\{ \frac{1}{(z-\Omega)^2} - \frac{1}{\Omega^2} \right\}, \quad (\S 48)$$

we obtain

$$\wp'(z) = \sum_{-\infty}^{+\infty} \sum' \frac{-2}{(z-\Omega)^3} \quad \text{n.B. deal with}$$

From this series the equations

$$\wp'(z+2\omega_1) = \wp'(z), \quad \wp'(z+2\omega_2) = \wp'(z),$$

follow immediately; so that $\wp'(z)$ is an Elliptic Function.

Again, integrating, we have

$$\wp(z+2\omega_1) = \wp(z) + C.$$

Now let $z = -\omega_1$; then

$$\wp(\omega_1) = \wp(-\omega_1) + C = \wp(\omega_1) + C,$$

so that $C = 0$. Thus $\wp(z+2\omega_1) = \wp(z)$.

Similarly $\wp(z+2\omega_2) = \wp(z)$.

Accordingly, $\wp(z)$ is an Elliptic Function.

COROLLARY. If n is any integer, $\{\wp(z)\}^n$ is an elliptic function.

Note. The notation $\wp(z; \omega_1, \omega_2)$ is sometimes used instead of $\wp(z)$.

THEOREM I. The derivatives of an elliptic function are elliptic functions.

For, if $f(z+2\omega_1) = f(z)$, $f(z+2\omega_2) = f(z)$, it follows that

$$f'(z+2\omega_1) = f'(z), \quad f'(z+2\omega_2) = f'(z).$$

THEOREM II. An elliptic function must have at least one pole in a period-parallelogram.

For if not, the function would be finite at every point of the plane, and would therefore, by Liouville's Theorem, be a constant.

Thus the function $\wp(z)$ has poles of the second order at the origin and congruent points; while at all other points it is holomorphic. The principal part at the origin is $1/z^2$. Similarly $\wp'(z)$ has a pole of the third order at the origin, with principal part $-2/z^3$.

COROLLARY. If two elliptic functions have the same periods and the same poles, and if their principal parts at the poles are equal, they can only differ by a constant.

Note. An elliptic function has an essential singularity at infinity: for it has an infinite number of poles in any neighbourhood of infinity (cf. § 48, Note). This holds true for all periodic functions; e.g. $\cot z$.

THEOREM III. An elliptic function can have only a finite number of poles in a period-parallelogram (§ 22, Theorem 2).

THEOREM IV. The sum of the residues of an elliptic function $f(z)$ at points in a period-parallelogram is zero.

Let γ denote the parallelogram ABCD (Fig. 73) of vertices

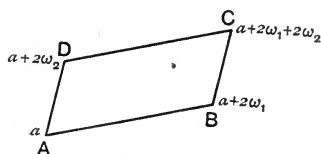

FIG. 73.

$a, a + 2\omega_1, a + 2\omega_1 + 2\omega_2, a + 2\omega_2$, drawn so that none of its sides passes through a singularity of $f(z)$. Then the sum of the residues of $f(z)$ in γ is given by

$$\begin{aligned} \frac{1}{2\pi i} \int_{\gamma} f(z) dz &= \frac{1}{2\pi i} \int_a^{a+2\omega_1} \{f(z) - f(z + 2\omega_2)\} dz \\ &\quad + \frac{1}{2\pi i} \int_a^{a+2\omega_2} \{f(z + 2\omega_1) - f(z)\} dz \\ &= 0. \end{aligned}$$

For example, the residues of $\wp(z)$ and $\wp'(z)$ at $z = 0$ are zero.

COROLLARY. An elliptic function cannot have a single *simple* pole in a period-parallelogram.

Order of an Elliptic Function. The number of poles of an elliptic function in a period-parallelogram, a pole of order s

being counted as s poles, is called the *Order* of the function. It follows from Theorem IV. Corollary, that the order of an elliptic function must be not less than 2.

The two simplest types of elliptic functions are :

(i) functions with a single pole of order 2, at which the principal part is of the form $A/(z-\alpha)^2$, in each period-parallelogram ; $\wp(z)$ is a function of this type :

(ii) functions with two simple poles of principal parts $A/(z-\alpha)$ and $-A/(z-\beta)$ in each period-parallelogram ; it will be shewn in Chapter XI. that the Jacobian functions $\operatorname{sn} u$, $\operatorname{cn} u$, $\operatorname{dn} u$, are of this type.

THEOREM V. The number of zeros of an elliptic function $f(z)$ in a period-parallelogram, where a zero of order r is counted as r zeros, is equal to the order N of $f(z)$.

For (§ 31, Corollary 1)

$$\frac{1}{2\pi i} \int_{\gamma} \frac{f'(z)}{f(z)} dz = \Sigma r - \Sigma s,$$

where γ denotes a period-parallelogram. But, since $f'(z)/f(z)$ is an elliptic function, this integral is zero (Theorem IV.). Hence

$$\Sigma r = \Sigma s = N.$$

Thus, since $\wp'(z)$ has one pole of order 3 in the period-parallelogram, it must have three and only three zeros in the parallelogram. Now, substituting $z = -\omega_1$ in the equation $\wp'(z+2\omega_1) = \wp'(z)$, we obtain $\wp'(\omega_1) = \wp'(-\omega_1)$. But from the series for $\wp'(z)$ it follows that $\wp'(z)$ is odd : hence $\wp'(\omega_1) = 0$. Similarly $\wp'(\omega_2) = 0$, $\wp'(\omega_1 + \omega_2) = 0$. Thus the only non-congruent zeros of $\wp'(z)$ are ω_1 , ω_2 , and $\omega_1 + \omega_2$.

COROLLARY. Since the elliptic function $\{f(z) - C\}$ has the same poles as $f(z)$, the number of its zeros in a period-parallelogram will be N . Hence the number of points in a period-parallelogram at which $f(z) = C$ is N .

THEOREM VI. If the elliptic function $f(z)$ has p zeros a_1, a_2, \dots, a_p , of orders r_1, r_2, \dots, r_p , and q poles b_1, b_2, \dots, b_q , of orders s_1, s_2, \dots, s_q , in a period-parallelogram,

$$\sum_{m=1}^p r_m a_m - \sum_{n=1}^q s_n b_n = 2\lambda\omega_1 + 2\mu\omega_2,$$

where λ and μ are integers.

For, if γ denote a period-parallelogram (§ 31, Corollary 2),

$$\begin{aligned} 2\pi i \left\{ \sum_{m=1}^p r_m a_m - \sum_{n=1}^q s_n b_n \right\} &= \int_{\gamma} z \frac{f'(z)}{f(z)} dz \\ &= \int_a^{a+2\omega_1} \left\{ z \frac{f'(z)}{f(z)} - (z+2\omega_2) \frac{f'(z+2\omega_2)}{f(z+2\omega_2)} \right\} dz \\ &\quad - \int_a^{a+2\omega_2} \left\{ z \frac{f'(z)}{f(z)} - (z+2\omega_1) \frac{f'(z+2\omega_1)}{f(z+2\omega_1)} \right\} dz \\ &= -2\omega_2 \operatorname{Log} \left\{ \frac{f(a+2\omega_1)}{f(a)} \right\} + 2\omega_1 \operatorname{Log} \left\{ \frac{f(a+2\omega_2)}{f(a)} \right\} \\ &= -2\omega_2 \operatorname{Log} 1 + 2\omega_1 \operatorname{Log} 1 \\ &= 2\omega_2 \cdot 2\mu\pi i + 2\omega_1 \cdot 2\lambda\pi i. \end{aligned}$$

Hence
$$\sum_{m=1}^p r_m a_m - \sum_{n=1}^q s_n b_n = 2\lambda\omega_1 + 2\mu\omega_2.$$

Example. Prove that $u = -v - w$ is a simple zero of

$$\wp'(u)\{\wp(v) - \wp(w)\} + \wp'(v)\{\wp(w) - \wp(u)\} + \wp'(w)\{\wp(u) - \wp(v)\}.$$

This is an elliptic function in u of order 3, its only pole being at $u=0$. Two zeros are $u=v$ and $u=w$, so that the third must be congruent to $-v-w$ (Theorem VI.). Also (Theorem V.) each zero must be of the first order.

73. Relation between $\wp(z)$ and $\wp'(z)$. We shall now prove that $\wp(z)$ satisfies the differential equation

$$\wp'^2(z) = 4\wp^3(z) - g_2\wp(z) - g_3,$$

where g_2 and g_3 are constants.

Near $z=0$ we have

$$\left(\frac{1}{(z-\Omega)^2} - \frac{1}{\Omega^2} \right) = \frac{2z}{\Omega^3} + \frac{3z^2}{\Omega^4} + \frac{4z^3}{\Omega^5} + \dots$$

Accordingly

$$\wp(z) = \frac{1}{z^2} + \sum_{-\infty}^{+\infty} \sum' \left\{ \frac{2z}{\Omega^3} + \frac{3z^2}{\Omega^4} + \frac{4z^3}{\Omega^5} + \dots \right\}.$$

But if n is odd, $\sum_{-\infty}^{+\infty} \sum' \frac{1}{\Omega^n} = 0$; therefore

$$\wp(z) = \frac{1}{z^2} + \frac{g_2}{20} z^2 + \frac{g_3}{28} z^4 + Az^6 + \dots,$$

where

$$g_2 = 60 \sum_{-\infty}^{+\infty} \sum' \frac{1}{\Omega^4} = 4 \cdot 3 \cdot 5 \sum_{-\infty}^{+\infty} \sum' \frac{1}{\Omega^4},$$

$$g_3 = 140 \sum_{-\infty}^{+\infty} \sum' \frac{1}{\Omega^6} = 4 \cdot 5 \cdot 7 \sum_{-\infty}^{+\infty} \sum' \frac{1}{\Omega^6}.$$

From this equation we derive the following equations :

$$\begin{aligned} \wp'(z) &= -\frac{2}{z^3} + \frac{g_2 z}{10} + \frac{g_3 z^3}{7} + 6Az^5 + \dots; \\ \wp'^2(z) &= \frac{4}{z^6} - \frac{2g_2}{5z^2} - \frac{4g_3}{7} + Bz^2 + \dots; \\ \wp^3(z) &= \frac{1}{z^6} + \frac{13g_2}{20z^2} + \frac{13g_3}{28} + Cz^2 + \dots \end{aligned}$$

Hence, if $\phi(z)$ denotes the function

$$\wp'^2(z) - 4\wp^3(z) + g_2\wp(z) + g_3,$$

near $z=0$,

$$\phi(z) = Dz^2 + Ez^4 + \dots$$

Thus the elliptic function $\phi(z)$ has no pole at the origin. But the origin is its only possible pole. It is therefore a constant (Theorem II. § 72); and since $\phi(0)=0$, the constant is zero. Thus

$$\wp'^2(z) = 4\wp^3(z) - g_2\wp(z) - g_3. \tag{A}$$

The quantities g_2 and g_3 are called the invariants of $\wp(z)$. It is sometimes found useful to use the notation $\wp(z; g_2, g_3)$ for $\wp(z)$.

COROLLARY. By differentiating equation (A) we obtain :

$$\begin{aligned} \wp''(z) &= 6\wp^2(z) - \frac{1}{2}g_2; \\ \wp'''(z) &= 12\wp(z)\wp'(z); \\ \wp^{iv}(z) &= 12\wp(z)\wp''(z) + 12\wp'^2(z) \\ &= 72\wp^3(z) - 6g_2\wp(z) + 12\wp'^2(z); \\ &\dots\dots\dots \end{aligned}$$

Thus every derivative of $\wp(z)$ can be expressed as a polynomial in $\wp(z)$ and $\wp'(z)$.

Example. Prove that the function $\{\wp(u)\wp'(u) + \wp^2(u) - 1\}$ has five zeros, u_1, u_2, u_3, u_4, u_5 , in a period-parallellogram, such that $\sum_{r=1}^{r=5} u_r = 2\lambda\omega_1 + 2\mu\omega_2$, where λ and μ are integers. Verify that, if $z = \wp(u)$, these values of u give the five roots of the equation

$$4z^5 - z^4 - g_2z^3 + (2 - g_3)z^2 - 1 = 0.$$

If $\wp'(z)=0$, equation (A) becomes

$$4\wp^3(z) - g_2\wp(z) - g_3 = 0.$$

Now we know (Theorem V. § 72) that $\wp'(\omega_1), \wp'(\omega_2), \wp'(\omega_1 + \omega_2)$, are all zero. Hence the three roots of this cubic in $\wp(z)$ are e_1, e_2, e_3 , where $e_1 = \wp(\omega_1), e_2 = \wp(\omega_1 + \omega_2), e_3 = \wp(\omega_2)$.

It follows that equation (A) can be written

$$\wp'^2(z) = 4\{\wp(z) - e_1\}\{\wp(z) - e_2\}\{\wp(z) - e_3\}. \tag{B}$$

If the coefficients in equations (A) and (B) are equated, the following important relations are obtained:

$$e_1 + e_2 + e_3 = 0,$$

$$e_1e_2 + e_2e_3 + e_3e_1 = -\frac{1}{4}g_2, \quad e_1e_2e_3 = \frac{1}{4}g_3.$$

The Weierstrassian Elliptic Integral. Let $z = \wp(w)$: then, since

$$\wp'^2(w) = 4\wp^3(w) - g_2\wp(w) - g_3,$$

$$\frac{dz}{dw} = \sqrt{(4z^3 - g_2z - g_3)}.$$

Now when $w = 0$, $z = \infty$; therefore

$$w = \int_{\infty}^z \frac{dz}{\sqrt{(4z^3 - g_2z - g_3)}}.$$

The two branches of the integrand give equal and opposite values of w , which correspond to the same value of z , since $\wp(w)$ is even.

74. The Addition Theorem. Consider the elliptic function

$$f(u) = \wp(u+v) + \wp(u) + \wp(v) - \frac{1}{4} \left\{ \frac{\wp'(u) - \wp'(v)}{\wp(u) - \wp(v)} \right\}^2 + \rho.$$

The functions $\wp(u+v)$, $\wp(u)$, and $\wp'(u)$ have poles at $u = -v$, $u = 0$, and $u = 0$ respectively; while $\{\wp(u) - \wp(v)\}$ has zeros at $u = \pm v$. Hence the only possible non-congruent infinities of $f(u)$ are $u = 0$, $u = \pm v$.

Near $u = 0$,

$$\begin{aligned} f(u) &= \wp(v) + u\wp'(v) + \dots + \frac{1}{u^2} + Au^2 + \dots + \wp(v) \\ &\quad - \frac{1}{4} \left\{ \frac{-\frac{2}{u^3} - \wp'(v) + 2Au + \dots}{\frac{1}{u^2} - \wp(v) + Au^2 + \dots} \right\}^2 \\ &= \frac{1}{u^2} + 2\wp'(v) + u\wp'(v) + \dots - \frac{1}{u^2} \{1 + 2u^2\wp(v) + u^3\wp'(v) + \dots\} \\ &= Bu^2 + \dots \end{aligned}$$

Accordingly, when $u = 0$, $f(u)$ is finite and has the value zero.

Again, let $u = v + \epsilon$; then

$$\begin{aligned} f(u) &= \wp(2v) + \epsilon\wp'(2v) + \dots + \wp(v) + \epsilon\wp'(v) + \dots + \wp(v) \\ &\quad - \frac{1}{4} \left\{ \frac{\wp'(v) + \epsilon\wp''(v) + \frac{\epsilon^2}{2}\wp'''(v) + \dots - \wp'(v)}{\wp(v) + \epsilon\wp'(v) + \frac{\epsilon^2}{2}\wp''(v) + \dots - \wp(v)} \right\}^2 \\ &= \wp(2v) + 2\wp(v) + \epsilon\{\wp'(2v) + \wp'(v)\} + \dots \\ &\quad - \frac{1}{4} \left\{ \frac{\wp''(v) + \frac{\epsilon}{2}\wp'''(v) + \dots}{\wp'(v) + \frac{\epsilon}{2}\wp''(v) + \dots} \right\}^2. \end{aligned}$$

Hence $f(u)$ is finite when $u = v$.

Finally, let $u = -v + \epsilon$; then

$$\begin{aligned} f(u) &= \frac{1}{\epsilon^2} + A\epsilon^2 + \dots + \wp(v) - \epsilon\wp'(v) + \dots + \wp(v) \\ &\quad - \frac{1}{4} \left\{ \frac{-\wp'(v) + \epsilon\wp''(v) - \frac{\epsilon^2}{2}\wp'''(v) + \dots - \wp'(v)}{\wp(v) - \epsilon\wp'(v) + \frac{\epsilon^2}{2}\wp''(v) - \frac{\epsilon^3}{6}\wp'''(v) + \dots - \wp(v)} \right\}^2 \\ &= \frac{1}{\epsilon^2} + 2\wp(v) - \epsilon\wp'(v) + \dots - \frac{1}{\epsilon^2} \left\{ 1 + \frac{\epsilon^2}{6} \frac{\wp'''(v)}{\wp'(v)} + \dots \right\}. \end{aligned}$$

Hence $f(u)$ is finite at $u = -v$.

Thus $f(u)$ is constant (Theorem II. § 72). But when $u = 0$, $f(u)$ has the value zero; therefore

$$\wp(u + v) = -\wp(u) - \wp(v) + \frac{1}{4} \left\{ \frac{\wp'(u) - \wp'(v)}{\wp(u) - \wp(v)} \right\}^2.$$

This is the *Addition Theorem* for the Weierstrassian Elliptic Function.

COROLLARY. $\wp(u - v) = -\wp(u) - \wp(v) + \frac{1}{4} \left\{ \frac{\wp'(u) + \wp'(v)}{\wp(u) - \wp(v)} \right\}^2.$

Example. Prove $\wp(u + v) = \wp(u) - \frac{1}{2} \frac{\partial}{\partial u} \left\{ \frac{\wp'(u) - \wp'(v)}{\wp(u) - \wp(v)} \right\}.$

Duplication Formula. If $u = v + \epsilon$, the addition theorem gives

$$\begin{aligned} \wp(2v + \epsilon) &= -\wp(v + \epsilon) - \wp(v) + \frac{1}{4} \left\{ \frac{\wp'(v) + \epsilon\wp''(v) + \frac{\epsilon^2}{2}\wp'''(v) + \dots - \wp'(v)}{\wp(v) + \epsilon\wp'(v) + \frac{\epsilon^2}{2}\wp''(v) + \dots - \wp(v)} \right\}^2 \\ &= -\wp(v + \epsilon) - \wp(v) + \frac{1}{4} \left\{ \frac{\wp''(v) + \frac{\epsilon}{2}\wp'''(v) + \dots}{\wp'(v) + \frac{\epsilon}{2}\wp''(v) + \dots} \right\}^2. \end{aligned}$$

Therefore, if $\epsilon = 0$,

$$\wp(2v) = -2\wp(v) + \frac{1}{4} \left\{ \frac{\wp''(v)}{\wp'(v)} \right\}^2.$$

Example. Shew that

$$\wp(2u) = \wp(u) - \frac{1}{4} \frac{d^2}{du^2} \{ \log \wp'(u) \}.$$

The following three formulae can be deduced from the addition theorem:

$$\begin{aligned} \wp(u + \omega_1) - e_1 &= \frac{(e_1 - e_2)(e_1 - e_3)}{\wp(u) - e_1}; \\ \wp(u + \omega_1 + \omega_2) - e_2 &= \frac{(e_2 - e_3)(e_2 - e_1)}{\wp(u) - e_2}; \\ \wp(u + \omega_2) - e_3 &= \frac{(e_3 - e_1)(e_3 - e_2)}{\wp(u) - e_3}. \end{aligned}$$

The proof is left as an exercise to the reader.

Example. Prove

$$\wp'(u)\wp'(u + \omega_1)\wp'(u + \omega_1 + \omega_2)\wp'(u + \omega_2) = 16(e_1 - e_2)^2(e_2 - e_3)^2(e_3 - e_1)^2.$$

75. Properties of the Zeta Function. Integrating the equation

$$\wp(u + 2\omega_1) = \wp(u),$$

we have

$$\zeta(u + 2\omega_1) = \zeta(u) + 2\eta_1,$$

where $2\eta_1$ is a constant.

Now, let $u = -\omega_1$; then $\zeta(\omega_1) = \zeta(-\omega_1) + 2\eta_1$;

so that

$$\eta_1 = \zeta(\omega_1).$$

Similarly

$$\zeta(u + 2\omega_2) = \zeta(u) + 2\eta_2,$$

where

$$\eta_2 = \zeta(\omega_2).$$

It follows that

$$\zeta(u + 2m\omega_1 + 2n\omega_2) = \zeta(u) + 2m\eta_1 + 2n\eta_2,$$

and that

$$\zeta(m\omega_1 + n\omega_2) = m\eta_1 + n\eta_2.$$

The Zeta function is not an elliptic function. It possesses, however, a sort of periodicity, and is called a *Periodic Function of the Second Kind*. In each period-parallelogram it has a simple pole congruent to $u = 0$. The residue at this pole is unity; for, if we integrate

$$\wp(u) = \frac{1}{u^2} + \frac{g_2}{20}u^2 + \dots,$$

we obtain

$$\zeta(u) = C + \frac{1}{u} - \frac{g_2}{60}u^3 + \dots$$

But, since $\zeta(u)$ is odd, $C=0$; therefore

$$\zeta(u) = \frac{1}{u} - \frac{g_2}{60}u^3 + \dots \quad (\text{Cf. § 48.})$$

Example. Shew that $\zeta(2u) = 2\zeta(u) + \frac{1}{2} \frac{\wp''(u)}{\wp'(u)}$.

Again, let $\zeta(u)$ be integrated round the period-parallelogram γ (Fig. 73); then

$$\begin{aligned} \int_{\gamma} \zeta(u) du &= \int_a^{a+2\omega_1} \{\zeta(u) - \zeta(u+2\omega_2)\} du - \int_a^{a+2\omega_2} \{\zeta(u) - \zeta(u+2\omega_1)\} du \\ &= -4\eta_2\omega_1 + 4\eta_1\omega_2 \\ &= 2\pi i, \end{aligned}$$

since there is only one pole in γ . Thus

$$\eta_1\omega_2 - \eta_2\omega_1 = i\frac{\pi}{2}.$$

This is *Legendre's Relation* for the Weierstrassian Elliptic Functions.

THEOREM. Any elliptic function can be expressed linearly in terms of zeta functions and the derivatives of zeta functions.

Let $f(u)$ be an elliptic function of periods $2\omega_1$ and $2\omega_2$, and let a, b, c, \dots, k be its poles in a period-parallelogram. Also let the principal parts of $f(u)$ at these poles be

$$\begin{aligned} &\frac{A_1}{u-a} + \frac{A_2}{(u-a)^2} + \dots + \frac{A_{n_1}}{(u-a)^{n_1}}, \\ &\frac{B_1}{u-b} + \frac{B_2}{(u-b)^2} + \dots + \frac{B_{n_2}}{(u-b)^{n_2}}, \\ &\dots\dots\dots \\ &\frac{K_1}{u-k} + \frac{K_2}{(u-k)^2} + \dots + \frac{K_{n_k}}{(u-k)^{n_k}}. \end{aligned}$$

Then consider the function

$$\begin{aligned} \phi(u) &= -f(u) + \left\{ A_1\zeta(u-a) - \frac{A_2}{1!}\zeta'(u-a) + \dots \right. \\ &\quad \left. + (-1)^{n_1-1} \frac{A_{n_1}}{(n_1-1)!} \frac{d^{n_1-1}}{du^{n_1-1}} \zeta(u-a) \right\} \\ &\quad + \{B_1\zeta(u-b) + \dots\} + \dots + \{K_1\zeta(u-k) + \dots\}. \end{aligned}$$

This function is finite at all points of the period-parallelogram.

Also

$$\begin{aligned} \phi(u + 2\omega_1) &= \phi(u) + 2\eta_1(A_1 + B_1 + \dots + K_1) \\ &= \phi(u). \end{aligned} \quad (\text{Theorem IV. § 72.})$$

Similarly $\phi(u + 2\omega_2) = \phi(u)$.

Accordingly, $\phi(u)$ is a constant (Theorem II. § 72); therefore

$$\begin{aligned} f(u) &= C + \Sigma \left\{ A_1 \zeta(u-a) - \frac{A_2}{1!} \zeta'(u-a) + \dots \right. \\ &\quad \left. + (-1)^{n_1-1} \frac{A_{n_1}}{(n_1-1)!} \frac{d^{n_1-1}}{du^{n_1-1}} \zeta(u-a) \right\}. \end{aligned} \quad (A)$$

Example. Shew that

$$2\zeta(2u) + 2\eta_1 + 2\eta_2 = \zeta(u) + \zeta(u + \omega_1) + \zeta(u + \omega_1 + \omega_2) + \zeta(u + \omega_2).$$

76. Properties of the Sigma Function. Integrating

$$\zeta(u + 2\omega_1) = \zeta(u) + 2\eta_1,$$

we have

$$\log \{ \sigma(u + 2\omega_1) \} = \log \{ \sigma(u) \} + 2\eta_1 u + C; \quad (\text{cf. § 50})$$

or

$$\sigma(u + 2\omega_1) = C' \sigma(u) e^{2\eta_1 u}.$$

Now let $u = -\omega_1$; then $\sigma(\omega_1) = C' \sigma(-\omega_1) e^{-2\eta_1 \omega_1}$,

so that

$$C' = -e^{2\eta_1 \omega_1}.$$

Therefore

$$\sigma(u + 2\omega_1) = -e^{2\eta_1(u + \omega_1)} \sigma(u).$$

Similarly

$$\sigma(u + 2\omega_2) = -e^{2\eta_2(u + \omega_2)} \sigma(u).$$

By the method of induction it can be deduced that

$$\sigma(u + 2m\omega_1 + 2n\omega_2) = (-1)^{mn+m+n} e^{2(m\eta_1+n\eta_2)(u+m\omega_1+n\omega_2)} \sigma(u).$$

The Sigma function is called a *Periodic Function of the Third Kind*.

Near $u = 0$ we have

$$\zeta(u) = \frac{1}{u} - \frac{g_2}{60} u^3 + \dots$$

Hence

$$\log \{ \sigma(u) \} = \log u + C - \frac{g_2}{240} u^4 + \dots$$

But $\lim_{u \rightarrow 0} \left\{ \frac{\sigma(u)}{u} \right\} = 1$, so that $C = 0$; therefore

$$\log \{ \sigma(u) \} = \log u - \frac{g_2}{240} u^4 + \dots$$

Thus

$$\begin{aligned} \sigma(u) &= u e^{-\frac{g_2}{240} u^4 + \dots} \\ &= u - \frac{g_2}{240} u^5 + \dots \end{aligned}$$

THEOREM. Any elliptic function can be expressed in terms of sigma functions.

Let $f(u)$ denote an elliptic function of periods $2\omega_1, 2\omega_2$, having in a particular period-parallelogram zeros a_1, a_2, \dots, a_p , of orders m_1, m_2, \dots, m_p , and poles b_1, b_2, \dots, b_q , of orders n_1, n_2, \dots, n_q . Then consider the function

$$\phi(u) = f(u) \frac{\{\sigma(u-b_1)\}^{n_1} \{\sigma(u-b_2)\}^{n_2} \dots \{\sigma(u-b_q)\}^{n_q}}{\{\sigma(u-a_1)\}^{m_1} \{\sigma(u-a_2)\}^{m_2} \dots \{\sigma(u-a_p)\}^{m_p}}.$$

We choose the a 's and b 's so that $\sum m a - \sum n b = 0$, replacing, if necessary, some of them by congruent points (Theorem VI. §72).

Now $\phi(u)$ is finite at all points of the period-parallelogram. But

$$\begin{aligned} \phi(u+2\omega_1) &= \phi(u) (-1)^{\sum n - \sum m} e^{2n_1 \{\sum n(u-b+\omega_1) - \sum m(u-a+\omega_1)\}} \\ &= \phi(u), \end{aligned} \quad (\text{Theorem V. §72.})$$

Similarly $\phi(u+2\omega_2) = \phi(u)$.

Thus (Theorem II., §72), $\phi(u)$ is a constant; so that

$$f(u) = C \frac{\{\sigma(u-a_1)\}^{m_1} \{\sigma(u-a_2)\}^{m_2} \dots \{\sigma(u-a_p)\}^{m_p}}{\{\sigma(u-b_1)\}^{n_1} \{\sigma(u-b_2)\}^{n_2} \dots \{\sigma(u-b_q)\}^{n_q}}.$$

For example, the function $\{\wp(u) - \wp(v)\}$ has two simple zeros $\pm v$, and a pole of order 2 at $u=0$; therefore

$$\wp(u) - \wp(v) = C \frac{\sigma(u+v)\sigma(u-v)}{\sigma^2(u)}.$$

In this equation let u be small; then

$$\frac{1}{u^2} - \wp(v) + Au^2 + \dots = C \frac{1}{u^2} [-\sigma^2(v) + Bu^2 + \dots].$$

Hence, equating the coefficients of $\frac{1}{u^2}$, we have

$$1 = -C\sigma^2(v);$$

so that
$$\wp(u) - \wp(v) = -\frac{\sigma(u+v)\sigma(u-v)}{\sigma^2(u)\sigma^2(v)}. \quad (\text{A})$$

COROLLARY. If in equation (A) we put $v = u + \epsilon$, and make ϵ tend to zero, we obtain

$$\wp'(u) = -\frac{\sigma(2u)}{\sigma^4(u)}.$$

Example 1. Shew that

$$\wp(u) = -2 \frac{\sigma(u-\omega_1)\sigma(u-\omega_2)\sigma(u+\omega_1+\omega_2)}{\sigma(\omega_1)\sigma(\omega_2)\sigma(\omega_1+\omega_2)\sigma^3(u)}.$$

Again, if equation (A) be differentiated logarithmically,

$$\frac{\wp'(u)}{\wp(u) - \wp(v)} = \zeta(u+v) + \zeta(u-v) - 2\zeta(u).$$

In this equation interchange u and v ; then

$$-\frac{\wp'(v)}{\wp(u) - \wp(v)} = \zeta(u+v) - \zeta(u-v) - 2\zeta(v).$$

Hence
$$\frac{1}{2} \frac{\wp'(u) - \wp'(v)}{\wp(u) - \wp(v)} = \zeta(u+v) - \zeta(u) - \zeta(v). \tag{B}$$

COROLLARY. If in formula (A) of § 75 we make the substitution

$$\zeta(u-a) = \zeta(u) - \zeta(a) + \frac{1}{2} \frac{\wp'(u) + \wp'(a)}{\wp(u) - \wp(a)},$$

and similar substitutions for $\zeta(u-b)$, ..., $\zeta(u-k)$; then, since $\Sigma A_1 = 0$, it follows that $f(u)$ can be expressed as a rational function of $\wp(u)$ and $\wp'(u)$.

Example 2. From equation (B) deduce the addition theorem

$$\wp(u+v) = -\wp(u) - \wp(v) + \frac{1}{4} \left\{ \frac{\wp'(u) - \wp'(v)}{\wp(u) - \wp(v)} \right\}^2.$$

EXAMPLES X.

1. Find the zeros of

$$\wp^2(u)\{\wp(v) - \wp(w)\} + \wp^2(v)\{\wp(w) - \wp(u)\} + \wp^2(w)\{\wp(u) - \wp(v)\},$$

and shew that they are all simple zeros.

Ans. $\pm v, \pm w.$

2. Find the poles and zeros of

$$\frac{\wp'(u) - \wp'(v)}{\wp(u) - \wp(v)} - \frac{\wp'(u) - \wp'(w)}{\wp(u) - \wp(w)}.$$

Ans. Simple poles, $-v, -w$; simple zeros, $0, -v-w.$

3. If $\wp(z)$ is constructed with $2\omega_1, 2\omega_2$, as primitive periods, while $\wp_1(z)$ is similarly constructed with $2\omega_1/n, 2\omega_2$, as primitive periods, prove that

$$\begin{aligned} \wp_1(z) = \wp(z) + \left\{ \wp\left(z + \frac{2\omega_1}{n}\right) - \wp\left(\frac{2\omega_1}{n}\right) \right\} + \dots \\ + \left[\wp\left\{z + (n-1)\frac{2\omega_1}{n}\right\} - \wp\left\{(n-1)\frac{2\omega_1}{n}\right\} \right]. \end{aligned}$$

4. Shew that

(i) $4\wp(2z) = \wp(z) + \wp(z + \omega_1) + \wp(z + \omega_1 + \omega_2) + \wp(z + \omega_2)$;

(ii) $\wp(\frac{1}{2}\omega_1) + \wp(\frac{1}{2}\omega_1 + \omega_2) = 2e_1.$

5. Shew that

(i) $\wp(u+v) + \wp(u-v) = 2\wp(v) - \frac{\partial^2}{\partial v^2} \log \{\wp(u) - \wp(v)\}$;

(ii) $\wp(u+v) - \wp(u-v) = -\frac{\partial^2}{\partial u \partial v} \log \{\wp(u) - \wp(v)\}.$

6. Prove
$$\frac{\wp'(u) - \wp'(v)}{\wp(u) - \wp(v)} = -\frac{\wp'(u+v) + \wp'(v)}{\wp(u+v) - \wp(v)}.$$

7. Shew that

$$\begin{vmatrix} \wp'''(u-v), & \wp'''(v-w), & \wp'''(w-u) \\ \wp''(u-v), & \wp''(v-w), & \wp''(w-u) \\ \wp(u-v), & \wp(v-w), & \wp(w-u) \end{vmatrix} = \frac{1}{2}g_2 \begin{vmatrix} \wp'''(u-v), & \wp'''(v-w), & \wp'''(w-u) \\ \wp(u-v), & \wp(v-w), & \wp(w-u) \\ 1, & 1, & 1 \end{vmatrix}.$$

8. Prove
$$\wp(2v) - \wp(2w) = -\frac{\wp'(v+w)\wp'(v-w)}{\{\wp(v+w) - \wp(v-w)\}^2}.$$

9. Shew that

(i)
$$\wp(2u) - \wp(2v) = \frac{\{\wp(u) - \wp(v)\} \{\wp(u) - \wp(v + \omega_1)\} \times \{\wp(u) - \wp(v + \omega_1 + \omega_2)\} \{\wp(u) - \wp(v + \omega_2)\}}{\wp'^2(u)};$$

(ii)
$$\wp(2u) - \wp(\omega_1) = \frac{\left\{ \wp(u) - \wp\left(\frac{\omega_1}{2}\right) \right\}^2 \left\{ \wp(u) - \wp\left(\frac{\omega_1 + \omega_2}{2}\right) \right\}^2}{\wp'^2(u)}.$$

10. Prove
$$\frac{\wp''(u)}{\wp'(u)} + \frac{\wp''(u + \omega_1)}{\wp'(u + \omega_1)} + \frac{\wp''(u + \omega_1 + \omega_2)}{\wp'(u + \omega_1 + \omega_2)} + \frac{\wp''(u + \omega_2)}{\wp'(u + \omega_2)} = 0.$$

11. Prove
$$\frac{\wp'(u + \omega_1)}{\wp'(u)} = -\frac{\wp\left(\frac{1}{2}\omega_1\right) - \wp(\omega_1)}{\wp(u) - \wp(\omega_1)}.$$

12. Shew that

$$\begin{aligned} & \{\wp(u) + \wp(u + \omega_1 + \omega_2)\} \{\wp(u + \omega_1) + \wp(u + \omega_2)\} \\ & \quad = -4\wp(\omega_1 + \omega_2)\wp(2u) - 4\wp(\omega_1)\wp(\omega_2). \end{aligned}$$

13. If $\phi(u) = \wp^2(u)\{\wp(v) - \wp(w)\} + \wp^2(v)\{\wp(w) - \wp(u)\} + \wp^2(w)\{\wp(u) - \wp(v)\}$
and $\psi(u) = \wp'(u)\{\wp(v) - \wp(w)\} + \wp'(v)\{\wp(w) - \wp(u)\} + \wp'(w)\{\wp(u) - \wp(v)\}$,

shew that

$$\wp(u) - \wp(u + v + w) = 2 \frac{\partial}{\partial u} \frac{\phi(u)}{\psi(u)}.$$

14. Shew that

$$\begin{aligned} \wp(u-v)\wp(u-w) &= \wp(v-w)\{\wp(u-v) + \wp(u-w) - \wp(v) - \wp(w)\} \\ & \quad + \wp'(v-w)\{\zeta(u-v) - \zeta(u-w) + \zeta(v) - \zeta(w)\} + \wp(v)\wp(w). \end{aligned}$$

15. Prove $\{\wp(u + \omega_1) - e_1\}\wp'(u) = \wp''(\omega_1)\{\zeta(u + \omega_1) - \zeta(u) - \eta_1\}.$

16. Prove

$$\begin{aligned} \sigma(a+b)\sigma(a-b)\sigma(c+d)\sigma(c-d) - \sigma(a+c)\sigma(a-c)\sigma(b+d)\sigma(b-d) \\ + \sigma(a+d)\sigma(a-d)\sigma(b+c)\sigma(b-c) = 0. \end{aligned}$$

17. Shew that
$$\frac{\sigma(3u)}{\sigma^3(u)} = 3\wp(u)\{\wp'(u)\}^2 - \frac{1}{4}\{\wp''(u)\}^2.$$

18. Shew that
$$\sigma(2u) = 2 \frac{\sigma(u)\sigma(u - \omega_1)\sigma(u - \omega_2)\sigma(u + \omega_1 + \omega_2)}{\sigma(\omega_1)\sigma(\omega_2)\sigma(\omega_1 + \omega_2)}.$$

19. Prove

$$\begin{vmatrix} 1 & \wp(u) & \wp'(u) \\ 1 & \wp(v) & \wp'(v) \\ 1 & \wp(w) & \wp'(w) \end{vmatrix} = 2 \frac{\sigma(u-v)\sigma(v-w)\sigma(w-u)\sigma(u+v+w)}{\sigma^3(u)\sigma^3(v)\sigma^3(w)}.$$

20. Prove

$$\begin{vmatrix} 1 & \wp(x) & \wp^2(x) & \wp'(x) \\ 1 & \wp(y) & \wp^2(y) & \wp'(y) \\ 1 & \wp(z) & \wp^2(z) & \wp'(z) \\ 1 & \wp(w) & \wp^2(w) & \wp'(w) \end{vmatrix} = 2 \frac{\sigma(x-y)\sigma(x-z)\sigma(x-w)\sigma(y-z)\sigma(y-w) \times \sigma(z-w)\sigma(x+y+z+w)}{\sigma^4(x)\sigma^4(y)\sigma^4(z)\sigma^4(w)}.$$

21. Prove

$$\frac{\wp'(u) - \wp'(v)}{\wp(u) - \wp(v)} - \frac{\wp'(u) - \wp'(w)}{\wp(u) - \wp(w)} = \frac{2\sigma(u)\sigma(u+v+w)\sigma(v-w)}{\sigma(u+v)\sigma(u+w)\sigma(v)\sigma(w)}.$$

22. Shew that

$$\wp(u) - \wp(u + \omega_1) = \frac{\sigma^2(\omega_1)\sigma\left(u + \frac{\omega_1}{2}\right)\sigma\left(u - \frac{\omega_1}{2}\right)\sigma\left(u + \frac{\omega_1}{2} + \omega_2\right)\sigma\left(u - \frac{\omega_1}{2} - \omega_2\right)}{\sigma^2(u)\sigma^2(u + \omega_1)\sigma^2\left(\frac{\omega_1}{2}\right)\sigma^2\left(\frac{\omega_1}{2} + \omega_2\right)}.$$

23. Shew that

$$2\wp'(2u)\wp'(u) = \{\wp(u) - \wp(u + \omega_1)\}\{\wp(u) - \wp(u + \omega_1 + \omega_2)\}\{\wp(u) - \wp(u + \omega_2)\}.$$

24. If $u + v + w = 0$, prove

$$\{\zeta(u) + \zeta(v) + \zeta(w)\}^2 = \wp(u) + \wp(v) + \wp(w).$$

25. Shew that

$$2\zeta(2u) = \zeta(u) + \zeta(u - \omega_1) + \zeta(u + \omega_1 + \omega_2) + \zeta(u - \omega_2).$$

26. Shew that

$$2 \begin{vmatrix} 1 & \wp(u) & \wp^2(u) \\ 1 & \wp(v) & \wp^2(v) \\ 1 & \wp(w) & \wp^2(w) \end{vmatrix} \div \begin{vmatrix} 1 & \wp(u) & \wp'(u) \\ 1 & \wp(v) & \wp'(v) \\ 1 & \wp(w) & \wp'(w) \end{vmatrix} = \zeta(u+v+w) - \zeta(u) - \zeta(v) - \zeta(w).$$

27. Prove

$$\zeta(u-v) - \zeta(u-w) - \zeta(v-w) + \zeta(2v-2w) = \frac{\sigma(u-2v+w)\sigma(u+v-2w)}{\sigma(2w-2v)\sigma(u-v)\sigma(u-w)}.$$

CHAPTER XI.

JACOBIAN ELLIPTIC FUNCTIONS.

77. The Values of $\wp(w)$ when ω_1 is Real and ω_2 is Purely Imaginary. Let $\omega_1 = \Omega_1$, $\omega_2 = i\Omega_2$, where Ω_1 and Ω_2 are real and positive; then

$$g_2 = 4 \cdot 3 \cdot 5 \sum_{n=0}^{\infty} \sum_{m=-\infty}^{\infty} \left\{ \frac{1}{(2m\Omega_1 + 2ni\Omega_2)^4} + \frac{1}{(2m\Omega_1 - 2ni\Omega_2)^4} \right\}.$$

The two terms in this bracket are conjugate complex numbers, so that g_2 is real. Similarly it can be shewn that g_3 is real, and that, if w is real, $\wp(w)$ and $\wp'(w)$ are real; while if w is purely imaginary, $\wp(w)$ is real and $\wp'(w)$ is purely imaginary.

Thus $e_1 = \wp(\Omega_1)$ and $e_3 = \wp(i\Omega_2)$ are real; also, since $e_2 = -e_1 - e_3$, $e_2 = \wp(\Omega_1 + i\Omega_2)$ is real. Hence the three roots of the equation $4x^3 - g_2x - g_3 = 0$ are all real.

Now consider the values of $\wp(w)$ at points on the rectangle OABC (Fig. 74), where A, B, C are the points Ω_1 , $\Omega_1 + i\Omega_2$, $i\Omega_2$, respectively.

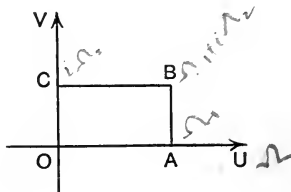

FIG. 74.

(i) If $w = u$ is real, small, and positive, $\wp'(u)$ is, large and negative; also, when $u = \Omega_1$, $\wp'(u)$ vanishes. Between these points on the real axis $\wp'(u)$ is continuous, and has no zero values (§72, Th. V.). Accordingly, between 0 and Ω_1 , $\wp'(u)$ is negative; so that $\wp(u)$ decreases continuously from $+\infty$ to e_1 .

Now $\wp'^2(u) = 4\{\wp(u) - e_1\}\{\wp(u) - e_2\}\{\wp(u) - e_3\}$.

Therefore since, as u increases from 0 to Ω_1 , $\wp'^2(u)$ decreases continuously from $+\infty$ to 0 and $\wp(u)$ decreases continuously from $+\infty$ to e_1 , e_1 is the greatest root of $4x^3 - g_2x - g_3 = 0$.

Again, $\wp'(u) = \pm \sqrt{4\wp^3(u) - g_2\wp(u) - g_3}$; but between 0 and Ω_1 , $\wp'(u)$ is negative and $4\{\wp(u) - e_1\}\{\wp(u) - e_2\}\{\wp(u) - e_3\}$ is positive. Therefore

$$\wp'(u) = -\sqrt{4\wp^3(u) - g_2\wp(u) - g_3}.$$

Hence, if $x = \wp(u)$,

$$u = \int_x^\infty \frac{dx}{\sqrt{4x^3 - g_2x - g_3}},$$

provided $x \geq e_1$. In particular,

$$\Omega_1 = \int_{e_1}^\infty \frac{dx}{\sqrt{4x^3 - g_2x - g_3}}.$$

(ii) Let $w = iv$, where v is real; then

$$\begin{aligned} -\wp(iv) &= \frac{1}{v^2} + \Sigma \Sigma' \left\{ \frac{1}{(v - 2n\Omega_2 + 2mi\Omega_1)^2} - \frac{1}{(2n\Omega_2 - 2mi\Omega_1)^2} \right\} \\ &= \wp(v; \Omega_2, i\Omega_1) = \wp(v; g_2, -g_3) \\ &= \phi(v), \end{aligned}$$

where $\phi'^2(v) = 4\phi^3(v) - g_2\phi(v) + g_3$.

As in (i) it can be shewn that $e_1 = \phi(\Omega_2)$ is the greatest root of $4x^3 - g_2x + g_3 = 0$, and that

$$\Omega_2 = \int_{e_1}^\infty \frac{dx}{\sqrt{4x^3 - g_2x + g_3}}.$$

Thus $-e_1$ or e_3 is the least root of $4x^3 - g_2x - g_3 = 0$, and

$$\Omega_2 = \int_{-e_3}^\infty \frac{dx}{\sqrt{4x^3 - g_2x + g_3}}.$$

Also, as v increases from 0 to Ω_2 , $\phi(v)$ decreases from $+\infty$ to e_1 , so that $\wp(iv)$ increases continuously from $-\infty$ to e_3 .

Since $e_1 + e_2 + e_3 = 0$, and $e_1 > e_2 > e_3$, it follows that e_1 must be positive and e_3 negative.

(iii) Let $w = u + i\Omega_2$, where u is real; then, since

$$\wp(u + i\Omega_2) - e_3 = \frac{(e_1 - e_3)(e_2 - e_3)}{\wp(u) - e_3},$$

$\wp(u+i\Omega_2)$ and $\wp'(u+i\Omega_2)$ are real. As u varies from 0 to Ω_1 , $\wp(u+i\Omega_2)$ increases from e_3 to e_2 , and $\wp'(u+i\Omega_2)$ is positive. Therefore, between 0 and Ω_1 ,

$$\begin{aligned} \wp'(u+i\Omega_2) &= \sqrt{[4\{\wp(u+i\Omega_2)-e_1\}\{\wp(u+i\Omega_2)-e_2\}\{\wp(u+i\Omega_2)-e_3\}]}; \end{aligned}$$

so that

$$\Omega_1 = \int_{e_3}^{e_2} \frac{dx}{\sqrt{(4x^3 - g_2x - g_3)}}.$$

(iv) Let $w = \Omega_1 + iv$, where v is real; then, since

$$\wp(\Omega_1 + iv) - e_1 = \frac{(e_1 - e_2)(e_1 - e_3)}{\wp'(iv) - e_1},$$

$\wp(\Omega_1 + iv)$ is real and $\wp'(\Omega_1 + iv)$ is purely imaginary. As v varies from 0 to Ω_2 , $\wp(\Omega_1 + iv)$ decreases from e_1 to e_2 . Thus, if $\phi(v) = -\wp(\Omega_1 + iv)$, between 0 and Ω_2 $\phi(v)$ varies from $-e_1$ to $-e_2$ and $\phi'(v)$ is positive. Therefore, since

$$\phi'^2(v) = 4\{\phi(v) + e_1\}\{\phi(v) + e_2\}\{\phi(v) + e_3\},$$

$$\phi'(v) = \sqrt{4\phi^3(v) - g_2\phi(v) + g_3}.$$

Hence

$$\Omega_2 = \int_{-e_1}^{-e_2} \frac{dx}{\sqrt{(4x^3 - g_2x + g_3)}}.$$

Accordingly, as w passes round the rectangle OABC, $\wp(w)$ decreases continuously through all real values as follows: from $+\infty$ at O to e_1 at A; from e_1 at A to e_2 at B; from e_2 at B to e_3 at C; and from e_3 at C to $-\infty$ at O.

Let p be any real quantity, and let ξ be the point on the rectangle for which $\wp(\xi) = p$. Then, since $\wp(-\xi) = p$ and $\wp(w)$ is of order 2, every point w such that $\wp(w) = p$ must be congruent to ξ or $-\xi$. Therefore, for every point within OABC, $\wp(w)$ is imaginary or complex.

Example. Shew that

$$(i) \wp(\frac{1}{2}\Omega_1) - \wp(\frac{1}{2}\Omega_1 + i\Omega_2) = 2\sqrt{\{(e_1 - e_2)(e_1 - e_3)\}};$$

$$(ii) \wp(\frac{1}{2}\Omega_1) = -2\sqrt{\{(e_1 - e_2)(e_1 - e_3)\}}\{\sqrt{(e_1 - e_2)} + \sqrt{(e_1 - e_3)}\}.$$

78. Geometric Application.* Consider the curve given by

$$x = \wp(w), \quad y = \wp'(w),$$

or

$$y^2 = 4x^3 - g_2x - g_3.$$

* Cf. Appell et Lacour, *Fonctions Elliptiques*, §§ 58-63.

To each value of x correspond two non-congruent values $\pm w$ of the argument. But $\wp'(-w) = -\wp'(w)$; hence to each point (x, y) on the curve there corresponds only one non-congruent value of w , and the curve is symmetrical about the x -axis.

Condition that three points should be collinear. Let M_1, M_2, M_3 , be the three points in which the line $y - mx - c = 0$ cuts the curve. The corresponding values w_1, w_2, w_3 , of w are zeros of

$$\wp'(w) - m\wp(w) - c.$$

Now the only pole of this function is at the origin, and is of order 3; thus $w_1 + w_2 + w_3 = 2\lambda\omega_1 + 2\mu\omega_2$,

where λ and μ are integers.

This relation is necessary, and it is also sufficient. For, if $w_1 + w_2 + w_3 = 2\lambda\omega_1 + 2\mu\omega_2$, let the line M_1M_2 cut the curve again in the point M' of argument w' ; then

$$w_1 + w_2 + w' = 2\lambda'\omega_1 + 2\mu'\omega_2.$$

Hence w_3 and w' are congruent, so that M' coincides with M_3 .

Tangents. If the tangent at ' w_1 ' meets the curve again at ' w '

$$w + 2w_1 = 2\lambda\omega_1 + 2\mu\omega_2.$$

Thus

$$w_1 = -w/2 + \lambda\omega_1 + \mu\omega_2.$$

Accordingly, from any point ' w ' four tangents can be drawn to meet the curve in the four points whose arguments are

$$-w/2, \quad -w/2 + \omega_1, \quad -w/2 + \omega_2, \quad -w/2 + \omega_1 + \omega_2.$$

Points of Inflection. At a point of inflection

$$3w = 2\lambda\omega_1 + 2\mu\omega_2;$$

so that

$$w = \frac{2\lambda\omega_1 + 2\mu\omega_2}{3}.$$

Thus there are nine points of inflection with arguments

$$0, \frac{2\omega_1}{3}, \frac{2\omega_2}{3}, \frac{4\omega_1}{3}, \frac{4\omega_2}{3}, \frac{2\omega_1 + 2\omega_2}{3}, \frac{4\omega_1 + 2\omega_2}{3}, \frac{2\omega_1 + 4\omega_2}{3}, \frac{4\omega_1 + 4\omega_2}{3}.$$

and they lie three by three on straight lines.

Case in which ω_1 is real and ω_2 is purely imaginary. Let $\omega_1 = \Omega_1, \omega_2 = i\Omega_2$; then

$$y^2 = 4(x - e_1)(x - e_2)(x - e_3),$$

where e_1, e_2, e_3 , are real, and $e_1 > e_2 > e_3$.

As w varies along OA (Fig. 74) from 0 to Ω_1 , the point (x, y) passes up the right-hand branch of the curve of Fig. 75 from

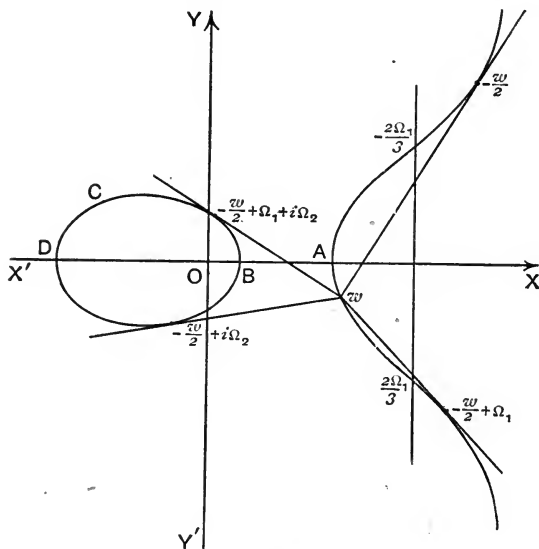

FIG. 75.

$y = -\infty$ to $A(e_1, 0)$. For values of w between Ω_1 and $\Omega_1 + i\Omega_2$, y is imaginary. As w varies from $\Omega_1 + i\Omega_2$ to $i\Omega_2$, (x, y) passes from $B(e_2, 0)$ round BCD to $D(e_3, 0)$. For values of w between $i\Omega_2$ and 0, y is imaginary. The corresponding negative values of w give the other two arcs.

There are only three real points of inflection, 0, $2\Omega_1/3$, and $-2\Omega_1/3$, the first being at infinity: they are collinear.

Example 1. Shew that the necessary and sufficient condition that the six points whose arguments are w_1, w_2, \dots, w_6 , should lie on a conic is

$$\sum_{r=1}^6 w_r = 2\lambda\omega_1 + 2\mu\omega_2.$$

Example 2. Shew that the necessary and sufficient condition that the $3n$ points w_1, w_2, \dots, w_{3n} , should lie on a curve of degree n is

$$\sum_{r=1}^{3n} w_r = 2\lambda\omega_1 + 2\mu\omega_2.$$

79. The Jacobian Elliptic Functions. Consider the three functions:

$$\phi_1(u) = e^{-\eta_1 u} \frac{\sigma(u + \omega_1)}{\sigma(\omega_1)\sigma(u)};$$

$$\phi_2(u) = e^{-(\eta_1 + \eta_2)u} \frac{\sigma(u + \omega_1 + \omega_2)}{\sigma(\omega_1 + \omega_2)\sigma(u)};$$

$$\phi_3(u) = e^{-\eta_2 u} \frac{\sigma(u + \omega_2)}{\sigma(\omega_2)\sigma(u)}.$$

They satisfy the equations:

$$\begin{aligned} \phi_1(u + 2\omega_1) &= \phi_1(u), & \phi_1(u + 2\omega_2) &= -\phi_1(u); \\ \phi_2(u + 2\omega_1) &= -\phi_2(u), & \phi_2(u + 2\omega_1 + 2\omega_2) &= \phi_2(u); \\ \phi_3(u + 2\omega_1) &= -\phi_3(u), & \phi_3(u + 2\omega_2) &= \phi_3(u). \end{aligned}$$

Again, by formula (A) of § 76,

$$\wp(u) - e_1 = \phi_1^2(u), \quad \wp(u) - e_2 = \phi_2^2(u), \quad \wp(u) - e_3 = \phi_3^2(u).$$

Thus the two values of $\sqrt{\{\wp(u) - e_1\}}$, $\sqrt{\{\wp(u) - e_2\}}$, $\sqrt{\{\wp(u) - e_3\}}$, are the uniform functions $\pm \phi_1(u)$, $\pm \phi_2(u)$, $\pm \phi_3(u)$, respectively. If those values of the three functions are taken which are large and positive when u is small and positive,

$$\sqrt{\{\wp(u) - e_1\}} = \phi_1(u), \quad \sqrt{\{\wp(u) - e_2\}} = \phi_2(u), \quad \sqrt{\{\wp(u) - e_3\}} = \phi_3(u).$$

Now $\wp'(u) = 2\phi_1(u)\phi_1'(u)$.

Also, it is easy to shew that

$$\wp'(u) = -2\phi_1(u)\phi_2(u)\phi_3(u). \quad (\text{Cf. § 76, Example 1.})$$

Hence $\phi_1'(u) = -\phi_2(u)\phi_3(u)$.

Similarly, $\phi_2'(u) = -\phi_3(u)\phi_1(u)$, $\phi_3'(u) = -\phi_1(u)\phi_2(u)$.

Next, let ω_1 be purely real and ω_2 purely imaginary, and denote them by Ω_1 and $i\Omega_2$ respectively; then, since $\wp(u) \cong e_1 > e_2 > e_3$, provided $0 < u \leq \Omega_1$,

$$\phi_1(\Omega_1) = 0, \quad \phi_2(\Omega_1) = \sqrt{(e_1 - e_2)}, \quad \phi_3(\Omega_1) = \sqrt{(e_1 - e_3)}.$$

Similarly

$$\phi_2(\Omega_1 + i\Omega_2) = 0, \quad \phi_3(\Omega_1 + i\Omega_2) = \sqrt{(e_2 - e_3)}, \quad \phi_3(i\Omega_2) = 0.$$

Accordingly, if

$$S(u) = \frac{\sqrt{(e_1 - e_3)}}{\phi_3(u)}, \quad C(u) = \frac{\phi_1(u)}{\phi_3(u)}, \quad D(u) = \frac{\phi_2(u)}{\phi_3(u)},$$

these three functions will satisfy the equations:

$$\begin{aligned} S(u + 2\Omega_1) &= -S(u), & S(u + 2i\Omega_2) &= S(u); \\ C(u + 2\Omega_1) &= -C(u), & C(u + 2i\Omega_2) &= -C(u); \\ D(u + 2\Omega_1) &= D(u), & D(u + 2i\Omega_2) &= -D(u); \end{aligned}$$

$$\frac{1}{\sqrt{(e_1 - e_3)}} S'(u) = C(u)D(u); \quad \frac{1}{\sqrt{(e_1 - e_3)}} C'(u) = -S(u)D(u);$$

$$\frac{1}{\sqrt{(e_1 - e_3)}} D'(u) = -\frac{e_2 - e_3}{e_1 - e_3} S(u)C(u);$$

$$S^2(u) + C^2(u) = 1; \quad \frac{e_2 - e_3}{e_1 - e_3} S^2(u) + D^2(u) = 1;$$

$$S(0) = 0, \quad C(0) = 1, \quad D(0) = 1;$$

$$S(\Omega_1) = 1, \quad C(\Omega_1) = 0, \quad D(\Omega_1) = \sqrt{\left(\frac{e_1 - e_2}{e_1 - e_3}\right)};$$

$$S(\Omega_1 + i\Omega_2) = \sqrt{\left(\frac{e_1 - e_3}{e_2 - e_3}\right)}, \quad D(\Omega_1 + i\Omega_2) = 0.$$

Also $S(u)$, $C(u)$, $D(u)$, have simple poles at $u = i\Omega_2$; and $S(u)$ is odd, while $C(u)$, $D(u)$, are even.

Thus $S(u)$, $C(u)$, $D(u)$, are elliptic functions of periods $4\Omega_1$, $2i\Omega_2$; $4\Omega_1$, $2\Omega_1 + 2i\Omega_2$; $2\Omega_1$, $4i\Omega_2$; respectively.

Now let $S(u) = \text{sn}(v)$, $C(u) = \text{cn}(v)$, $D(u) = \text{dn}(v)$,
where

$$v = u\sqrt{(e_1 - e_3)};$$

and let

$$K = \Omega_1\sqrt{(e_1 - e_3)}, \quad K' = \Omega_2\sqrt{(e_1 - e_3)}, \quad k = \sqrt{\left(\frac{e_2 - e_3}{e_1 - e_3}\right)}, \quad k' = \sqrt{\left(\frac{e_1 - e_2}{e_1 - e_3}\right)},$$

so that k and k' are positive proper fractions such that $k^2 + k'^2 = 1$.

Then $\text{sn}(v)$, $\text{cn}(v)$, $\text{dn}(v)$, satisfy the equations:

$$\text{sn}(v + 2K) = -\text{sn } v, \quad \text{sn}(v + 2iK') = \text{sn}(v);$$

$$\text{cn}(v + 2K) = -\text{cn } v, \quad \text{cn}(v + 2iK') = -\text{cn}(v);$$

$$\text{dn}(v + 2K) = \text{dn } v, \quad \text{dn}(v + 2iK') = -\text{dn}(v);$$

$$\text{sn}'(v) = \text{cn}(v)\text{dn}(v); \quad \text{cn}'(v) = -\text{sn}(v)\text{dn}(v);$$

$$\text{dn}'(v) = -k^2 \text{sn}(v)\text{cn}(v);$$

$$\text{sn}^2(v) + \text{cn}^2(v) = 1; \quad k^2 \text{sn}^2(v) + \text{dn}^2(v) = 1; \quad \rangle$$

$$\text{sn}(0) = 0, \quad \text{cn}(0) = 1, \quad \text{dn}(0) = 1;$$

$$\text{sn}(K) = 1, \quad \text{cn}(K) = 0, \quad \text{dn}(K) = k';$$

$$\text{sn}(K + iK') = \frac{1}{k}, \quad \text{dn}(K + iK') = 0.$$

Also $\text{sn}(v)$, $\text{cn}(v)$, $\text{dn}(v)$, have simple poles at $v = iK'$; and $\text{sn}(v)$ is odd, while $\text{cn}(v)$ and $\text{dn}(v)$ are even.

Again, since $\phi_3(u)$ or $\sqrt{(\wp(u) - e_3)}$ decreases continuously from $+\infty$ to $\sqrt{(e_1 - e_3)}$ as u increases from 0 to Ω_1 , $\text{sn}(v)$ increases

continuously from 0 to 1 as v increases from 0 to K ; accordingly, if $z = \text{sn}(v)$,

$$\frac{dz}{dv} = \text{cn } v \text{ dn } v = \sqrt{\{(1-z^2)(1-k^2z^2)\}},$$

where the positive value of the radical is taken between $z=0$ and $z=1$. Hence

$$v = \int_0^z \frac{dz}{\sqrt{\{(1-z^2)(1-k^2z^2)\}}};$$

and therefore $\text{sn}(v)$ is the inverse function of § 66. In particular,

$$K = \int_0^1 \frac{dz}{\sqrt{\{(1-z^2)(1-k^2z^2)\}}},$$

so that K is identical with the K defined there.

Moreover, since

$$\left. \begin{aligned} \Omega_1 &= \int_{e_1}^{\infty} \frac{dx}{\sqrt{\{4(x-e_1)(x-e_2)(x-e_3)\}}}, \\ \Omega_2 &= \int_{-e_3}^{\infty} \frac{dx}{\sqrt{\{4(x+e_3)(x+e_2)(x+e_1)\}}}, \end{aligned} \right\} \quad (\S 77)$$

Ω_2 can be obtained from Ω_1 by replacing e_1, e_2, e_3 , by $-e_3, -e_2, -e_1$, respectively. Thus K' is the same function of $\sqrt{\left(\frac{e_1-e_2}{e_1-e_3}\right)}$ or k' that K is of $\sqrt{\left(\frac{e_2-e_3}{e_1-e_3}\right)}$ or k ; so that K' is identical with the K' of § 66.

These three functions $\text{sn}(v)$, $\text{cn}(v)$, $\text{dn}(v)$, are the *Jacobian Elliptic Functions*; their periods are: $4K, 2iK'$; $4K, 2K+2iK'$; $2K, 4iK'$; respectively.

Since

$$\wp(u) - e_3 = \phi_3^2(u),$$

$$\wp(u) - e_3 = \frac{e_1 - e_3}{\text{sn}^2(v, k)},$$

where $v = \sqrt{(e_1 - e_3)} \cdot u$ and $k = \sqrt{\left(\frac{e_2 - e_3}{e_1 - e_3}\right)}$. This equation gives the relation between the Jacobian and the Weierstrassian elliptic functions.

Example. Invert the function

$$u = \int_0^x \frac{dx}{\sqrt{(1+x^2-2x^4)}}.$$

Ans. $x = \text{cn}(K - \sqrt{3}u, \sqrt{\frac{2}{3}})$.

Poles of $\text{sn}(v)$, $\text{cn}(v)$, $\text{dn}(v)$. From the equation

$$\sqrt{\{\wp(u) - e_3\}} = \phi_3(u)$$

it follows that

$$\sqrt{(e_1 - e_3)} = \phi_3(\Omega_1) = e^{-\eta_2 \Omega_1} \frac{\sigma(\Omega_1 + i\Omega_2)}{\sigma(\Omega_1)\sigma(i\Omega_2)}$$

and
$$\sqrt{(e_2 - e_3)} = \phi_3(\Omega_1 + i\Omega_2) = e^{-\eta_2(\Omega_1 + i\Omega_2)} \frac{\sigma(\Omega_1 + 2i\Omega_2)}{\sigma(\Omega_1 + i\Omega_2)\sigma(i\Omega_2)}.$$

Again,
$$\frac{C(u)}{S(u)} = \frac{\phi_1(u)}{\sqrt{(e_1 - e_3)}}, \quad \frac{D(u)}{S(u)} = \frac{\phi_2(u)}{\sqrt{(e_1 - e_3)}};$$

so that
$$\lim_{u \rightarrow 0} \frac{C(i\Omega_2 + u)}{S(i\Omega_2 + u)} = e^{-\eta_1 i\Omega_2} \frac{\sigma(\Omega_1 + i\Omega_2)}{\sigma(\Omega_1)\sigma(i\Omega_2)\sqrt{(e_1 - e_3)}} \\ = e^{\eta_2 \Omega_1 - \eta_1 i\Omega_2} = e^{-i\frac{\pi}{2}} = -i, \quad (\S 75)$$

and
$$\lim_{u \rightarrow 0} \frac{D(i\Omega_2 + u)}{S(i\Omega_2 + u)} = e^{-(\eta_1 + \eta_2)i\Omega_2} \frac{\sigma(\Omega_1 + 2i\Omega_2)}{\sigma(\Omega_1 + i\Omega_2)\sigma(i\Omega_2)\sqrt{(e_1 - e_3)}} \\ = \sqrt{\left(\frac{e_2 - e_3}{e_1 - e_3}\right)} e^{\eta_2 \Omega_1 - \eta_1 i\Omega_2} = -ik.$$

Accordingly, if I is the residue of $\text{sn}(v)$ at $i\Omega_2$, the residues of $\text{cn}(v)$ and $\text{dn}(v)$ at this point are $-iI$ and $-ikI$.

The function $\text{sn}(v)$ has poles at iK' and $2K + iK'$, at which the residues are I and $-I$ respectively; it is therefore of order 2. Similarly $\text{cn}(v)$ and $\text{dn}(v)$ are both of order 2.

Note. The two periods K and iK' are not, like ω_1 and ω_2 in the case of the Weierstrassian functions, independent of each other: they are connected by the relations

$$K = \int_0^1 \frac{dx}{\sqrt{\{(1-x^2)(1-k^2x^2)\}}}, \quad K' = \int_0^1 \frac{dx}{\sqrt{\{(1-x^2)(1-k'^2x^2)\}}},$$

where $k^2 + k'^2 = 1$.

Example. Prove

$$(i) E = \int_0^K \text{dn}^2(u, k) du; \quad (ii) E' = \int_0^{K'} \text{dn}^2(u, k') du.$$

80. The Addition Theorems. Consider the functions of u , $\text{sn}(u)\text{sn}(u+v)$ and $\text{cn}(u)\text{cn}(u+v) - \text{cn}(v)$: they both have periods $2K$ and $2iK'$, and simple poles at iK' and $-v + iK'$. Hence they are of order 2, with simple zeros at $u=0$ and $u=-v$; so that

$$\frac{\text{cn}(u)\text{cn}(u+v) - \text{cn}(v)}{\text{sn}(u)\text{sn}(u+v)} = C,$$

where C is a constant.

When u is small,

$$C = \frac{(1 + Au^2 + \dots)\{cn(v) - u sn(v) dn(v) + \dots\} - cn(v)}{u sn(v) + \dots}$$

$$= -dn(v) + Bu + \dots$$

Now let $u = 0$; then $C = -dn(v)$; so that

$$cn(u) cn(u + v) + sn(u) dn(v) sn(u + v) - cn(v) = 0.$$

If in this equation u and v are interchanged, it becomes

$$cn(v) cn(u + v) + sn(v) dn(u) sn(u + v) - cn(u) = 0.$$

Hence, solving these two equations for $sn(u + v)$, and writing $s_1, c_1, d_1, s_2, c_2, d_2$, in place of $sn(u), cn(u), dn(u), sn(v), cn(v), dn(v)$, respectively, we have

$$sn(u + v) = \frac{c_1^2 - c_2^2}{s_2 c_1 d_1 - s_1 c_2 d_2} = \frac{(s_1^2 - s_2^2)(s_1 c_2 d_2 + s_2 c_1 d_1)}{s_1^2 c_2^2 d_2^2 - s_2^2 c_1^2 d_1^2}$$

$$= \frac{(s_1^2 - s_2^2)(s_1 c_2 d_2 + s_2 c_1 d_1)}{(s_1^2 - s_2^2)(1 - k^2 s_1^2 s_2^2)}$$

$$= \frac{s_1 c_2 d_2 + s_2 c_1 d_1}{1 - k^2 s_1^2 s_2^2}.$$

Similarly $cn(u + v) = \frac{c_1 c_2 - s_1 s_2 d_1 d_2}{1 - k^2 s_1^2 s_2^2}.$

In like manner, by considering the functions $sn(u) sn(u + v)$ and $dn(u) dn(u + v) - dn(v)$, it can be shewn that

$$dn(u + v) = \frac{d_1 d_2 - k^2 s_1 s_2 c_1 c_2}{1 - k^2 s_1^2 s_2^2}.$$

COROLLARY. If in these formulae $-v$ is written for v , they become

$$sn(u - v) = \frac{s_1 c_2 d_2 - s_2 c_1 d_1}{1 - k^2 s_1^2 s_2^2},$$

$$cn(u - v) = \frac{c_1 c_2 + s_1 s_2 d_1 d_2}{1 - k^2 s_1^2 s_2^2},$$

$$dn(u - v) = \frac{d_1 d_2 + k^2 s_1 s_2 c_1 c_2}{1 - k^2 s_1^2 s_2^2}.$$

Example. Prove

$$\frac{sn(3u) - sn(u)}{sn(3u) + sn(u)} = \frac{sn(u) cn(2u) dn(2u)}{sn(2u) cn(u) dn(u)}.$$

Duplication Formulae. In the addition formulae make $v = u$; then, if $\operatorname{sn}(u)$, $\operatorname{cn}(u)$, $\operatorname{dn}(u)$, be written s , c , d , respectively,

$$S \equiv \operatorname{sn}(2u) = \frac{2scd}{1 - k^2 s^4},$$

$$C \equiv \operatorname{cn}(2u) = \frac{c^2 - s^2 d^2}{1 - k^2 s^4} = \frac{1 - 2s^2 + k^2 s^4}{1 - k^2 s^4},$$

$$D \equiv \operatorname{dn}(2u) = \frac{d^2 - k^2 s^2 c^2}{1 - k^2 s^4} = \frac{1 - 2k^2 s^2 + k^2 s^4}{1 - k^2 s^4}.$$

From these formulae the following can be derived:

$$\operatorname{sn}^2(u) = \frac{1 - C}{1 + D} = \frac{1}{k^2} \frac{1 - D}{1 + C} = \frac{1}{k^2} \frac{D - k^2 C - k'^2}{D - C};$$

$$\operatorname{cn}^2(u) = \frac{D + C}{1 + D} = \frac{k'^2}{k^2} \frac{1 - D}{D - C};$$

$$\operatorname{dn}^2(u) = \frac{D + C}{1 + C} = k'^2 \frac{1 - C}{D - C}.$$

Example. Shew that

$$\operatorname{sn}\left(\frac{K}{2}\right) = \sqrt{\left(\frac{1}{1+k'}\right)}, \quad \operatorname{cn}\left(\frac{K}{2}\right) = \sqrt{\left(\frac{k'}{1+k'}\right)}, \quad \operatorname{dn}\left(\frac{K}{2}\right) = \sqrt{k'}.$$

From the addition formulae it follows, since

$$\operatorname{sn}(K) = 1, \quad \operatorname{cn}(K) = 0, \quad \operatorname{dn}(K) = k',$$

that

$$\operatorname{sn}(u + K) = \frac{\operatorname{cn}(u)}{\operatorname{dn}(u)}, \quad \operatorname{cn}(u + K) = -k' \frac{\operatorname{sn}(u)}{\operatorname{dn}(u)}, \quad \operatorname{dn}(u + K) = \frac{k'}{\operatorname{dn}(u)}.$$

Hence, if u tends to iK' ,

$$\operatorname{sn}(K + iK') = \frac{1}{k'}, \quad \operatorname{cn}(K + iK') = -\frac{ik'}{k}, \quad \operatorname{dn}(K + iK') = 0.$$

Now in the addition formulae put $v = K + iK'$; then

$$\operatorname{sn}(u + K + iK') = \frac{\operatorname{dn}(u)}{k \operatorname{cn}(u)}, \quad \operatorname{cn}(u + K + iK') = -\frac{ik'}{k \operatorname{cn}(u)},$$

$$\operatorname{dn}(u + K + iK') = \frac{ik' \operatorname{sn}(u)}{\operatorname{cn}(u)}.$$

By repeated applications of these formulae the following can be derived:

$$\operatorname{sn}(u + 2K) = -\operatorname{sn}(u), \quad \operatorname{cn}(u + 2K) = -\operatorname{cn}(u),$$

$$\operatorname{dn}(u + 2K) = \operatorname{dn}(u);$$

$$\operatorname{sn}(u + 2K + 2iK') = -\operatorname{sn}(u), \quad \operatorname{cn}(u + 2K + 2iK') = \operatorname{cn}(u),$$

$$\operatorname{dn}(u + 2K + 2iK') = -\operatorname{dn}(u);$$

$$\begin{aligned} \operatorname{sn}(u + 2iK') &= \operatorname{sn}(u), & \operatorname{cn}(u + 2iK') &= -\operatorname{cn}(u), \\ \operatorname{dn}(u + 2iK') &= -\operatorname{dn}(u). \end{aligned}$$

Example. Prove $\frac{d}{du} \operatorname{sn}(u) = k'^2 \frac{\operatorname{sn}(u + K)}{\operatorname{dn}^2(u + K)}$.

Again, in the addition formulae let v tend to iK' ; then

$$\begin{aligned} \operatorname{sn}(u + iK') &= \frac{1}{k \operatorname{sn} u}, & \operatorname{cn}(u + iK') &= -\frac{i \operatorname{dn}(u)}{k \operatorname{sn}(u)}, \\ \operatorname{dn}(u + iK') &= -i \frac{\operatorname{cn}(u)}{\operatorname{sn}(u)}. \end{aligned}$$

Thus the residues of $\operatorname{sn}(u)$, $\operatorname{cn}(u)$, $\operatorname{dn}(u)$, at iK' are $1/k$, $-i/k$, $-i$, respectively.

81. Jacobi's Imaginary Transformation. Let $x = \operatorname{sn}(iu, k')$; then

$$iu = \int_0^x \frac{dx}{\sqrt{\{(1-x^2)(1-k'^2x^2)\}}}.$$

Now put $x = iy/\sqrt{1-y^2}$; then

$$u = \pm \int_0^y \frac{dy}{\sqrt{\{(1-y^2)(1-k^2y^2)\}}};$$

so that

$$y = \pm \operatorname{sn}(u, k).$$

Thus

$$\operatorname{sn}(iu, k') = \pm i \frac{\operatorname{sn}(u, k)}{\operatorname{cn}(u, k)}.$$

To determine the sign let u tend to zero; then, since

$$\lim_{u \rightarrow 0} \frac{\operatorname{sn}(iu, k')}{i \operatorname{sn}(u, k)} = 1,$$

the $+$ sign must be taken; so that

$$\operatorname{sn}(iu, k') = i \frac{\operatorname{sn}(u, k)}{\operatorname{cn}(u, k)}.$$

Again, $\operatorname{cn}(iu, k') = \sqrt{\{1 - \operatorname{sn}^2(iu, k')\}} = \pm \frac{1}{\operatorname{cn}(u, k)}$.

To determine the sign let $u = 0$; thus

$$\operatorname{cn}(iu, k') = \frac{1}{\operatorname{cn}(u, k)}.$$

Similarly

$$\operatorname{dn}(iu, k') = \frac{\operatorname{dn}(u, k)}{\operatorname{cn}(u, k)}.$$

Example. Shew that $\frac{1}{\operatorname{sn}^2(iu, k')} + \frac{1}{\operatorname{sn}^2(u, k)} = 1$.

EXAMPLES XI.

1. Prove
$$\int_0^K \frac{\operatorname{sn}^3 u \, du}{(1 + \operatorname{cn} u) \operatorname{dn}^2 u} = \frac{1}{k'^2(1+k')}.$$

2. Shew that, if $\operatorname{sn} u = \sin \phi$,

$$\int_0^u \frac{du}{1 + \operatorname{cn} u} = \frac{\operatorname{sn} u \operatorname{dn} u}{1 + \operatorname{cn} u} + u - E(k, \phi).$$

3. Prove the following identities, in which D denotes $1 - k^2 s_1^2 s_2^2$:

- (i) $\operatorname{sn}(u+v) \operatorname{sn}(u-v) = (c_2^2 - c_1^2)/D = (s_1^2 - s_2^2)/D$;
- (ii) $\{1 \pm \operatorname{cn}(u+v)\} \{1 \pm \operatorname{cn}(u-v)\} = (c_1 \pm c_2)^2/D$;
- (iii) $\{1 \pm \operatorname{dn}(u+v)\} \{1 \pm \operatorname{dn}(u-v)\} = (d_1 \pm d_2)^2/D$;
- (iv) $\operatorname{sn}(u \pm v) \operatorname{cn}(u \mp v) = (s_1 c_1 d_2 \pm s_2 c_2 d_1)/D$;
- (v) $\operatorname{sn}(u \pm v) \operatorname{dn}(u \mp v) = (s_1 d_1 c_2 \pm s_2 d_2 c_1)/D$;
- (vi) $1 + \operatorname{cn}(u+v) \operatorname{cn}(u-v) = (c_1^2 + c_2^2)/D$;
- (vii) $\operatorname{sn}(u+v) \operatorname{cn}(u-v) + \operatorname{sn}(u-v) \operatorname{cn}(u+v) = 2s_1 c_1 d_2/D$.

4. Prove
$$\frac{\operatorname{sn}\left(\frac{u+v}{2}\right) \operatorname{dn}\left(\frac{u+v}{2}\right)}{\operatorname{cn}\left(\frac{u+v}{2}\right)} = \frac{\operatorname{sn} u \operatorname{dn} v + \operatorname{sn} v \operatorname{dn} u}{\operatorname{cn} u + \operatorname{cn} v}.$$

5. Shew that, with the notation of *Example 3*,

$$\begin{vmatrix} \operatorname{sn}^2(u+v) & \operatorname{sn}(u+v) \operatorname{sn}(u-v) & \operatorname{sn}^2(u-v) \\ \operatorname{cn}^2(u+v) & \operatorname{cn}(u+v) \operatorname{cn}(u-v) & \operatorname{cn}^2(u-v) \\ \operatorname{dn}^2(u+v) & \operatorname{dn}(u+v) \operatorname{dn}(u-v) & \operatorname{dn}^2(u-v) \end{vmatrix} = \frac{-8k'^2 s_1 s_2^3 c_1 c_2 d_1 d_2}{D^3}.$$

6. Verify the identity

$$k^2 k'^2 S - k^2 C + D - k^2 = 0,$$

where

$$\begin{aligned} S &= \operatorname{sn}(u+v) \operatorname{sn}(u-v) \operatorname{sn}(u+w) \operatorname{sn}(u-w), \\ C &= \operatorname{cn}(u+v) \operatorname{cn}(u-v) \operatorname{cn}(u+w) \operatorname{cn}(u-w), \\ D &= \operatorname{dn}(u+v) \operatorname{dn}(u-v) \operatorname{dn}(u+w) \operatorname{dn}(u-w). \end{aligned}$$

7. If $S = \operatorname{sn} u \operatorname{sn}(u+K)$, verify that:

- (i) $\frac{dS}{du} = \frac{1}{k^2} \{ \operatorname{dn}^2 u - \operatorname{dn}^2(u+K) \}$;
- (ii) $\{ \operatorname{dn} u + \operatorname{dn}(u+K) \}^2 + k^4 S^2 = (1+k')^2$;
- (iii) $\{ \operatorname{dn} u - \operatorname{dn}(u+K) \}^2 + k^4 S^2 = (1-k')^2$.

Deduce that
$$(1+k')S = \operatorname{sn}\left\{u(1+k'), \frac{1-k'}{1+k'}\right\}.$$

8. Shew that the function of u ,

$$\operatorname{sn} u \operatorname{cn} u \operatorname{dn} u (\operatorname{sn}^2 v - \operatorname{sn}^2 w) + \operatorname{sn} v \operatorname{cn} v \operatorname{dn} v (\operatorname{sn}^2 w - \operatorname{sn}^2 u) + \operatorname{sn} w \operatorname{cn} w \operatorname{dn} w (\operatorname{sn}^2 u - \operatorname{sn}^2 v),$$

has periods $2K$ and $2iK'$; and prove that $u = iK' - v - w$ is a simple zero.

9. Prove that the function of u ,

$$\operatorname{sn}^4 u (\operatorname{sn}^2 v - \operatorname{sn}^2 w) + \operatorname{sn}^4 v (\operatorname{sn}^2 w - \operatorname{sn}^2 u) + \operatorname{sn}^4 w (\operatorname{sn}^2 u - \operatorname{sn}^2 v),$$

has periods $2K$ and $2iK'$; and shew that it has four simple non-congruent zeros, $\pm v, \pm w$.

10. Verify that

$$\{1 - (1+k') \operatorname{sn} u \operatorname{sn}(u+K)\} \{1 - (1-k') \operatorname{sn} u \operatorname{sn}(u+K)\} = \{\operatorname{sn}(u+K) - \operatorname{sn} u\}^2.$$

11. Prove

$$\frac{1 - \operatorname{dn}(2u)}{1 + \operatorname{dn}(2u)} = k^2 \frac{s^2 c^2}{d^2}.$$

12. Prove

$$\operatorname{dn}(u, k) = k' \operatorname{sn}(K' - iK - iu, k').$$

13. Let $w = \operatorname{sn}^2(z, k)$, and let A, B, C, be the points K, $K + iK'$, iK' , respectively, in the z -plane. Shew that, as z passes round the rectangle COAB, w passes through all real values from $-\infty$ to $+\infty$. If COAB is a square, what is the value of k ? Ans. $1/\sqrt{2}$.

14. The coordinates of two points are connected by the equation

$$X + iY = \frac{\operatorname{cn}(x + iy)}{1 + \operatorname{sn}(x + iy)}.$$

Shew that, as (x, y) describes the boundary of the rectangle COAB of the previous example, (X, Y) describes the complete boundary of a quadrant of a circle of unit radius.

15. Prove

$$\frac{1}{\operatorname{dn}(u+v)} + \frac{1}{\operatorname{dn}(u-v)} = \frac{2d_1 d_2}{k'^2 + k^2 c_1^2 c_2^2}.$$

16. Prove

$$\frac{1}{\operatorname{cn}(u+v)} + \frac{1}{\operatorname{cn}(u-v)} = \frac{2k^2 c_1 c_2}{d_1^2 d_2^2 - k'^2}.$$

17. Shew that

$$(i) \lim_{u \rightarrow 0} \frac{\operatorname{sn}^2 u}{1 - \operatorname{cn} u \operatorname{dn} u} = \frac{2}{1 + k^2}; \quad (ii) \lim_{u \rightarrow 0} \frac{u - \operatorname{sn} u}{u^3} = \frac{1 + k^2}{6};$$

$$(iii) \lim_{u \rightarrow 0} \frac{u \operatorname{dn} u - \operatorname{sn} u}{u^2 \operatorname{sn} u} = \frac{1 - 2k^2}{6}.$$

18. Establish the expansions

$$\operatorname{sn} u = u - \frac{1}{6}(1 + k^2)u^3 + \frac{1}{120}(1 + 14k^2 + k^4)u^5 + \dots,$$

$$\operatorname{cn} u = 1 - \frac{1}{2}u^2 + \frac{1}{24}(1 + 4k^2)u^4 + \dots,$$

$$\operatorname{dn} u = 1 - \frac{1}{2}k^2 u^2 + \frac{1}{24}(4k^2 + k^4)u^4 + \dots,$$

where $|u| < K'$.

19. If the tangents from the point P on the cubic $x = \wp(w)$, $y = \wp'(w)$, meet the curve in A, B, C, D, shew that the pairs of lines: AB, CD; AC, BD; AD, BC; intersect at points Q, R, S, on the curve; also shew that the tangents at P, Q, R, S, intersect at a point on the curve.

CHAPTER XII.

LINEAR DIFFERENTIAL EQUATIONS.

82. Continuation of a Function by Successive Elements.

Let $P(z, a)$ denote a Taylor Series $\sum_0^{\infty} c_n(z-a)^n$ with circle of convergence C ; then, if z_1 is any point within C , this function can be expanded at z_1 in a Taylor Series $\sum_0^{\infty} c'_n(z-z_1)^n$, which we denote by $P_1(z, z_1)$. The circle of convergence C_1 of this series will either touch C internally or lie partly outside C : in the latter case $P_1(z, z_1)$ gives the continuation of $P(z, a)$ in the part of C_1 outside C (§ 55, Th. II. Cor.). The two expressions $P(z, a)$ and $P_1(z, z_1)$ are called *Elements* of the function. The radius of C_1 will be the distance from z_1 to the nearest singularity of the function; so that, if C_1 touches C internally, the point of contact must be a singular point.

It may happen that no part of the circumference of C can be found, however small, which does not contain singularities of the function: in this case the function cannot be continued beyond C . If, on the other hand, the function can be continued beyond C , the process can be repeated with each new domain so attained. The aggregate of the elements thus obtained defines an *Analytic Function*.

Note 1. If the only singularity of the function is at infinity, the original element gives the complete function.

Note 2. If $f(z)$ is holomorphic at infinity, the corresponding element is obtained by continuing $f(1/\xi)$ to a domain of centre $\xi=0$.

A particular point b can usually be approached by different continuations from a ; and it is possible that the function may thus attain different values at b . If the values are always the

same, the function is uniform. The case of multiform functions requires more particular investigation.

Join a and b by a path L : on L take points a, z_1, z_2, z_3, \dots , such that each point lies in the domain of the preceding one. Then the corresponding elements give a value of the function at each point on L . If no singularity lies on L , the points z_1, z_2, z_3, \dots , can be chosen so that, after a finite number of steps, a domain is reached which contains b , and thus a value of the function at b is obtained.

This value is independent of the set of points z_1, z_2, z_3, \dots , selected. For, let a set of points $z_{n_1}, z_{n_2}, \dots, z_{n_r}$, be interpolated on that arc of L which joins z_n and z_{n+1} ; then, if the elements corresponding to these points are employed in the process of continuation, the same value is attained at z_{n+1} , since the arc lies entirely in the domain of z_n (§55, Th. II. Cor.). Now, any two sets of dividing points, z_1, z_2, z_3, \dots , and z'_1, z'_2, z'_3, \dots , can be combined, and other points, if necessary, interpolated between them, in order that each point of the new set may lie in the domain of the preceding one. Hence it follows that each of the original sets gives rise to the same functional value at b . Thus, if the function varies along a line which does not pass through a singularity, the set of values obtained at points on the line is always the same.

Again, since the points z_1, z_2, z_3, \dots , can be chosen so that each not only lies in the domain of the preceding point, but also in the domain of the succeeding point, it follows that, if the value at b be taken as initial value, and if the path L be retraced from b to a , the same set of values will be obtained at all points of the line.

Finally, if any two paths L and L' are drawn from a to b , such that no singularity lies between them, they will lead to the same value at b ; for otherwise the closed contour made up of L taken from b to a , and of L' taken from a to b , would enclose at least one branch-point of the function, which contradicts our hypothesis.

83. Homogeneous Linear Differential Equations. A linear differential equation

$$\frac{d^n w}{dz^n} = p_1(z) \frac{d^{n-1} w}{dz^{n-1}} + p_2(z) \frac{d^{n-2} w}{dz^{n-2}} + \dots + p_n(z) w,$$

which involves no terms independent of w , is said to be *Homogeneous*. We shall assume that the coefficients are uniform functions with no singularities except poles in the region considered. A point which is an ordinary point for all the coefficients is called an *ordinary point* of the differential equation, while a point which is a singularity of any one of the coefficients is called a *singularity* of the equation. If ξ is an ordinary point, and if a is the singularity of the equation nearest to ξ , the interior of the circle $|z - \xi| = |a - \xi|$ is called the *domain* of ξ .

If the equation is of the first order, its solution is

$$w = Ce^{\int p_1(z) dz},$$

where C is an arbitrary constant. Accordingly, it is only necessary to consider equations of order higher than the first. We shall, indeed, confine our attention to equations of the second order; but the methods employed can be applied, with suitable modifications, to equations of higher order.

THEOREM. In the domain of an ordinary point ξ the differential equation

$$\frac{d^2 w}{dz^2} = p(z) \frac{dw}{dz} + q(z)w \quad (\text{A})$$

possesses a unique integral $w(z)$, which is a holomorphic function, and which, with its first derivative, acquires arbitrarily assigned values (the *initial values*) when $z = \xi$.

Let M_1 and M_2 be greater than or equal to the greatest values of $|p(z)|$ and $|q(z)|$ on the circle $|z - \xi| = R$, where $R < |a - \xi|$ and a is the nearest singularity of the equation to ξ . Then (§ 35, Cor. 1) the functions

$$\phi(z) = \frac{M_1}{1 - \frac{z - \xi}{R}}, \quad \psi(z) = \frac{M_2}{1 - \frac{z - \xi}{R}},$$

satisfy the inequalities

$$\left| \frac{d^n p(\xi)}{d\xi^n} \right| \leq \left\{ \frac{d^n \phi(z)}{dz^n} \right\}_{z=\xi}, \quad \left| \frac{d^n q(\xi)}{d\xi^n} \right| \leq \left\{ \frac{d^n \psi(z)}{dz^n} \right\}_{z=\xi}, \quad (\text{B})$$

where $n = 0, 1, 2, \dots$. The functions $\phi(z)$ and $\psi(z)$ are called *Dominant Functions*, and the equation

$$\frac{d^2 W}{dz^2} = \phi(z) \frac{dW}{dz} + \psi(z)W \quad (\text{C})$$

is called the *Dominant Equation*.

Now, if a function $w(z)$ is holomorphic in the domain of ξ , it can be expressed in that region in the form of a convergent series

$$c_0 + c_1(z - \xi) + c_2(z - \xi)^2 + \dots, \tag{I}$$

where
$$c_n = \frac{1}{n!} \frac{d^n w(\xi)}{d\xi^n}, \quad (n = 0, 1, 2, \dots).$$

But if this function $w(z)$ is an integral of equation (A), and if arbitrary values have been assigned to $w(\xi)$ and $w'(\xi)$, the corresponding value of $w''(\xi)$ can be obtained by substituting ξ for z in the equation. Likewise, if the equation is differentiated repeatedly, and ξ substituted for z , equations

$$\begin{aligned} w^{(n)}(\xi) = & p(\xi)w^{(n-1)}(\xi) + {}_{n-2}C_1 p'(\xi)w^{(n-2)}(\xi) + \dots \\ & + {}_{n-2}C_{n-2} p^{(n-2)}(\xi)w'(\xi) + q(\xi)w^{(n-2)}(\xi) \\ & + {}_{n-2}C_1 q'(\xi)w^{(n-3)}(\xi) + \dots + {}_{n-2}C_{n-2} q^{(n-2)}(\xi)w(\xi), \end{aligned} \tag{D}$$

are obtained for $n = 3, 4, 5, \dots$; thus the coefficients c_0, c_1, c_2, \dots , can be found.

Similarly, if $W(z)$ is a solution of equation (c), holomorphic within $|z - \xi| = R$,

$$W(z) = c_0' + c_1'(z - \xi) + c_2'(z - \xi)^2 + \dots, \tag{II}$$

where
$$c_n' = \frac{1}{n!} \frac{d^n W(\xi)}{d\xi^n},$$

and

$$\begin{aligned} W^{(n)}(\xi) = & \phi(\xi)W^{(n-1)}(\xi) + {}_{n-2}C_1 \phi'(\xi)W^{(n-2)}(\xi) + \dots \\ & + {}_{n-2}C_{n-2} \phi^{(n-2)}(\xi)W'(\xi) + \psi(\xi)W^{(n-2)}(\xi) \\ & + {}_{n-2}C_1 \psi'(\xi)W^{(n-3)}(\xi) + \dots + {}_{n-2}C_{n-2} \psi^{(n-2)}(\xi)W(\xi). \end{aligned} \tag{E}$$

Now let $|w(\xi)|$ and $|w'(\xi)|$ be assigned as initial values to $W(\xi)$ and $W'(\xi)$; then, from equations (A), (B), (C), (D), and (E), it follows that, for all values of n , $W^{(n)}(\xi)$ is real and positive, and

$$|w^{(n)}(\xi)| \leq W^{(n)}(\xi).$$

Accordingly, if the series (II) can be proved to be convergent, the series (I) will also be convergent, and $w(z)$ will be holomorphic in the domain of ξ .

Let $z - \xi = RZ$; then

$$W(z) = c_0'' + c_1''Z + c_2''Z^2 + \dots, \tag{III}$$

where $c_n'' = R^n c_n'$; and equation (c) becomes

$$(1-Z) \frac{d^2 W}{dZ^2} = R M_1 \frac{dW}{dZ} + R^2 M_2 W,$$

so that $(1-Z) \frac{d^{n+2} W}{dZ^{n+2}} - n \frac{d^{n+1} W}{dZ^{n+1}} = R M_1 \frac{d^{n+1} W}{dZ^{n+1}} + R^2 M_2 \frac{d^n W}{dZ^n}$.

In this equation put $Z=0$; then, since

$$\left(\frac{d^n W}{dZ^n} \right)_{Z=0} = n! c_n'',$$

we have $c_{n+2}'' = \frac{n + R M_1}{n + 2} c_{n+1}'' + \frac{R^2 M_2}{(n+1)(n+2)} c_n''$.

Now let M_1 be chosen so great that $R M_1 > 2$; then $c_{n+2}'' > c_{n+1}''$, so that $c_n''/c_{n+1}'' < 1$.

But $\frac{c_{n+2}''}{c_{n+1}''} = \frac{n + R M_1}{n + 2} + \frac{R^2 M_2}{(n+1)(n+2)} \frac{c_n''}{c_{n+1}''}$;

therefore $\lim_{n \rightarrow \infty} \frac{c_{n+2}''}{c_{n+1}''} = 1$.

Thus series (III) converges if $|Z| < 1$; hence series (II), and consequently series (I), converges if $|z - \xi| < R$.

Now, if z is any point in the domain of ξ , R can be chosen so that $|z - \xi| < R < |a - \xi|$. Accordingly an integral $w(z)$ exists, which is holomorphic in the domain of ξ , and is such that arbitrary values can be assigned to $w(\xi)$ and $w'(\xi)$.

COROLLARY 1. The integral is unique. For, if any particular values are assigned to $w(\xi)$ and $w'(\xi)$, only one set of values for c_2, c_3, c_4, \dots , can be deduced from equations (A) and (D).

COROLLARY 2. The integral is of the form $c_0 w_1(z) + c_1 w_2(z)$, where c_0, c_1 , are arbitrary constants, and $w_1(z), w_2(z)$, are integrals of the equation. For, by means of equations (A) and (D), all the constants c_2, c_3, c_4, \dots , can be expressed linearly in terms of c_0 and c_1 . Also, by making c_0 and c_1 zero in turn, we see that $w_1(z)$ and $w_2(z)$ are integrals of the equation.

Integrals at Infinity. To determine whether infinity is an ordinary point of the equation, the transformation $z = 1/\xi$ is employed. The equation then becomes

$$\frac{d^2 w}{d\xi^2} = - \left\{ \frac{p(1/\xi)}{\xi^2} + \frac{2}{\xi} \right\} \frac{dw}{d\xi} + \frac{q(1/\xi)}{\xi^4} w;$$

so that it is necessary that $p(z) + 2/z$ and $q(z)$ should have zeros of orders 2 and 4 respectively at infinity. If this condition is fulfilled, holomorphic integrals $w(\xi)$ or $w(1/z)$ can be found.

Analytical Continuation of the Integral. Let ξ' be any point in the domain of ξ , and let $P(z, \xi')$ be the element of the integral $w(z)$ corresponding to the domain of ξ' . Then, since the function

$$\frac{d^2}{dz^2} P(z, \xi') - p(z) \frac{d}{dz} P(z, \xi') - q(z) P(z, \xi')$$

vanishes at all points common to the domains of ξ and ξ' , it vanishes at all points of the domain of ξ' (§55, Th. III.); thus $P(z, \xi')$ satisfies the differential equation, and has the initial values $w(\xi')$ and $w'(\xi')$ at ξ' . Similarly it can be shewn that every element obtained from $w(z)$ by analytical continuation satisfies the equation.

84. Solution by Infinite Series. An integral $w(z)$ can be obtained by assigning values to c_0 and c_1 and then finding c_2, c_3, c_4, \dots , by means of equations (A) and (D) (§83). In practice, however, it is usually simpler to proceed as follows:

(i) if an integral in the domain of $z=0$ is required, substitute the series

$$c_0 + c_1 z + c_2 z^2 + \dots$$

for w in equation (A), and equate the coefficients of powers of z ; a series of equations is thus obtained which enables us to determine c_2, c_3, c_4, \dots , in terms of c_0 and c_1 ;

(ii) if an integral in the domain of any point a is required, apply the transformation $z = a + \xi$ to the equation, and use method (i);

(iii) an integral in the domain of infinity can be obtained by applying the transformation $z = 1/\xi$ and using method (i); it is, however, simpler to substitute the series $\sum_0^{\infty} c_n/z^n$ in the equation and equate coefficients.

Note. The theorem proved in the previous section, and the method of solution just given, apply also to equations of higher order than the second.

Legendre's Equation. Consider the equation

$$(1 - z^2) \frac{d^2 w}{dz^2} - 2z \frac{dw}{dz} + n(n+1)w = 0.$$

Here $p(z) = 2z/(1 - z^2)$ and $q(z) = -n(n+1)/(1 - z^2)$; thus $z=0$

is an ordinary point of the equation, its domain being the interior of the circle $|z|=1$.

Let $w = c_0 + c_1 z + c_2 z^2 + \dots$
be substituted in the equation; then

$$(1-z^2) \sum_{\nu=2}^{\infty} \nu(\nu-1)c_{\nu} z^{\nu-2} - 2z \sum_{\nu=1}^{\infty} \nu c_{\nu} z^{\nu-1} + n(n+1) \sum_{\nu=0}^{\infty} c_{\nu} z^{\nu} = 0;$$

so that

$$2 \cdot 1 \cdot c_2 + n(n+1)c_0 = 0,$$

$$3 \cdot 2 \cdot c_3 - 2c_1 + n(n+1)c_1 = 0,$$

$$(\nu+2)(\nu+1)c_{\nu+2} - \nu(\nu-1)c_{\nu} - 2\nu c_{\nu} + n(n+1)c_{\nu} = 0, \quad (\nu=2, 3, 4, \dots).$$

Hence

$$c_2 = -\frac{n(n+1)}{1 \cdot 2} c_0,$$

$$c_3 = -\frac{(n-1)(n+2)}{2 \cdot 3} c_1,$$

$$c_{\nu+2} = -\frac{(n-\nu)(n+\nu+1)}{(\nu+1)(\nu+2)} c_{\nu}, \quad (\nu=2, 3, 4, \dots)$$

Therefore $w = c_0 w_1 + c_1 w_2$, where

$$w_1 = F\left(-\frac{n}{2}, \frac{n+1}{2}, \frac{1}{2}, z^2\right), \quad w_2 = zF\left(-\frac{n-1}{2}, \frac{n+2}{2}, \frac{3}{2}, z^2\right).$$

If n is an even positive integer, the first, and if n is an odd positive integer, the second of these series contains only a finite number of terms; so that, if n is a positive integer, one integral is a polynomial.

Now, if n is even,

$$\begin{aligned} F\left(-\frac{n}{2}, \frac{n+1}{2}, \frac{1}{2}, z^2\right) &= (-1)^{\frac{n}{2}} \frac{(2n)! \left(\frac{n}{2}!\right)^2}{(n!)^3} \left\{ z^n - \frac{n(n-1)}{2(2n-1)} z^{n-2} \right. \\ &\quad \left. + \frac{n(n-1)(n-2)(n-3)}{2 \cdot 4 \cdot (2n-1)(2n-3)} z^{n-4} - \dots \right\} \\ &= (-1)^{\frac{n}{2}} \frac{2^n \left(\frac{n}{2}!\right)^2}{n!} P_n(z); \quad (\S 54, \text{Cor.}) \end{aligned}$$

while, if n is odd,

$$zF\left(-\frac{n-1}{2}, \frac{n+2}{2}, \frac{3}{2}, z^2\right) = (-1)^{\frac{n-1}{2}} \frac{2^{n-1} \left(\frac{n-1}{2}!\right)^2}{n!} P_n(z).$$

Thus, if n is a positive integer, one integral is the Legendre Polynomial $P_n(z)$, which is also known as *Legendre's Function of the First Kind*.

Example. Find integrals for

$$\frac{d^2w}{dz^2} + zw = 0.$$

$$\text{Ans. } w_1 = 1 - \frac{1}{3!}z^3 + \frac{1.4}{6!}z^6 - \frac{1.4.7}{9!}z^9 + \dots,$$

$$w_2 = \frac{1}{1!}z - \frac{2}{4!}z^4 + \frac{2.5}{7!}z^7 - \frac{2.5.8}{10!}z^{10} + \dots$$

85. Fundamental System of Integrals.

THEOREM I. The integral $w(z)$ of equation (A), § 83, cannot have a zero of the second order at any ordinary point of the equation, unless it vanishes identically.

For if it has a zero of the second order at the point z , $w(z) = 0$ and $w'(z) = 0$; hence the equation gives $w''(z) = 0$. Similarly, if the equation is differentiated repeatedly, it follows that

$$w'''(z) = 0, \quad w^{iv}(z) = 0, \quad \dots, \quad w^{(n)}(z) = 0, \quad \dots;$$

so that the integral is identically zero.

THEOREM II. If $w_1(z)$, $w_2(z)$, $w_3(z)$, are integrals of the differential equation holomorphic in the domain of ζ , a relation of the form

$$c_1w_1(z) + c_2w_2(z) + c_3w_3(z) = 0$$

exists, where c_1 , c_2 , c_3 are constants not all zero.

For if c_1 , c_2 , c_3 , be chosen to satisfy the two equations

$$c_1w_1(\zeta) + c_2w_2(\zeta) + c_3w_3(\zeta) = 0,$$

$$c_1w_1'(\zeta) + c_2w_2'(\zeta) + c_3w_3'(\zeta) = 0,$$

the integral $w(z) = c_1w_1(z) + c_2w_2(z) + c_3w_3(z)$ and its first derivative vanish when $z = \zeta$. Hence, by Theorem I, $w(z)$ is identically zero; so that

$$c_1w_1(z) + c_2w_2(z) + c_3w_3(z) = 0.$$

DEFINITIONS. Two integrals are said to be *linearly independent* if their quotient is not a constant. Two linearly independent integrals are said to form a *Fundamental System of Integrals*. Such a system can always be obtained by making

$$w_1(\zeta) = 1, \quad w_1'(\zeta) = 0, \quad w_2(\zeta) = 0, \quad w_2'(\zeta) = 1.$$

From Theorem II. it follows that if the integrals $w_1(z)$ and $w_2(z)$ form a fundamental system, any integral can be expressed in the form $c_1w_1(z) + c_2w_2(z)$, where c_1 and c_2 are constants.

Again, if $c_1 w_1(z) + c_2 w_2(z) = 0$, then $\Delta(z) = 0$, where

$$\Delta(z) = \begin{vmatrix} w_1'(z), & w_1(z) \\ w_2'(z), & w_2(z) \end{vmatrix}.$$

Conversely, if $\Delta(z) = 0$, a relation $c_1 w_1(z) + c_2 w_2(z) = 0$ exists: for, if $\Delta(z) = 0$,

$$\frac{w_1'(z)}{w_1(z)} = \frac{w_2'(z)}{w_2(z)},$$

and the integral of this equation gives a relation of the type required.

THEOREM III. If the integrals $w_1(z)$ and $w_2(z)$ form a fundamental system in the domain of ξ , $\Delta(z)$ cannot vanish in that domain.

For let $W_1(z)$, $W_2(z)$, be another fundamental system; then

$$W_1(z) = c_{11} w_1(z) + c_{12} w_2(z), \quad W_2(z) = c_{21} w_1(z) + c_{22} w_2(z);$$

so that

$$\begin{vmatrix} W_1'(z), & W_1(z) \\ W_2'(z), & W_2(z) \end{vmatrix} = D \Delta(z),$$

where

$$D = \begin{vmatrix} c_{11}, & c_{21} \\ c_{12}, & c_{22} \end{vmatrix}.$$

The determinant D cannot vanish, since $W_1(z)$ and $W_2(z)$ are linearly independent. But $W_1(z)$ and $W_2(z)$ can always be chosen so that, at any assigned point z in the region,

$$W_1(z) = 1, \quad W_1'(z) = 0, \quad W_2(z) = 0, \quad W_2'(z) = 1.$$

Hence $\Delta(z)$ is non-zero at every point of the region.

THEOREM IV. If two linearly independent functions $w_1(z)$ and $w_2(z)$ are holomorphic in the neighbourhood of ξ , and are such that $\Delta(\xi) \neq 0$, a homogeneous linear differential equation of the second order can be constructed, of which they are integrals, and of which ξ is an ordinary point.

For if the functions $p(z)$ and $q(z)$ are defined by the two equations

$$w_1''(z) - p(z)w_1'(z) - q(z)w_1(z) = 0,$$

$$w_2''(z) - p(z)w_2'(z) - q(z)w_2(z) = 0,$$

then

$$p(z) = \Delta_1(z)/\Delta(z), \quad q(z) = -\Delta_2(z)/\Delta(z),$$

where $\Delta_1(z) = \begin{vmatrix} w_1''(z), & w_1(z) \\ w_2''(z), & w_2(z) \end{vmatrix}$, $\Delta_2(z) = \begin{vmatrix} w_1''(z), & w_1'(z) \\ w_2''(z), & w_2'(z) \end{vmatrix}$.

Now the numerators and denominators of these two fractions are holomorphic, and $\Delta(\xi) \neq 0$; hence $p(z)$ and $q(z)$ are holomorphic near $z = \xi$. Accordingly $w_1(z)$ and $w_2(z)$ are integrals of the equation

$$w'' = p(z)w' + q(z)w,$$

of which ξ is an ordinary point.

Example. Find an equation which is satisfied by

$$w_1 = z, \quad w_2 = 1 + \frac{z^2}{2!} - \frac{1 \cdot z^4}{4!} + \frac{1 \cdot 3 \cdot z^6}{6!} - \frac{1 \cdot 3 \cdot 5 \cdot z^8}{8!} + \dots$$

Ans. $w'' = -zw' + w.$

EXAMPLES XII.

1. Find integrals w_1, w_2 , for $w'' + a^2w = 0$, such that, when $z=0, w_1=1, w_1'=0, w_2=0, w_2'=1.$

Ans. $w_1 = \cos az, w_2 = a^{-1} \cdot \sin az.$

Find integrals in the domain of $z=0$ for equations 2-10.

2. $(1 - z^3)w'' - z^2w' + zw = 0.$

Ans. $w_1 = z, w_2 = 1 - \frac{z^3}{2 \cdot 3} - \frac{4}{3} \frac{z^6}{5 \cdot 6} - \frac{4 \cdot 7}{3 \cdot 6} \frac{z^9}{8 \cdot 9} - \dots$

3. $(z^2 - k^2)w'' + zw' - w = 0.$

Ans. $w_1 = z, w_2 = \sqrt{(k^2 - z^2)}.$

4. $(1 + z + z^2)w'' + 2(1 + 2z)w' + 2w = 0.$

Ans. $w_1 = \frac{1}{1 + z + z^2}, w_2 = \frac{z}{1 + z + z^2}.$

5. $(z - 1)(z - 2)w'' - (2z - 3)w' + 2w = 0.$

Ans. $w_1 = 2 - z^2, w_2 = 4z - 3z^2.$

6. $(1 + z^2)w'' - zw' + w = 0.$

Ans. $w_1 = z, w_2 = F(-\frac{1}{2}, -\frac{1}{2}, \frac{1}{2}, -z^2).$

7. $(1 - z^2)w'' - zw' + a^2w = 0.$

Ans. $w_1 = F\left(\frac{\alpha}{2}, -\frac{\alpha}{2}, \frac{1}{2}, z^2\right), w_2 = zF\left(\frac{1+\alpha}{2}, \frac{1-\alpha}{2}, \frac{3}{2}, z^2\right).$

8. $(1 - z^2)w'' - (2n + 1)zw' + m(m + 2n)w = 0.$

Ans. $w_1 = F\left(\frac{m}{2} + n, -\frac{m}{2}, \frac{1}{2}, z^2\right), w_2 = zF\left(\frac{1+m}{2} + n, \frac{1-m}{2}, \frac{3}{2}, z^2\right).$

9. $(1 - z^3)w''' + 2zw' - 4w = 0.$

Ans. $w_1 = z^2, w_2 = F(-\frac{2}{3}, -\frac{2}{3}, \frac{2}{3}, z^3), w_3 = zF(-\frac{1}{3}, -\frac{1}{3}, \frac{4}{3}, z^3).$

10. $w'' - z^2w'' + 2zw' - 2w = 0.$

Ans. $w_1 = z, w_2 = z^2, w_3 = 1 + \frac{2z^3}{1! \cdot 3 \cdot 1 \cdot 2} + \frac{2z^6}{2! \cdot 3^2 \cdot 4 \cdot 5} + \frac{2z^9}{3! \cdot 3^3 \cdot 7 \cdot 8} + \dots$

11. Find integrals in the domain of $z=1$ for $z(2 - z)w'' + 2w = 0.$

Ans. $w_1 = z(2 - z), w_2 = 2(z - 1) + z(2 - z) \log \{z/(2 - z)\}.$

12. Find integrals in the domain of $z = -1$ for $w'' - (1 + z)w' - w = 0.$

Ans. $w_1 = e^{\frac{(1+z)^2}{2}}, w_2 = \frac{(1+z)}{1} + \frac{(1+z)^3}{1 \cdot 3} + \frac{(1+z)^5}{1 \cdot 3 \cdot 5} + \dots$

Find integrals in the domain of infinity for equations 13-15.

13. $z^4 w'' = (1 - 2z)z^2 w' + 2w.$

Ans. $w_1 = e^{1/z}, w_2 = e^{-2/z}.$

14. $z^4 w'' + 2z^3 w' + a^2 w = 0.$

Ans. $w_1 = \cos(a/z), w_2 = \sin(a/z).$

15. $z^2(z^2 - 1)w'' + 2z(z^2 + 1)w' - 2w = 0.$

Ans. $w_1 = z^2/(z^2 - 1), w_2 = z/(z^2 - 1).$

16. Find an equation which is satisfied by

$$w_1 = 1 + z^2, w_2 = z + \frac{z^3}{1.3} - \frac{z^5}{3.5} + \frac{z^7}{5.7} - \dots$$

Ans. $(1 + z^2)w'' - 2w = 0.$

17. Find an equation which is satisfied by $w_1 = z, w_2 = e^z.$

Ans. $(z - 1)w'' - zw' + w = 0.$

18. Shew that, if n is a positive integer, the equation

$$(z^2 - 1)w'' = n(n + 1)w$$

has integrals $P(z)$ and $P(z) \log\left(\frac{z+1}{z-1}\right) + Q(z)$, where $P(z)$ and $Q(z)$ are polynomials of degrees $n + 1$ and n respectively.

CHAPTER XIII.

REGULAR INTEGRALS OF LINEAR DIFFERENTIAL EQUATIONS.

86. Integrals in the Neighbourhood of a Singularity.

Consider a homogeneous linear differential equation of the second order, of which ξ is a singularity and of which w_1, w_2 , form a fundamental system of integrals at z . Let z describe a closed circuit which encloses ξ but no other singularity of the equation, and let \bar{w}_1 and \bar{w}_2 be the analytical continuations of w_1 and w_2 obtained when the variable has completed the circuit. These two integrals \bar{w}_1, \bar{w}_2 , form a fundamental system; for, if not, a relation $c_1\bar{w}_1 + c_2\bar{w}_2 = 0$ would exist. Consequently the function $c_1\bar{w}_1 + c_2\bar{w}_2$ would vanish at all points to which it can be continued (§ 55, Th. III.); and therefore, retracing the circuit, we would obtain the relation $c_1w_1 + c_2w_2 = 0$, which contradicts our hypothesis. Accordingly

$$\bar{w}_1 = c_{11}w_1 + c_{12}w_2, \quad \bar{w}_2 = c_{21}w_1 + c_{22}w_2,$$

where
$$D = \begin{vmatrix} c_{11} & c_{12} \\ c_{21} & c_{22} \end{vmatrix} \neq 0.$$

Now let $W = \lambda w_1 + \mu w_2$, and choose the constants λ, μ , so that \bar{W} , the value attained by W after the description of the closed circuit, satisfies the equation $\bar{W} = \rho W$, where ρ is a constant; then

$$\begin{aligned} \lambda\bar{w}_1 + \mu\bar{w}_2 &= \lambda(c_{11}w_1 + c_{12}w_2) + \mu(c_{21}w_1 + c_{22}w_2) \\ &= \rho(\lambda w_1 + \mu w_2). \end{aligned}$$

Therefore, since w_1, w_2 , form a fundamental system,

$$\lambda(c_{11} - \rho) + \mu c_{21} = 0, \quad \lambda c_{12} + \mu(c_{22} - \rho) = 0; \quad (1)$$

so that
$$\begin{vmatrix} c_{11} - \rho & c_{21} \\ c_{12} & c_{22} - \rho \end{vmatrix} = 0.$$

This is known as the *Fundamental Equation belonging to the singularity* ζ . If a root of this equation is substituted for ρ in equations (1), values of λ and μ are obtained such that $\bar{W} = \rho W$.

Neither of the ρ 's can be zero, since $D \neq 0$. If $\rho = 1$, the corresponding integral W will be uniform in the vicinity of ζ .

THEOREM. The fundamental equation is independent of the original fundamental system selected.

Let W_1, W_2 , be any other fundamental system, and let

$$\bar{W}_1 = b_{11}W_1 + b_{12}W_2, \quad \bar{W}_2 = b_{21}W_1 + b_{22}W_2,$$

so that the new fundamental equation is

$$\begin{vmatrix} b_{11} - \rho & b_{21} \\ b_{12} & b_{22} - \rho \end{vmatrix} = 0.$$

$$\text{Now, if } \left. \begin{array}{l} W_1 = a_{11}w_1 + a_{12}w_2, \quad W_2 = a_{21}w_1 + a_{22}w_2, \\ \bar{W}_1 = a_{11}\bar{w}_1 + a_{12}\bar{w}_2, \quad \bar{W}_2 = a_{21}\bar{w}_1 + a_{22}\bar{w}_2. \end{array} \right\} \quad (2)$$

$$\text{Hence } b_{11}(a_{11}w_1 + a_{12}w_2) + b_{12}(a_{21}w_1 + a_{22}w_2) \\ = a_{11}(c_{11}w_1 + c_{12}w_2) + a_{12}(c_{21}w_1 + c_{22}w_2).$$

$$\text{Accordingly } \begin{array}{l} b_{11}a_{11} + b_{12}a_{21} = a_{11}c_{11} + a_{12}c_{21}, \\ b_{11}a_{12} + b_{12}a_{22} = a_{11}c_{12} + a_{12}c_{22}. \end{array}$$

$$\text{Similarly } \begin{array}{l} b_{21}a_{11} + b_{22}a_{21} = a_{21}c_{11} + a_{22}c_{21}, \\ b_{21}a_{12} + b_{22}a_{22} = a_{21}c_{12} + a_{22}c_{22}. \end{array}$$

Therefore

$$\begin{aligned} & \begin{vmatrix} a_{11} & a_{12} \\ a_{21} & a_{22} \end{vmatrix} \begin{vmatrix} c_{11} - \rho & c_{21} \\ c_{12} & c_{22} - \rho \end{vmatrix} \\ &= \begin{vmatrix} a_{11}(c_{11} - \rho) + a_{12}c_{21} & a_{11}c_{12} + a_{12}(c_{22} - \rho) \\ a_{21}(c_{11} - \rho) + a_{22}c_{21} & a_{21}c_{12} + a_{22}(c_{22} - \rho) \end{vmatrix} \\ &= \begin{vmatrix} (b_{11} - \rho)a_{11} + b_{12}a_{21} & (b_{11} - \rho)a_{12} + b_{12}a_{22} \\ b_{21}a_{11} + (b_{22} - \rho)a_{21} & b_{21}a_{12} + (b_{22} - \rho)a_{22} \end{vmatrix} \\ &= \begin{vmatrix} b_{11} - \rho & b_{12} \\ b_{21} & b_{22} - \rho \end{vmatrix} \begin{vmatrix} a_{11} & a_{12} \\ a_{21} & a_{22} \end{vmatrix}. \end{aligned}$$

$$\text{Hence } \begin{vmatrix} b_{11} - \rho & b_{21} \\ b_{12} & b_{22} - \rho \end{vmatrix} = \begin{vmatrix} c_{11} - \rho & c_{21} \\ c_{12} & c_{22} - \rho \end{vmatrix}.$$

Fundamental System associated with the Fundamental Equation.

There are two cases to consider: (I.) when the roots of the fundamental equation are distinct, and (II.) when they are equal.

I. Let the roots ρ_1, ρ_2 , be distinct; then there are two integrals W_1, W_2 , such that

$$\bar{W}_1 = \rho_1 W_1, \quad \bar{W}_2 = \rho_2 W_2.$$

Now let
$$r_1 = \frac{1}{2\pi i} \text{Log } \rho_1, \quad r_2 = \frac{1}{2\pi i} \text{Log } \rho_2.$$

Then, if
$$\theta_1 = (z - \zeta)^{r_1}, \quad \theta_2 = (z - \zeta)^{r_2},$$

$$\bar{\theta}_1 = \rho_1 \theta_1, \quad \bar{\theta}_2 = \rho_2 \theta_2;$$

so that W_1/θ_1 and W_2/θ_2 are uniform functions in the vicinity of ζ .

Accordingly $W_1 = (z - \zeta)^{r_1} \psi_1(z)$, $W_2 = (z - \zeta)^{r_2} \psi_2(z)$, where $\psi_1(z)$ and $\psi_2(z)$ are uniform in the vicinity of ζ .

The integrals W_1 and W_2 are linearly independent. For, if not, an equation $c_1 W_1 + c_2 W_2 = 0$, and consequently an equation $c_1 \rho_1 W_1 + c_2 \rho_2 W_2 = 0$ would exist. But these equations can only exist simultaneously if $\rho_1 = \rho_2$, which contradicts our hypothesis.

II. Let the roots be equal; then $(c_{11} - c_{22})^2 + 4c_{12}c_{21} = 0$.

We distinguish between the cases: (i) when c_{12} and c_{21} are both zero; and (ii) when they are not both zero.

(i) In the first case $\rho = c_{11} = c_{22}$, and $\bar{w}_1 = \rho w_1$, $\bar{w}_2 = \rho w_2$. From equations (2) it follows that, no matter what system is originally selected, these equations hold. Accordingly

$$w_1 = (z - \zeta)^r \psi_1(z), \quad w_2 = (z - \zeta)^r \psi_2(z),$$

where $\psi_1(z), \psi_2(z)$, are uniform in the vicinity of ζ , and

$$r = \frac{1}{2\pi i} \text{Log } \rho.$$

(ii) In the second case, let W be the integral found to satisfy the condition $\bar{W} = \rho W$, and let w be any linearly independent integral. Then $\bar{w} = c_1 W + c_2 w$, and the fundamental equation becomes

$$\begin{vmatrix} \rho - \sigma & 0 \\ c_1 & c_2 - \sigma \end{vmatrix} = 0,$$

where σ is the quantity to be determined.

Accordingly, since the roots are equal, $c_2 = \rho$; therefore

$$\bar{w} = c_1 W + \rho w.$$

Now replace W by W_1 , where $\rho W_1 = c_1 W$, and write W_2 for w . Then W_1, W_2 , form a fundamental system such that

$$\bar{W}_1 = \rho W_1, \quad \bar{W}_2 = \rho(W_1 + W_2).$$

Hence

$$W_1 = (z - \xi)^r \psi_1(z),$$

where $\psi_1(z)$ is uniform near ξ .

Again,

$$\frac{\overline{W}_2}{\overline{W}_1} = \frac{W_2}{W_1} + 1;$$

but, if $\theta = \frac{1}{2\pi i} \log(z - \xi)$, $\bar{\theta} = \theta + 1$. Therefore

$$\frac{\overline{W}_2}{\overline{W}_1} - \bar{\theta} = \frac{W_2}{W_1} - \theta;$$

so that

$$\frac{W_2}{W_1} - \frac{1}{2\pi i} \log(z - \xi)$$

is uniform near ξ . Consequently

$$W_2 = (z - \xi)^r \left\{ \psi_2(z) + \frac{1}{2\pi i} \log(z - \xi) \cdot \psi_1(z) \right\},$$

where $\psi_2(z)$ is uniform near ξ .

87. Regular Integrals. If the highest negative powers of $(z - \xi)$ in the Laurent Expansions for $\psi_1(z)$ and $\psi_2(z)$ are finite, the integrals W_1 and W_2 are called *Regular Integrals*. Now the quantities $r = \frac{1}{2\pi i} \text{Log } \rho$ are not definite, but have values differing by integers. Hence, if the integrals are regular, the values of r_1 and r_2 can be chosen so that

$$\psi_1(z) = \sum_0^{\infty} a_n (z - \xi)^n, \quad \psi_2(z) = \sum_0^{\infty} b_n (z - \xi)^n,$$

where a_0 and b_0 are non-zero. If a is the nearest singularity to ξ , these expansions are valid for $|z - \xi| < |a - \xi|$. Thus

$$\left. \begin{aligned} W_1 &= (z - \xi)^{r_1} \psi_1(z), \\ W_2 &= (z - \xi)^{r_2} \psi_2(z) + (z - \xi)^{r_1} \psi_1(z) \frac{1}{2\pi i} \log(z - \xi), \end{aligned} \right\} \quad (\text{A})$$

where $r_1 - r_2$ is an integer or zero.

For the first integral r_1 , and for the second integral the greater of the two quantities r_1 and r_2 , is called *the Index at the point ξ* .

It is only possible to carry out the theory completely when the integrals are regular; and we shall therefore, in what follows, confine our attention to equations whose integrals are regular.

Condition that the Integrals at a Singularity should be Regular. If w_1 is an integral of equation (A) of § 83, a linearly independent integral can be found as follows.

Let $w_2 = w_1 \int v dz$ be substituted in the equation; then

$$w_1 \frac{dv}{dz} + \left\{ 2 \frac{dw_1}{dz} - p(z)w_1 \right\} v = 0;$$

so that
$$v = A e^{\int \left\{ 2 \frac{w_1'}{w_1} - p(z) \right\} dz} = A w_1^2 e^{-\int p(z) dz}.$$

The integrals w_1 and w_2 are linearly independent. For, if not, $c_1 w_1 + c_2 w_2 = 0$, and therefore

$$c_1 + c_2 \int v dz = 0.$$

Hence, differentiating, we have $c_2 v = 0$. But v is not identically zero; therefore $c_2 = 0$, and consequently $c_1 = 0$.

Thus w_1, w_2 , form a fundamental system. Also

$$\Delta(z) = \begin{vmatrix} w_1' & w_1 \\ w_1 v & 0 \end{vmatrix} = -w_1^2 v.$$

Since every other integral can be expressed linearly in terms of w_1 and w_2 , it is only necessary to find the condition that w_1 and w_2 should be regular.

Now we can always choose w_1 so that v is free from logarithms. For, if w_1 is free from logarithms, while w_2 contains them,

$$\bar{w}_1 = \rho w_1, \quad \bar{w}_2 = c w_1 + \rho w_2.$$

Thus

$$\frac{\bar{w}_2}{w_1} = \frac{c}{\rho} + \frac{w_2}{w_1};$$

and therefore

$$\bar{v} = \frac{d}{dz} \left(\frac{\bar{w}_2}{w_1} \right) = \frac{d}{dz} \left(\frac{w_2}{w_1} \right) = v.$$

Hence v is uniform in the vicinity of ξ . Consequently $\Delta(z)$ or $-w_1^2 v$ is also free from logarithms.

Again, if w_1 is replaced by W_1 , where $c w_1 = \rho W_1$, then $\bar{W}_1 = \rho W_1$, $\bar{w}_2 = \rho(W_1 + w_2)$, and

$$V = \frac{d}{dz} \left(\frac{w_2}{W_1} \right) = \frac{\rho}{c} v,$$

so that V is free from logarithms.

Now write w_1 and v for W_1 and V ; then

$$\bar{w}_1 = \rho w_1, \quad \bar{w}_2 = \rho(w_1 + w_2).$$

Thus w_1 and w_2 can be chosen so as to have the forms of formulae (A).

In order to determine the index of $\Delta(z)$, three cases have to be considered.

I. Let w_1 and w_2 be free from logarithms, and let $r_1 \neq r_2$. Then the index of $\Delta(z)$ or $-w_1^2 v$ is $2r_1 + (r_2 - r_1 - 1) = r_1 + r_2 - 1$, since $v = \frac{d}{dz}(w_2/w_1)$.

II. Let w_1 and w_2 be free from logarithms, and let $r_1 = r_2$. Then, by subtracting a multiple of w_1 from w_2 , we can remove the first term of w_2 , and thus get Case I.

III. Let w_2 involve a logarithm. If $r_2 = r_1$, then

$$v = \frac{1}{2\pi i(z-\xi)} + \phi(z),$$

where $\phi(z)$ is holomorphic near ξ . Hence the index of $\Delta(z)$ is $2r_1 - 1 = r_1 + r_2 - 1$. If $r_2 < r_1$, the index of v is $r_2 - r_1 - 1$, so that the index of $\Delta(z)$ is $r_1 + r_2 - 1$. If $r_2 > r_1$, then, adding w_1 to w_2 , we get the case $r_1 = r_2$.

Hence in every case the index of $\Delta(z)$ is $r_1 + r_2 - 1$.

Now $p(z) = \Delta_1(z)/\Delta(z)$, $q(z) = -\Delta_2(z)/\Delta(z)$ (Theorem IV. § 85). But a circuit about ξ multiplies $\Delta(z)$, $\Delta_1(z)$, $\Delta_2(z)$, by the same constant D (§ 86); hence $p(z)$ and $q(z)$ are uniform in the neighbourhood of ξ .

Again, since $\Delta(z)$ has the index $r_1 + r_2 - 1$, $\Delta_1(z)$ or $\frac{d}{dz}\Delta(z)$ must have an index $\geq r_1 + r_2 - 2$, and $\Delta_2(z)$ or $w_1 w_1'' v - 2w_1'^2 v - w_1 w_1' v'$ an index $\geq r_1 + r_2 - 3$.

Accordingly, in order that the integrals should be regular in the vicinity of the singular point ξ , it is necessary that the equation should be of the form

$$\frac{d^2 w}{dz^2} = \frac{P(z)}{(z-\xi)} \frac{dw}{dz} + \frac{Q(z)}{(z-\xi)^2} w,$$

where $P(z)$ and $Q(z)$ are holomorphic for $|z-\xi| < |a-\xi|$. In the following section we shall prove that these conditions are sufficient.

COROLLARY. If the integrals at infinity are regular, $p(z)$ and $q(z)$ must have zeros at infinity of the first and second orders respectively. The proof is left as an exercise to the reader.

88. The Method of Frobenius. If $P(z)$ and $Q(z)$ are holomorphic for $|z - \xi| < |a - \xi|$, a fundamental system of integrals can be found for the equation

$$\frac{d^2 w}{dz^2} = \frac{P(z) dw}{z - \xi} + \frac{Q(z)}{(z - \xi)^2} w, \tag{1}$$

such that both integrals are regular in the neighbourhood of ξ .

If the origin is transferred to ξ , equation (1) becomes

$$z^2 w'' = z\phi(z)w' + \psi(z)w, \tag{2}$$

where $\phi(z)$ and $\psi(z)$ are holomorphic in the neighbourhood of the origin.

Let $w = z^\rho \sum_0^\infty c_n z^n$; then, if $\phi(z) = \sum_0^\infty a_n z^n$ and $\psi(z) = \sum_0^\infty b_n z^n$,

$$\begin{aligned} z^2 w'' - z\phi(z)w' - \psi(z)w &= \sum_{n=0}^\infty c_n z^{\rho+n} \{(\rho+n)(\rho+n-1) - \phi(z)(\rho+n) - \psi(z)\} \\ &= \sum_{n=0}^\infty d_n z^{\rho+n}, \end{aligned}$$

where $d_0 = c_0 \{\rho(\rho-1) - a_0\rho - b_0\}$,

and $d_n = c_n \{(\rho+n)(\rho+n-1) - a_0(\rho+n) - b_0\} - c_{n-1} \{a_1(\rho+n-1) + b_1\} - c_{n-2} \{a_2(\rho+n-2) + b_2\} - \dots - c_0(a_n\rho + b_n)$,
($n = 1, 2, 3, \dots$).

Hence, if all the quantities $d_0, d_1, d_2, d_3, \dots$, vanish, and if $\sum_0^\infty c_n z^n$ is convergent, w is a solution of (2).

The Indicial Equation. The equation in ρ ,

$$\rho(\rho-1) - a_0\rho - b_0 = 0,$$

is called the *Indicial Equation*. From it can be obtained, in general, two values of ρ . If one of these values is substituted for ρ in the equations $d_1=0, d_2=0, d_3=0, \dots$, values for c_1, c_2, c_3, \dots , are found in the form

$$c_n = c_0 \frac{H_n(\rho)}{\{(\rho+n)(\rho+n-1) - a_0(\rho+n) - b_0\} \{(\rho+n-1)(\rho+n-2) - a_0(\rho+n-1) - b_0\} \dots \{(\rho+1)\rho - a_0(\rho+1) - b_0\}}, \tag{3}$$

where $H_n(\rho)$ is a polynomial in ρ .

If the roots of the indicial equation do not differ by an integer, none of the coefficients c_1, c_2, c_3, \dots , is infinite. If the roots are

ρ_1 and $\rho_1 + n$, where m is a positive integer, then when $\rho = \rho_1$, $c_m, c_{m+1}, c_{m+2}, \dots$, are usually infinite. To avoid this we put $c_0 = c(\rho - \rho_1)$, which makes c_0, c_1, \dots, c_{m-1} , all zero, and $c_m, c_{m+1}, c_{m+2}, \dots$, finite, when $\rho = \rho_1$.

Now assume $d_1 = d_2 = d_3 = \dots = 0$; then

$$z^2 w'' - z\phi(z)w' - \psi(z)w = z^\rho c_0 \{\rho(\rho-1) - a_0\rho - b_0\}, \quad (4)$$

$$c_{n-1}\{a_1(\rho+n-1) + b_1\} + c_{n-2}\{a_2(\rho+n-2) + b_2\} \\ + \dots + c_0(a_n\rho + b_n)$$

$$\text{where } c_n = \frac{\quad}{(\rho+n)(\rho+n-1) - a_0(\rho+n) - b_0}, \quad (5)$$

for $n = 1, 2, 3, \dots$

Let $\phi(z)$ and $\psi(z)$ be holomorphic within and on the circle $|z| = R$. Then, if M_1 and M_2 are the maximum values of $\phi(z)$ and $\psi(z)$ on this circle,

$$|a_n| \leq M_1/R^n, \quad |b_n| \leq M_2/R^n.$$

$$\text{Thus } |a_n(\rho+n) + b_n| \leq \{M_1|\rho+n| + M_2\}/R^n;$$

so that, if

$$\gamma_n = \left\{ |c_{n-1}| \frac{M_1|\rho+n-1| + M_2}{R} + \dots + |c_0| \frac{M_1|\rho| + M_2}{R^n} \right\} \\ \times \frac{1}{|(\rho+n)(\rho+n-1) - a_0(\rho+n) - b_0|},$$

then

$$|c_n| \leq \gamma_n.$$

$$\text{Now } \gamma_{n+1} |(\rho+n+1)(\rho+n) - a_0(\rho+n+1) - b_0| \\ - \frac{\gamma_n}{R} |(\rho+n)(\rho+n-1) - a_0(\rho+n) - b_0| \\ = |c_n| \frac{M_1|\rho+n| + M_2}{R} \\ \leq \gamma_n \frac{M_1|\rho+n| + M_2}{R}.$$

Hence

$$\frac{\gamma_{n+1}}{\gamma_n} \leq \frac{|(\rho+n)(\rho+n-1) - a_0(\rho+n) - b_0| + M_1|\rho+n| + M_2}{|(\rho+n+1)(\rho+n) - a_0(\rho+n+1) - b_0| R}.$$

Accordingly, if ρ is finite, and has not any of the values $\rho_1 - 1, \rho_1 - 2, \dots, \rho_2 - 1, \rho_2 - 2, \dots$, where ρ_1, ρ_2 , are the roots of the indicial equation,

$$\lim_{n \rightarrow \infty} \frac{\gamma_{n+1}}{\gamma_n} \leq \frac{1}{R}.$$

Thus $\sum_0^\infty \gamma_n z^n$, and consequently $\sum_0^\infty c_n z^n$, converges if $|z| < R$.

But if α is the nearest singularity to the origin, R can always be chosen so as to include any point z , such that $|z| < |\alpha|$, within the circle. Thus the series $\sum_0^\infty c_n z^n$ is convergent for $|z| < |\alpha|$, and $w = z^\rho \sum_0^\infty c_n z^n$ satisfies equation (4), if c_1, c_2, c_3, \dots , are given by equations (5).

Uniform Convergence of the Series with regard to ρ . Consider a region K in the ρ -plane bounded by the large circle $|\rho| = \sigma$ and small circles whose centres are those of the points $\rho_1 - 1, \rho_1 - 2, \dots, \rho_2 - 1, \rho_2 - 2, \dots$, which are interior to this large circle. Then, if $n \geq \nu > \sigma$, for all points of K ,

$$\begin{aligned} & |(\rho + n)(\rho + n - 1) - a_0(\rho + n) - b_0| \\ & \geq |\rho + n|^2 - (a_0 + 1)(\rho + n) + b_0| \\ & \geq (n - \sigma)^2 - \{(M_1 + 1)(\sigma + n) + M_2\}. \end{aligned}$$

Now let ν be taken so great that the last expression is always positive. Also let M denote the maximum value of

$$|c_{\nu-1}| \frac{M_1 |\rho + \nu - 1| + M_2}{R} + \dots + |c_0| \frac{M_1 |\rho| + M_2}{R^\nu}$$

for the region K . Then, if

$$C_n = \frac{C_{n-1} \frac{M_1(\sigma + n - 1) + M_2}{R} + \dots + C_\nu \frac{M_1(\sigma + \nu) + M_2}{R^{n-\nu}} + \frac{M}{R^{n-\nu}}}{(n - \sigma)^2 - \{(M_1 + 1)(\sigma + n) + M_2\}}$$

we have $\gamma_n \leq C_n, (n = \nu, \nu + 1, \nu + 2, \dots)$.

As in the case of the γ 's, we can obtain

$$\lim_{n \rightarrow \infty} \frac{C_{n+1}}{C_n} = \frac{1}{R};$$

so that $\sum_{n=\nu}^\infty C_n R'^n$ is convergent if $R' < R$. Thus the series $\sum_0^\infty c_n z^n$ is uniformly convergent if $|z| \leq R'$ and if ρ lies in K . It is therefore holomorphic with regard to both z and ρ , provided that $|z| < |\alpha|$, and that ρ has any finite values except $\rho_1 - 1, \rho_1 - 2, \dots, \rho_2 - 1, \rho_2 - 2, \dots$. If, however, $\rho_2 = \rho_1 + m$ and if $c_0 = c(\rho - \rho_1)$, the point $\rho_2 - m$ is not excluded.

The Fundamental System associated with the Roots of the Indicial Equation. There are three cases to consider.

I. Let ρ_1 and ρ_2 differ by a quantity which is not an integer.

Then, if ρ is equated in turn to ρ_1 and ρ_2 , equation (4) becomes equation (2), and we obtain two independent solutions,

$$w_1 = z^{\rho_1} \sum_{n=0}^{\infty} c_n^{(1)} z^n, \quad w_2 = z^{\rho_2} \sum_{n=0}^{\infty} c_n^{(2)} z^n.$$

II. Let the indicial equation have two equal roots $\rho = \rho_1$; then equation (4) becomes

$$z^2 w'' - 2z\phi(z)w' - \psi(z)w = z^\rho c_0(\rho - \rho_1)^2.$$

If this equation is differentiated with regard to ρ , it becomes

$$\begin{aligned} z^2 \frac{d^2}{dz^2} \left(\frac{\partial w}{\partial \rho} \right) - 2z\phi(z) \frac{d}{dz} \left(\frac{\partial w}{\partial \rho} \right) - \psi(z) \frac{\partial w}{\partial \rho} \\ = z^\rho c_0(\rho - \rho_1) \{ 2 + (\rho - \rho_1) \log z \}. \end{aligned}$$

If in these two equations ρ_1 is substituted for ρ , it follows that w and $\frac{\partial w}{\partial \rho}$ both satisfy equation (2). Thus a fundamental system w_1, w_2 , is obtained for equation (2), where

$$w_1 = z^{\rho_1} \sum_0^{\infty} c_n z^n, \quad w_2 = \left(\frac{\partial w}{\partial \rho} \right)_{\rho=\rho_1} = w_1 \log z + z^{\rho_1} \sum_0^{\infty} \left(\frac{\partial c_n}{\partial \rho} \right)_{\rho=\rho_1} z^n.$$

III. Let $\rho_2 = \rho_1 + m$, where m is a positive integer. Then, if c_0 is replaced by $c(\rho - \rho_1)$, equation (4) becomes

$$z^2 w'' - z\phi(z)w' - \psi(z)w = z^\rho c(\rho - \rho_1)^2 (\rho - \rho_2).$$

Thus equation (2) is satisfied by the fundamental system

$$\begin{aligned} w_1 &= z^{\rho_1} \sum_m^{\infty} c_n z^n = z^{\rho_2} \sum_m^{\infty} c_n z^{n-m}, \\ w_2 &= \left(\frac{\partial w}{\partial \rho} \right)_{\rho=\rho_1} = w_1 \log z + z^{\rho_1} \sum_0^{\infty} \left(\frac{\partial c_n}{\partial \rho} \right)_{\rho=\rho_1} z^n. \end{aligned}$$

Solutions free from Logarithms. If $H_m(\rho)$ contains $\rho - \rho_1$ as a factor, c_0 can be left unaltered, and both solutions will be free from logarithms. In that case w_1 will be of the form $z^{\rho_1} P(z)$, where $P(z)$ is a polynomial of degree $\leq (m-1)$.

89. The Gaussian Differential Equation. The equation

$$z(1-z)w'' + \{\gamma - (\alpha + \beta + 1)z\}w' - \alpha\beta w = 0$$

is known as *Gauss's Equation*, or the *Hypergeometric Equation*: it has singularities at 0, 1, ∞ .

In the vicinity of $z=0$ let $w = \sum_0^\infty c_n z^{\rho+n}$; then

$$(1-z) \sum_0^\infty c_n (\rho+n)(\rho+n-1) z^{\rho+n-1} + \{\gamma - (\alpha + \beta + 1)z\} \sum_0^\infty c_n (\rho+n) z^{\rho+n-1} - \alpha\beta \sum_0^\infty c_n z^{\rho+n} = 0.$$

Thus the indicial equation is

$$\rho(\rho-1) + \gamma\rho = \rho(\rho-1 + \gamma) = 0.$$

Also, for $n=0, 1, 2, 3, \dots$,

$$c_{n+1}(\rho+n+1)(\rho+n) - c_n(\rho+n)(\rho+n-1) + \gamma c_{n+1}(\rho+n+1) - (\alpha + \beta + 1)(\rho+n)c_n - \alpha\beta c_n = 0;$$

so that

$$c_{n+1}(\rho+n+1)(\rho+n+\gamma) = c_n(\rho+n+\alpha)(\rho+n+\beta).$$

There are four cases to consider.

I. Let $1-\gamma$ be not an integer. Then, assigning to ρ the values 0 and $1-\gamma$ in turn, we obtain the fundamental system,

$$w_1 = F(\alpha, \beta, \gamma, z), \quad w_2 = z^{1-\gamma} F(\alpha - \gamma + 1, \beta - \gamma + 1, 2 - \gamma, z).$$

II. Let $1-\gamma=0$. Then the indicial equation has two equal roots $\rho=0$. Hence one solution is $w_1 = c_0 F(\alpha, \beta, \gamma, z)$.

Again,

$$c_n = \frac{(\rho + \alpha + n - 1)(\rho + \alpha + n - 2) \dots (\rho + \alpha) \times (\rho + \beta + n - 1)(\rho + \beta + n - 2) \dots (\rho + \beta)}{(\rho + n)(\rho + n - 1) \dots (\rho + 1)(\rho + n)(\rho + n - 1) \dots (\rho + 1)} c_0;$$

so that

$$\frac{\partial c_n}{\partial \rho} = c_n \sum_{r=0}^{n-1} \left\{ \frac{1}{\rho + \alpha + r} + \frac{1}{\rho + \beta + r} - \frac{2}{\rho + r + 1} \right\}, \quad (n=1, 2, 3, \dots).$$

Thus the second solution is

$$w_2 = c_0 \left\{ F(\alpha, \beta, \gamma, z) \log z + \sum_1^\infty k_n z^n \right\},$$

where

$$k_n = \frac{\alpha(\alpha+1) \dots (\alpha+n-1)\beta(\beta+1) \dots (\beta+n-1)}{(n!)^2} \times \left\{ \sum_{r=0}^{n-1} \left(\frac{1}{\alpha+r} + \frac{1}{\beta+r} \right) - \sum_1^n \frac{2}{r} \right\}.$$

III. Let $1-\gamma = -m$, where m is a positive integer. One solution is $w_1 = c_0 F(\alpha, \beta, \gamma, z)$. Again, putting $c_0 = c(\rho+m)$,

we have

$$c_n = \frac{(\rho + \alpha + n - 1)(\rho + \alpha + n - 2) \dots (\rho + \alpha)(\rho + \beta + n - 1) \times (\rho + \beta + n - 2) \dots (\rho + \beta)}{(\rho + n)(\rho + n - 1) \dots (\rho + 1)(\rho + m + n) \times (\rho + m + n - 1) \dots (\rho + m + 1)} (\rho + m)c.$$

Hence the second solution is

$$\begin{aligned} w_2 = & (-1)^{m-1} \frac{(\alpha - m)(\alpha - m + 1) \dots (\alpha - 1) \times (\beta - m)(\beta - m + 1) \dots (\beta - 1)}{(m-1)!m!} cF(\alpha, \beta, \gamma, z) \log z \\ & + cz^{-m} \sum_{n=0}^{m-1} (-1)^n \frac{(\alpha - m)(\alpha - m + 1) \dots (\alpha - m + n - 1) \times (\beta - m)(\beta - m + 1) \dots (\beta - m + n - 1)}{n!(m-n)(m-n+1) \dots (m-1)} z^n \\ & + (-1)^{m-1} c \frac{(\alpha - m)(\alpha - m + 1) \dots (\alpha - 1)(\beta - m) \times (\beta - m + 1) \dots (\beta - 1)}{(m-1)!m!} \\ & \times \sum_{n=0}^{\infty} \frac{\alpha(\alpha+1) \dots (\alpha+n-1)\beta(\beta+1) \dots (\beta+n-1)}{n! \gamma(\gamma+1) \dots (\gamma+n-1)} \\ & \times \left\{ \sum_{r=0}^{m+n-1} \left(\frac{1}{\alpha - m + r} + \frac{1}{\beta - m + r} - \frac{1}{1+r} \right) + \sum_{r=1}^{m-1} \frac{1}{r} - \sum_{r=1}^n \frac{1}{r} \right\} z^n. \end{aligned}$$

If either α or β is one of the numbers $1, 2, 3, \dots, m$, the terms involving $\log z$ disappear, and the second integral becomes

$$cz^{1-\gamma} F(\alpha - \gamma + 1, \beta - \gamma + 1, 2 - \gamma, z),$$

in which the hypergeometric factor is a polynomial. Since $\rho + m$ is a factor of $H_m(\rho)$, this integral could also be obtained by putting $\rho = 1 - \gamma$ in $\sum_0^{\infty} c_n z^{\rho+n}$.

Let neither α nor β have any of the values $1, 2, 3, \dots, m$; then, if w_2 is divided by the coefficient of $\log z$, and a multiple of w_1 subtracted from it, the fundamental system can be taken to be

$$w_1 = F(\alpha, \beta, \gamma, z), \quad w_2 = w_1 \log z + F_1(\alpha, \beta, \gamma, z),$$

where

$$\begin{aligned} & F_1(\alpha, \beta, \gamma, z) \\ = & (-1)^{\gamma} z^{1-\gamma} \sum_{n=0}^{\gamma-2} (-1)^n \frac{(\gamma-1)!(\gamma-n-2)!}{n!(\alpha-1)(\alpha-2) \dots (\alpha-\gamma+n+1)(\beta-1) \times (\beta-2) \dots (\beta-\gamma+n+1)} \\ & + \sum_{n=0}^{\infty} \frac{\alpha(\alpha+1) \dots (\alpha+n-1)\beta(\beta+1) \dots (\beta+n-1)}{n! \gamma(\gamma+1) \dots (\gamma+n-1)} \\ & \times \left\{ \sum_{r=0}^{n-1} \frac{1}{\alpha+r} + \sum_{r=0}^{n-1} \frac{1}{\beta+r} - \sum_{r=1}^n \frac{1}{r} - \sum_{r=0}^{n-1} \frac{1}{\gamma+r} \right\} z^n. \end{aligned}$$

IV. Let $1-\gamma$ be a positive integer. This case can be reduced to Case III.; for the substitution $w = z^{1-\gamma}W$ gives

$$z(1-z)W'' + \{\gamma' - (\alpha' + \beta' + 1)z\}W' - \alpha'\beta'W = 0,$$

where $\alpha' = \alpha - \gamma + 1$, $\beta' = \beta - \gamma + 1$, $\gamma' = 2 - \gamma$; so that $1 - \gamma' = \gamma - 1$ is a negative integer.

Thus, if either α or β has any of the values $0, -1, -2, \dots, \gamma$, the two integrals are

$$F(\alpha, \beta, \gamma, z), \quad z^{1-\gamma}F(\alpha - \gamma + 1, \beta - \gamma + 1, 2 - \gamma, z),$$

where vanishing factors in the numerators and denominators of the coefficients of $F(\alpha, \beta, \gamma, z)$ are cancelled; while if neither α nor β has any of these values, the fundamental system can be taken to be

$$w_1 = z^{1-\gamma}F(\alpha - \gamma + 1, \beta - \gamma + 1, 2 - \gamma, z), \\ w_2 = w_1 \log z + z^{1-\gamma}F_1(\alpha - \gamma + 1, \beta - \gamma + 1, 2 - \gamma, z).$$

Solutions Regular near $z=1$. The substitution $z = 1 - \xi$ gives

$$\xi(1-\xi) \frac{d^2w}{d\xi^2} + \{(a + \beta + 1 - \gamma) - (a + \beta + 1)\xi\} \frac{dw}{d\xi} - a\beta w = 0.$$

Hence solutions regular near $z=1$ are obtained by replacing α, β, γ, z by $\alpha, \beta, \alpha + \beta + 1 - \gamma, 1 - z$, respectively in the integrals already obtained.

For example, when $\gamma - \alpha - \beta$ is not an integer, the solutions are

$$F(\alpha, \beta, \alpha + \beta + 1 - \gamma, 1 - z), \\ (1 - z)^{\gamma - \alpha - \beta} F(\gamma - \beta, \gamma - \alpha, \gamma - \alpha - \beta + 1, 1 - z).$$

Solutions Regular at Infinity. If we put $z = 1/\xi$, $w = \xi^\alpha W$, then

$$\xi(1-\xi) \frac{d^2W}{d\xi^2} + \{(1 + \alpha - \beta) - (2\alpha + 2 - \gamma)\xi\} \frac{dW}{d\xi} \\ - \alpha(\alpha + 1 - \gamma)W = 0.$$

Hence solutions regular at infinity are obtained from the solutions regular near $z=0$ by replacing α, β, γ, z , by $\alpha, 1 + \alpha - \gamma, 1 + \alpha - \beta, 1/z$, and multiplying by $z^{-\alpha}$. When $\alpha - \beta$ is not an integer, the two solutions are

$$w_1 = z^{-\alpha}F(\alpha, 1 + \alpha - \gamma, 1 + \alpha - \beta, 1/z), \\ w_2 = z^{-\beta}F(\beta, 1 + \beta - \gamma, 1 + \beta - \alpha, 1/z).$$

The Differential Equation of the Quarter Periods of the Jacobian Elliptic Functions. If $\alpha = \beta = 1/2$, $\gamma = 1$, Gauss's Equation becomes

$$z(1-z)w'' + (1-2z)w' - \frac{1}{4}w = 0. \quad (\S 70, \text{Cor.})$$

It is left as an exercise to the reader to prove that solutions regular near 0, 1, ∞ , are:

$$F\left(\frac{1}{2}, \frac{1}{2}, 1, z\right), \quad F\left(\frac{1}{2}, \frac{1}{2}, 1, z\right) \log z + 4 \sum_{n=1}^{\infty} \frac{(2n!)^2}{2^{4n}(n!)^4} \left(\sum_{n+1}^{2n} \frac{1}{r}\right) z^n;$$

$$F\left(\frac{1}{2}, \frac{1}{2}, 1, 1-z\right), \quad F\left(\frac{1}{2}, \frac{1}{2}, 1, 1-z\right) \log(1-z) \\ + 4 \sum_{n=1}^{\infty} \frac{(2n!)^2}{2^{4n}(n!)^4} \left(\sum_{n+1}^{2n} \frac{1}{r}\right) (1-z)^n;$$

$$z^{-\frac{1}{2}} F\left(\frac{1}{2}, \frac{1}{2}, 1, \frac{1}{z}\right), \quad z^{-\frac{1}{2}} F\left(\frac{1}{2}, \frac{1}{2}, 1, \frac{1}{z}\right) \log \frac{1}{z} \\ + 4z^{-\frac{1}{2}} \sum_{n=1}^{\infty} \frac{(2n!)^2}{2^{4n}(n!)^4} \left(\sum_{n+1}^{2n} \frac{1}{r}\right) \frac{1}{z^n}.$$

For other worked examples on differential equations, see Chapter XIV. §§ 90, 91.

EXAMPLES XIII.

Find regular integrals in the domain of $z=0$ for equations 1-16:

1. $2z^2w'' + zw' - (1+z^2)w = 0.$

$$\text{Ans. } w_1 = z + \frac{z^3}{2 \cdot 7} + \frac{z^5}{2 \cdot 4 \cdot 7 \cdot 11} + \frac{z^7}{2 \cdot 4 \cdot 6 \cdot 7 \cdot 11 \cdot 15} + \dots,$$

$$w_2 = z^{-1/2} \left(1 + \frac{z^2}{2 \cdot 1} + \frac{z^4}{2 \cdot 4 \cdot 1 \cdot 5} + \frac{z^6}{2 \cdot 4 \cdot 6 \cdot 1 \cdot 5 \cdot 9} + \dots \right).$$

2. $z(1-z)w'' + (2-3z)w' - w = 0.$

$$\text{Ans. } w_1 = \frac{1}{z}, \quad w_2 = \frac{1}{z} \log \left(\frac{1}{1-z} \right).$$

3. $z(1-z)w'' - (1+z)w' + w = 0.$

$$\text{Ans. } w_1 = 1/(1-z), \quad w_2 = 1+z.$$

4. $zw'' + w' - w = 0.$

$$\text{Ans. } w_1 = \sum_0^{\infty} \frac{z^n}{(n!)^2},$$

$$w_2 = w_1 \log z - 2 \sum_1^{\infty} \frac{z^n}{(n!)^2} \left(1 + \frac{1}{2} + \dots + \frac{1}{n} \right).$$

5. $z(1+z)w'' - 2w = 0.$

$$\text{Ans. } w_1 = z + z^2, \quad w_2 = w_1 \log \left(\frac{z}{1+z} \right) + \frac{1}{2} + z.$$

6. $zw'' + (z-1)w' + w = 0.$

$$\text{Ans. } w_1 = z^2 e^{-z}, \quad w_2 = w_1 \log z - 1 - z + z^2 - z^2 \sum_2^{\infty} (-1)^n \frac{z^n}{n!} \left(\frac{1}{2} + \frac{1}{3} + \dots + \frac{1}{n} \right).$$

7. $zw'' - w = 0.$ Ans. $w_1 = \sum_0^{\infty} \frac{z^{n+1}}{n!(n+1)!},$

$$w_2 = w_1 \log z + 1 - z - \frac{z^2}{1!2!} \left(\frac{2}{1} + \frac{1}{2} \right) - \frac{z^3}{2!3!} \left(\frac{2}{1} + \frac{2}{2} + \frac{1}{3} \right) - \dots$$

8. $4z^2w'' + 4zw' - (z^2+1)w = 0.$ Ans. $w_1 = z^{-1/2} \sinh(z/2), \quad w_2 = z^{-1/2} \cosh(z/2).$

9. $z^2 w'' + z(1-z)w' - (1+2z)w = 0.$

Ans. $w_1 = ze^z, w_2 = w_1 \log z - \frac{1}{z} + 1 - z \sum_1^{\infty} \frac{z^n}{n!} \left(1 + \frac{1}{2} + \dots + \frac{1}{n}\right).$

10. $zw'' + w' + mzw = 0.$ *Ans.* $w_1 = \sum_0^{\infty} (-1)^n \frac{m^n z^{2n}}{(n!)^2 2^{2n}},$

$w_2 = w_1 \log z - \sum_1^{\infty} (-1)^n \frac{m^n z^{2n}}{(n!)^2 2^{2n}} \left(1 + \frac{1}{2} + \dots + \frac{1}{n}\right).$

11. $z^2 w'' + 4zw' + 2w = 0.$

Ans. $w_1 = 1/z, w_2 = 1/z^2.$

12. $z^2(1-z)w'' + z(1-3z)w' - w = 0.$

Ans. $w_1 = \frac{z}{1-z}, w_2 = \frac{1}{z(1-z)}.$

13. $z^2(1-z)w'' + z(1-z)w' - w = 0.$ *Ans.* $w_1 = (1-z)/z, w_2 = w_1 \log(1-z) + 1.$

14. $z^2(1-z)w'' + z(1-3z)w' - (1+z)w = 0.$

Ans. $w_1 = 1/z, w_2 = w_1 \log(1-z) + 1/(1-z).$

15. $9z^2 w'' - 15zw' + (36z^4 + 7)w = 0.$

Ans. $w_1 = z^{1/3} \cos z^2, w_2 = z^{1/3} \sin z^2.$

16. $z^2 w'' + w = 0.$

Ans. $w_1 = z^{\frac{1+i\sqrt{3}}{2}}, w_2 = z^{\frac{1-i\sqrt{3}}{2}}.$

17. Find regular integrals at infinity for $z^2 w'' + (a+3z)w' + w = 0.$

Ans. $w_1 = \frac{1}{z} e^{a/z}, w_2 = w_1 \log z + \frac{1}{z} \sum_1^{\infty} \frac{a^n z^{-n}}{n!} \left(1 + \frac{1}{2} + \dots + \frac{1}{n}\right).$

18. Find regular integrals at infinity for $z^3 w'' + (2+5z^2)w' + 4zw = 0.$

Ans. $w_1 = \frac{1}{z^2} e^{1/z^2}, w_2 = 2w_1 \log z + \frac{1}{z^2} \sum_1^{\infty} \frac{z^{-2n}}{n!} \left(1 + \frac{1}{2} + \dots + \frac{1}{n}\right).$

CHAPTER XIV.

LEGENDRE'S AND BESSEL'S EQUATIONS: EQUATIONS OF FUCHSIAN TYPE.

90. Legendre Functions. If the substitution $z = 1/\xi$ is made in *Legendre's Equation* (§ 84), it becomes

$$\xi^2(\xi^2 - 1) \frac{d^2 w}{d\xi^2} + 2\xi^3 \frac{dw}{d\xi} + n(n+1)w = 0.$$

Let $w = \sum_0^\infty c_\nu \xi^{\rho+\nu}$; then

$$c_0\{\rho(\rho-1) - n(n+1)\} = 0,$$

$$c_1\{(\rho+1)\rho - n(n+1)\} = 0,$$

$$c_{\nu+2}^{\xi^{\rho+\nu+2}}\{(\rho+\nu+2)(\rho+\nu+1) - n(n+1)\} \\ = c_\nu\{(\rho+\nu)(\rho+\nu-1) + 2(\rho+\nu)\}, \quad (\nu=0, 1, 2, \dots).$$

The indicial equation has roots $\rho_1 = -n$, $\rho_2 = n+1$; and the second equation gives $c_1 = 0$. Also

$$c_{\nu+2}(\rho+\nu+1-n)(\rho+\nu+2+n) = c_\nu(\rho+\nu)(\rho+\nu+1), \\ (\nu=0, 1, 2, \dots).$$

In the first place assume that $\rho_2 - \rho_1$ or $2n+1$ is not an integer; then, if $\rho = -n$,

$$w_1 = c_0 \xi^{-n} \left\{ 1 + \frac{n(n-1)}{2(1-2n)} \xi^2 + \frac{n(n-1)(n-2)(n-3)}{2 \cdot 4(1-2n)(3-2n)} \xi^4 + \dots \right\} \\ = c_0 z^n F\left(-\frac{n}{2}, \frac{1-n}{2}, \frac{1}{2}-n, \frac{1}{z^2}\right);$$

while, if $\rho = n+1$,

$$w_2 = c_0 \xi^{n+1} \left\{ 1 + \frac{(n+1)(n+2)}{2(2n+3)} \xi^2 \right. \\ \left. + \frac{(n+1)(n+2)(n+3)(n+4)}{2 \cdot 4(2n+3)(2n+5)} \xi^4 + \dots \right\} \\ = \frac{c_0}{z^{n+1}} F\left(\frac{n+2}{2}, \frac{n+1}{2}, n+\frac{3}{2}, \frac{1}{z^2}\right).$$

Thus, if

$$Q_n(z) = \frac{\sqrt{\pi}\Pi(n)}{2^{n+1}\Pi(n+1/2)} \frac{1}{z^{n+1}} F\left(\frac{n+2}{2}, \frac{n+1}{2}, n+\frac{3}{2}, \frac{1}{z^2}\right),$$

$$w_2 = c_0 \frac{2^{n+1}\Pi(n+1/2)}{\sqrt{\pi}\Pi(n)} Q_n(z).$$

Again, let $2n+1$ be an integer; then n must either be an integer or half an odd integer.

If n is an integer or zero, all the coefficients are finite. Hence both integrals are free from logarithms. In particular, if n is zero or a positive integer,

$$w_1 = c_0 \frac{2^n(n!)^2}{(2n)!} P_n(z). \tag{§ 54, Cor.}$$

If n is half an odd positive integer, w_2 is the integral which does not involve $\log z$, so that $Q_n(z)$ is an integral. If n is half an odd negative integer, w_1 is the integral not involving $\log z$. But, in this case, since $1/\Gamma(n+3/2)$ is zero when $n+3/2$ is zero or a negative integer, the first $-n-\frac{1}{2}$ terms of $Q_n(z)$ vanish, and therefore

$$Q_n(z) = \frac{\sqrt{\pi}\Gamma(-n)}{\Gamma(\frac{1}{2}-n)} (2z)^n F\left(\frac{1-n}{2}, -\frac{n}{2}, \frac{1}{2}-n, \frac{1}{z^2}\right) = \frac{\sqrt{\pi}\Gamma(-n)}{\Gamma(\frac{1}{2}-n)} \frac{2^n}{c_0} w_1;$$

so that $Q_n(z)$ is again an integral.

Accordingly, $Q_n(z)$ is an integral for all values of n . It is known as *Legendre's Function of the Second Kind*. $P_n(z)$ is the more important of the Legendre functions when $|z| < 1$, and $Q_n(z)$ when $|z| > 1$.

Note. Thus far $P_n(z)$ has only been defined for positive integral or zero values of n , while $Q_n(z)$ has been defined for all values of n .

Relation between Legendre's Equation and Gauss's Equation.

If in Legendre's Equation we put $z=1-2\xi$, we obtain

$$\xi(1-\xi) \frac{d^2w}{d\xi^2} + (1-2\xi) \frac{dw}{d\xi} + n(n+1)w = 0,$$

which is Gauss's Equation with $\alpha=n+1$, $\beta=-n$, $\gamma=1$. Hence, in the vicinity of $z=1$, the two solutions are

$$F\left(-n, n+1, 1, \frac{1-z}{2}\right), \quad F\left(-n, n+1, 1, \frac{1-z}{2}\right) \log\left(\frac{1-z}{2}\right)$$

$$+ \sum_{\nu=1}^{\infty} \frac{-n(-n+1)\dots(-n+\nu-1)(n+1)(n+2)\dots(n+\nu)}{(\nu!)^2}$$

$$\times \left\{ \sum_{r=0}^{\nu-1} \left(\frac{1}{-n+r} + \frac{1}{n+1+r} \right) - \sum_{r=1}^{\nu} \frac{2}{r} \right\} \left(\frac{1-z}{2}\right)^{\nu}.$$

Definition of $P_n(z)$ for all Values of n . When n is a positive integer,

$$P_n(z) = \frac{1}{2^n(n!)} \frac{d^n}{dz^n} (z^2 - 1)^n = \frac{(-1)^n}{n!} \frac{d^n}{dz^n} \left\{ (1-z)^n \left(1 - \frac{1-z}{2}\right)^n \right\} \\ = F\left(-n, n+1, 1, \frac{1-z}{2}\right).$$

Now it has just been shewn that this function satisfies Legendre's Equation for all values of n . Accordingly, for all values of n we define $P_n(z)$ by the equation

$$P_n(z) = F\left(-n, n+1, 1, \frac{1-z}{2}\right).$$

COROLLARY. $P_n(z) = P_{-n-1}(z)$.

Example 1. If n is zero or a positive integer, shew that

$$Q_n(z) = \frac{1}{2} \int_{-1}^1 \frac{P_n(\zeta)}{z - \zeta} d\zeta$$

where the path of integration is taken so as not to pass through the point z , [Expand $1/(z - \zeta)$ in descending powers of z for $|z| > 1$, and evaluate the coefficients by partial integration. The theorem holds if $|z| < 1$, since the functions on both sides of the equation are holomorphic.]

Example 2. Use the series for $Q_n(z)$ to prove, for all values of n , the formulae:

- (i) $(n+1)Q_{n+1}(z) - (2n+1)zQ_n(z) + nQ_{n-1}(z) = 0$,
- (ii) $nQ_n(z) = zQ'_n(z) - Q'_{n-1}(z)$.

Example 3. Use the expression $P_n(z) = F\left(-n, n+1, 1, \frac{1-z}{2}\right)$ to prove, for all values of n , the formulae:

- (i) $(n+1)P_{n+1}(z) - (2n+1)zP_n(z) + nP_{n-1}(z) = 0$,
- (ii) $nP_n(z) = zP'_n(z) - P'_{n-1}(z)$.

Example 4. Shew that, for all values of n ,

- (i) $(n+1)\{P_{n+1}(z)Q_n(z) - Q_{n+1}(z)P_n(z)\} \\ = n\{P_n(z)Q_{n-1}(z) - Q_n(z)P_{n-1}(z)\}$,
- (ii) $(n+1)\{P_{n+1}(z)Q_{n-1}(z) - Q_{n+1}(z)P_{n-1}(z)\} \\ = (2n+1)z\{P_n(z)Q_{n-1}(z) - Q_n(z)P_{n-1}(z)\}$.

[Use Ex. 2, (i), and Ex. 3, (i).]

91. Bessel Functions. The equation

$$z^2 w'' + z w' + (z^2 - n^2) w = 0$$

is known as *Bessel's Equation*, and its integrals are called *Cylindrical Harmonics* or *Bessel Functions*.

The only singularities of Bessel's Equation are $z=0$ and $z=\infty$.

To solve in the vicinity of $z=0$, put $w=z^\rho \sum_0^\infty c_\nu z^\nu$; then

$$\sum_{\nu=0}^\infty \{(\rho+\nu)(\rho+\nu-1) + (\rho+\nu) - n^2\} c_\nu z^{\rho+\nu} + \sum_{\nu=0}^\infty c_\nu z^{\rho+\nu+2} = 0.$$

Hence $c_0(\rho^2 - n^2) = 0$; $c_1\{(\rho+1)^2 - n^2\} = 0$;
 $c_\nu\{(\rho+\nu)^2 - n^2\} = -c_{\nu-2}$, ($\nu=2, 3, 4, \dots$).

The indicial equation is $\rho^2 - n^2 = 0$: its roots are $\rho_1 = n, \rho_2 = -n$. If $\rho_1 - \rho_2$ is an integer, n must either be an integer or half an odd integer. The second equation gives $c_1 = 0$; so that $c_3 = c_5 = c_7 = \dots = 0$. Also

$$c_{2\nu} = (-1)^\nu \frac{c_0}{(\rho - n + 2)(\rho - n + 4) \dots (\rho - n + 2\nu)(\rho + n + 2) \times (\rho + n + 4) \dots (\rho + n + 2\nu)},$$

where $\nu = 1, 2, 3, \dots$

There are four cases to consider.

I. Let n be neither an integer nor half an odd integer. Then there are two independent solutions $J_n(z)$ and $J_{-n}(z)$, where

$$J_n(z) = \frac{z^n}{2^n \Pi(n)} \left\{ 1 - \frac{z^2}{2(2n+2)} + 2 \cdot \frac{z^4}{4(2n+2)(2n+4)} - \dots \right\}$$

$$= \sum_{\nu=0}^\infty \frac{(-1)^\nu}{\Pi(\nu)\Pi(n+\nu)} \left(\frac{z}{2}\right)^{n+2\nu}.$$

$J_n(z)$ is holomorphic for all finite values of z , except possibly $z=0$: it is known as *Bessel's Function of the First Kind of order n* .

If n is a positive integer, $J_n(z)$ is an integral. $J_{-n}(z)$, however, is not a linearly independent integral. For, since $1/\Pi(-n+\nu) = 0$, where $\nu = 0, 1, 2, \dots, n-1$,

$$J_{-n}(z) = \sum_{\nu=0}^\infty (-1)^{n+\nu} \frac{1}{\Pi(n+\nu)\Pi(\nu)} \left(\frac{z}{2}\right)^{n+2\nu}$$

$$= (-1)^n J_n(z).$$

II. Let n be half an odd integer; then, since the coefficients in $J_n(z)$ and $J_{-n}(z)$ are all finite, these two functions are linearly independent integrals in this case also.

III. Let $n=0$, so that the roots of the indicial equation are equal; then

$$w = z^\rho \sum_{\nu=0}^\infty \frac{(-1)^\nu z^{2\nu}}{(\rho+2)^2(\rho+4)^2 \dots (\rho+2\nu)^2}.$$

Hence

$$\frac{\partial w}{\partial \rho} = w \log z - 2z^\rho \sum_{\nu=1}^{\infty} \frac{(-1)^\nu z^{2\nu}}{(\rho+2)^2(\rho+4)^2 \dots (\rho+2\nu)^2} \sum_{r=1}^{\nu} \frac{1}{\rho+2r}.$$

Thus the two integrals are

$$J_0(z) = \sum_{\nu=0}^{\infty} \frac{(-1)^\nu}{(\nu!)^2} \left(\frac{z}{2}\right)^{2\nu},$$

and

$$Y_0(z) = J_0(z) \log z + \frac{z^2}{2^2} - \frac{z^4}{2^2 \cdot 4^2} \left(1 + \frac{1}{2}\right) + \frac{z^6}{2^2 \cdot 4^2 \cdot 6^2} \left(1 + \frac{1}{2} + \frac{1}{3}\right) - \dots$$

$Y_0(z)$ is called *Bessel's Function of the Second Kind of order zero*.

IV. Let n be a positive non-zero integer; then, if $c_0 = c(\rho+n)$,

$$w = cz^\rho \sum_{\nu=0}^{\infty} \frac{(-1)^\nu (\rho+n) z^{2\nu}}{(\rho-n+2)(\rho-n+4) \dots (\rho-n+2\nu)(\rho+n+2) \times (\rho+n+4) \dots (\rho+n+2\nu)}.$$

Hence

$$\begin{aligned} \frac{\partial w}{\partial \rho} &= w \log z + (\rho+n)c \\ &\times \frac{\partial}{\partial \rho} \left\{ z^\rho \sum_{\nu=0}^{n-1} \frac{(-1)^\nu z^{2\nu}}{(\rho-n+2) \dots (\rho-n+2\nu)(\rho+n+2) \dots (\rho+n+2\nu)} \right\} \\ &+ cz^\rho \sum_{\nu=0}^{n-1} \frac{(-1)^\nu z^{2\nu}}{(\rho-n+2) \dots (\rho-n+2\nu)(\rho+n+2) \dots (\rho+n+2\nu)} \\ &- (-1)^n c \frac{z^{\rho+2n}}{(\rho-n+2) \dots (\rho+n-2)(\rho+n+2) \dots (\rho+3n)} \\ &\times \sum_{\nu=0}^{\infty} \frac{(-1)^\nu z^{2\nu}}{(\rho+n+2) \dots (\rho+n+2\nu)(\rho+3n+2) \dots (\rho+3n+2\nu)} \\ &\times \left\{ \sum_{r=1}^{n-1} \frac{1}{\rho-n+2r} + \sum_{r=1}^n \frac{1}{\rho+n+2r} + \sum_{r=1}^{\nu} \frac{1}{\rho+n+2r} + \sum_{r=1}^{\nu} \frac{1}{\rho+3n+2r} \right\}. \end{aligned}$$

Accordingly, if $\rho = -n$,

$$w = -c \frac{z^n}{2 \cdot 4 \dots 2n \cdot 2 \cdot 4 \dots (2n-2)} \times \left\{ 1 - \frac{z^2}{2(2n+2)} + \frac{z^4}{2 \cdot 4(2n+2)(2n+4)} - \dots \right\},$$

$$\begin{aligned} \frac{\partial w}{\partial \rho} &= w \log z + cz^{-n} \sum_{\nu=0}^{n-1} \frac{z^{2\nu}}{2 \cdot 4 \dots 2\nu(2n-2)(2n-4) \dots (2n-2\nu)} \\ &+ c \frac{1}{2} \frac{z^n}{2 \cdot 4 \dots 2n \cdot 2 \cdot 4 \dots (2n-2)} \\ &\times \sum_{\nu=0}^{\infty} \frac{(-1)^\nu z^{2\nu}}{2 \cdot 4 \dots 2\nu(2n+2)(2n+4) \dots (2n+2\nu)} \left\{ \sum_{r=1}^{\nu} \frac{1}{r} + \sum_{r=0}^{\nu} \frac{1}{n+r} \right\}. \end{aligned}$$

If these two integrals are multiplied by $-2^{n-1}(n-1)!/c$, they become $J_n(z)$, and

$$J_n(z) \log z - \frac{1}{2} \sum_{\nu=0}^{n-1} \frac{(n-\nu-1)!}{\nu!} \left(\frac{z}{2}\right)^{-n+2\nu} - \frac{1}{2} \sum_{\nu=0}^{\infty} \frac{(-1)^\nu}{\nu!(n+\nu)!} \left(\frac{z}{2}\right)^{n+2\nu} \left\{ \sum_{r=1}^{\nu} \frac{1}{r} + \sum_{r=0}^{\nu} \frac{1}{n+r} \right\}.$$

Subtracting $\frac{1}{2} \left(\frac{1}{1} + \frac{1}{2} + \dots + \frac{1}{n-1} \right) J_n(z)$ from the latter integral, we obtain the integral,

$$Y_n(z) = J_n(z) \log z - \frac{1}{2} \sum_{\nu=0}^{n-1} \frac{(n-\nu-1)!}{\nu!} \left(\frac{z}{2}\right)^{-n+2\nu} - \frac{1}{2} \sum_{\nu=0}^{\infty} \frac{(-1)^\nu}{\nu!(n+\nu)!} \left(\frac{z}{2}\right)^{n+2\nu} \{ \phi(\nu) + \phi(n+\nu) \},$$

where $\phi(r) = \frac{1}{1} + \frac{1}{2} + \dots + \frac{1}{r}$, ($r = 1, 2, 3, \dots$), and $\phi(0) = 0$.

$Y_n(z)$ is called *Bessel's Function of the Second Kind of order n*.

Recurrence Formulae. We leave as an exercise to the reader the verification of the following formulae :

- (i) $2J_n'(z) = J_{n-1}(z) - J_{n+1}(z)$;
- (ii) $J_0'(z) = -J_1(z)$;
- (iii) $\frac{2n}{z} J_n(z) = J_{n-1}(z) + J_{n+1}(z)$.

$J_n(z)$ as a *Function of n*. Let $|z| \leq R$, $|n| \leq N$; then, if m is an integer such that $m - N > -1$, and if

$$T_\nu(z) = \frac{\left(\frac{z}{2}\right)^{2\nu}}{\nu!(n+m+1)(n+m+2)\dots(n+\nu)},$$

$$M_\nu = \frac{\left(\frac{R}{2}\right)^{2\nu}}{\nu!(m-N+1)(m-N+2)\dots(\nu-N)},$$

($\nu = m+1, m+2, \dots$),

then $|T_\nu(z)| \leq M_\nu$. But $\sum_{m+1}^{\infty} M_\nu$ is convergent; consequently, by Weierstrass's M Test, $\sum_{m+1}^{\infty} T_\nu(z)$ is uniformly convergent if $|z| \leq R$, $|n| \leq N$.

Now R and N can be chosen so large that these regions enclose any assigned finite points z and n . Accordingly, for all finite values of z , except possibly $z=0$, $J_n(z)$ is a holomorphic function of n .

*The Bessel Function $G_n(z)$.** It is sometimes found convenient, instead of $J_{-n}(z)$ or $Y_n(z)$, to take as the second solution of Bessel's Equation the function

$$G_n(z) = \frac{\pi}{2 \sin n\pi} \{J_{-n}(z) - e^{-in\pi} J_n(z)\},$$

where the limiting value of the expression on the right-hand side is taken for $G_n(z)$ when n is an integer.

Now

$$\frac{\partial}{\partial n} J_n(z) = J_n(z) \log \left(\frac{z}{2}\right) - \sum_{\nu=0}^{\infty} \frac{(-1)^\nu}{\nu! \Gamma(n+\nu+1)} \left(\frac{z}{2}\right)^{n+2\nu} \psi(n+\nu).$$

Also

$$J_{-n}(z) = \sum_{\nu=0}^{n-1} \frac{(-1)^\nu}{\nu!} \left(\frac{z}{2}\right)^{-n+2\nu} \Gamma(n-\nu) \frac{\sin(n-\nu)\pi}{\pi} \\ + \sum_{\nu=p}^{\infty} \frac{(-1)^\nu}{\nu! \Gamma(-n+\nu+1)} \left(\frac{z}{2}\right)^{-n+2\nu};$$

so that

$$\frac{\partial}{\partial n} J_{-n}(z) = -J_{-n}(z) \log \left(\frac{z}{2}\right) \\ + \sum_{\nu=0}^{p-1} (-1)^\nu \left(\frac{z}{2}\right)^{-n+2\nu} \frac{\Gamma'(n-\nu) \sin(n-\nu)\pi + \Gamma(n-\nu) \cdot \pi \cos(n-\nu)\pi}{\pi \cdot \nu!} \\ + \sum_{\nu=p}^{\infty} \frac{(-1)^\nu}{\nu! \Gamma(-n+\nu+1)} \left(\frac{z}{2}\right)^{-n+2\nu} \psi(-n+\nu).$$

If n is a positive integer, let $p=n$; then

$$\frac{\partial}{\partial n} J_{-n}(z) = -J_{-n}(z) \log \left(\frac{z}{2}\right) + (-1)^n \sum_{\nu=0}^{n-1} \frac{(n-\nu-1)!}{\nu!} \left(\frac{z}{2}\right)^{-n+2\nu} \\ + (-1)^n \sum_{\nu=0}^{\infty} \frac{(-1)^\nu}{\nu! (n+\nu)!} \psi(\nu) \left(\frac{z}{2}\right)^{n+2\nu}.$$

Accordingly, if n is a positive integer,

$$G_n(z) = \frac{\partial}{\partial n} \{J_{-n}(z) - e^{-in\pi} J_n(z)\} \\ = -Y_n(z) + J_n(z) \left\{ \log 2 - \gamma + \frac{i\pi}{2} \right\}.$$

* Cf. J. Dougall, *Proc. Edin. Math. Soc.*, Vol. XVIII. p. 36.

The verification of the following formulae is left as an exercise to the reader :

- (i) $G_{-n}(z) = e^{in\pi} G_n(z)$;
 (ii) $2G_n'(z) = G_{n-1}(z) - G_{n+1}(z)$;
 (iii) $\frac{2n}{z} G_n(z) = G_{n-1}(z) + G_{n+1}(z)$.

THEOREM. If $P(z)$ and $Q(z)$ are any solutions of Bessel's Equation, they satisfy a relation of the form

$$P(z)Q'(z) - P'(z)Q(z) = \frac{C}{z},$$

where C is a constant.

For, if the substitution $w = z^{-1/2}W$ is made in Bessel's Equation, it becomes

$$\frac{d^2W}{dz^2} + \left(1 - \frac{n^2 - 1/4}{z^2}\right)W = 0.$$

Consequently

$$\{\sqrt{z}P(z)\} \frac{d^2}{dz^2} \{\sqrt{z}Q(z)\} - \{\sqrt{z}Q(z)\} \frac{d^2}{dz^2} \{\sqrt{z}P(z)\} = 0.$$

Hence, integrating, we have

$$\{\sqrt{z}P(z)\} \frac{d}{dz} \{\sqrt{z}Q(z)\} - \{\sqrt{z}Q(z)\} \frac{d}{dz} \{\sqrt{z}P(z)\} = C ;$$

so that

$$P(z)Q'(z) - P'(z)Q(z) = \frac{C}{z}.$$

For example,

$$\begin{aligned} \lim_{z \rightarrow 0} z \{J_n(z)J'_{-n}(z) - J'_{-n}(z)J_n(z)\} \\ = \frac{1}{\Gamma(n+1)} \frac{1}{\Gamma(-n)} - \frac{1}{\Gamma(-n+1)} \frac{1}{\Gamma(n)} = -2 \frac{\sin n\pi}{\pi} ; \end{aligned}$$

and therefore

$$J_n(z)J'_{-n}(z) - J'_{-n}(z)J_n(z) = -2 \frac{\sin n\pi}{\pi z}.$$

The reader can easily deduce that :

- (i) $G_n(z)J_n'(z) - G_n'(z)J_n(z) = \frac{1}{z}$;
 (ii) $J_n(z)J_{-n+1}(z) + J_{-n}(z)J_{n-1}(z) = \frac{-J_n(z)J_{-n-1}(z) - J_{-n}(z)J_{n+1}(z)}{2} = 2 \frac{\sin n\pi}{\pi z}$;
 (iii) $G_{n+1}(z)J_n(z) - J_{n+1}(z)G_n(z) = \frac{1}{z}$.

The Zeros of $J_n(z)$. If n is real and greater than -1 , all the zeros of $J_n(z)$ are real and distinct, except possibly $z=0$; this can be shewn as follows.

$$\text{We have } z^2 \frac{d^2}{dz^2} J_n(\alpha z) + z \frac{d}{dz} J_n(\alpha z) + (\alpha^2 z^2 - n^2) J_n(\alpha z) = 0,$$

and

$$z^2 \frac{d^2}{dz^2} J_n(\beta z) + z \frac{d}{dz} J_n(\beta z) + (\beta^2 z^2 - n^2) J_n(\beta z) = 0.$$

Thus, multiplying the first equation by $J_n(\beta z)$, and the second by $J_n(\alpha z)$, and subtracting, we have

$$(\alpha^2 - \beta^2) z J_n(\alpha z) J_n(\beta z) = \frac{d}{dz} z \{J_n(\alpha z) \frac{d}{dz} J_n(\beta z) - J_n(\beta z) \frac{d}{dz} J_n(\alpha z)\}.$$

Hence, if $R(n) > -1$,

$$(\alpha^2 - \beta^2) \int_0^z z J_n(\alpha z) J_n(\beta z) dz = z \left\{ J_n(\alpha z) \frac{d}{dz} J_n(\beta z) - J_n(\beta z) \frac{d}{dz} J_n(\alpha z) \right\}.$$

Therefore, if $\theta = \alpha$ and $\theta = \beta$ are distinct zeros of $J_n(\theta c)$,

$$\int_0^c z J_n(\alpha z) J_n(\beta z) dz = 0.$$

Again, let $\beta = \alpha + \epsilon$; then

$$\begin{aligned} & (-2\alpha\epsilon - \epsilon^2) \int_0^z z J_n(\alpha z) \left\{ J_n(\alpha z) + \epsilon \frac{\partial}{\partial \alpha} J_n(\alpha z) + \dots \right\} dz \\ &= z J_n(\alpha z) \left\{ \frac{d}{dz} J_n(\alpha z) + \frac{\epsilon z}{\alpha} \frac{d^2}{dz^2} J_n(\alpha z) + \dots \right\} \\ &\quad - z \frac{d}{dz} J_n(\alpha z) \left\{ J_n(\alpha z) + \frac{\epsilon z}{\alpha} \frac{d}{dz} J_n(\alpha z) + \dots \right\}. \end{aligned}$$

If this equation is divided by ϵ , and ϵ is then made to tend to zero, the equation becomes

$$2\alpha \int_0^z z \{J_n(\alpha z)\}^2 dz = -\frac{z^2}{\alpha} \left[J_n(\alpha z) \frac{d^2}{dz^2} J_n(\alpha z) - \left\{ \frac{d}{dz} J_n(\alpha z) \right\}^2 \right].$$

Hence, if $\theta = \alpha$ is any zero of $J_n(\theta c)$, except $\theta = 0$,

$$\int_0^c z \{J_n(\alpha z)\}^2 dz = \frac{c^2}{2} \{J_n'(\alpha c)\}^2.$$

THEOREM I. If n is real and greater than -1 , $J_n(z)$ cannot have any purely imaginary zeros.

$$\text{For } \frac{J_n(iy)}{(iy)^n} = \frac{1}{2^n \Gamma(n+1)} \left\{ 1 + \frac{y^2}{2(2n+2)} + \frac{y^4}{2 \cdot 4 \cdot (2n+2)(2n+4)} + \dots \right\},$$

and the latter expression cannot vanish if y is real.

THEOREM II. If n is real and greater than -1 , $J_n(z)$ cannot have a complex zero.

For if $z = p + iq$ is a zero, where p and q are real, $z = p - iq$ must also be a zero; hence

$$\int_0^1 x J_n\{(p+iq)x\} J_n\{(p-iq)x\} dx = 0.$$

But if n and x are real, the integrand is positive; and therefore the integral cannot be zero. Thus the theorem must hold.

Accordingly, if n is real and greater than -1 , it follows that every zero of $J_n(z)$ must be real.

THEOREM III. If n is real and greater than -1 , $J_n(z)$ has no repeated zeros except possibly $z = 0$.

For if $z = \alpha$ is a zero,

$$\int_0^1 x \{J_n(x)\}^2 dx = \frac{1}{2} \{J_n'(\alpha)\}^2;$$

so that $J_n'(\alpha) \neq 0$. Thus $J_n(z)$ has no repeated zeros.

THEOREM IV. If n is real and greater than -1 , $J_n(z)$ and $J_{n+1}(z)$ have no common zeros except possibly $z=0$.

This follows from the formula

$$J_n'(z) - \frac{n}{z} J_n(z) = -J_{n+1}(z).$$

92. Equations of Fuchsian Type. Equations whose coefficients are meromorphic in the entire plane, and which have their integrals regular in the vicinity of all their singularities, are called *Equations of Fuchsian Type*.

If the singularities are $a_1, a_2, a_3, \dots, a_n$, and infinity, the equation is of the form

$$\frac{d^2w}{dz^2} = \frac{P_{n-1}(z)}{(z-a_1)(z-a_2)\dots(z-a_n)} \frac{dw}{dz} + \frac{P_{2n-2}(z)}{(z-a_1)^2(z-a_2)^2\dots(z-a_n)^2} w,$$

where $P_{n-1}(z)$ and $P_{2n-2}(z)$ are polynomials of degrees $n-1$ and $2n-2$ respectively (§ 87).

If infinity is not a singularity, the equation is of the form

$$\frac{d^2w}{dz^2} = \frac{P_{n-1}(z)}{(z-a_1)(z-a_2)\dots(z-a_n)} \frac{dw}{dz} + \frac{P_{2n-4}(z)}{(z-a_1)^2(z-a_2)^2\dots(z-a_n)^2} w,$$

where the coefficient of the highest term in $P_{n-1}(z)$ is -2 (§ 83, p. 212).

THEOREM. The sum of the indices associated with the singularities $a_1, a_2, \dots, a_n, \infty$, of the equation of Fuchsian Type is $n-1$.

Let
$$P_{n-1}(z) = Az^{n-1} + Bz^{n-2} + \dots,$$

and let
$$\psi(z) = (z-a_1)(z-a_2)\dots(z-a_n).$$

Then the indicial equation for the singularity a_r is

$$\rho(\rho-1) = \rho \frac{P_{n-1}(a_r)}{\psi'(a_r)} + \text{terms independent of } \rho.$$

Accordingly, if the roots of the indicial equation are ρ_1 and ρ_2

$$\rho_1 + \rho_2 = 1 + \frac{P_{n-1}(a_r)}{\psi'(a_r)}.$$

Now, by the theory of partial fractions,

$$\frac{P_{n-1}(z)}{\psi(z)} = \sum_{r=1}^n \frac{P_{n-1}(a_r)}{(z-a_r)\psi'(a_r)}.$$

Hence, integrating round a large circle which encloses a_1, a_2, \dots, a_n , we have

$$\sum_{r=1}^n \frac{P_{n-1}(a_r)}{\psi'(a_r)} = \frac{1}{2\pi i} \int \frac{P_{n-1}(z)}{\psi(z)} dz = A,$$

since
$$\lim_{z \rightarrow \infty} z \frac{P_{n-1}(z)}{\psi(z)} = A.$$

Thus the sum of the indices at a_1, a_2, \dots, a_n , is $n + A$.

Again, put $z = 1/\xi$; then the equation becomes

$$\frac{d^2 w}{d\xi^2} = \frac{1}{\xi} \frac{dw}{d\xi} \left\{ -2 - A + B'\xi + \dots \right\} + \frac{1}{\xi^2} w(A'' + B''\xi + \dots).$$

Thus the indicial equation is

$$\rho(\rho - 1) = \rho(-2 - A) + A'';$$

so that

$$\rho_1 + \rho_2 = -1 - A.$$

Hence the sum of the indices is $n - 1$.

COROLLARY. If infinity is not a singularity, $A = -2$, and therefore the sum of the indices is $n - 2$.

93. Riemann's P-function. We shall now investigate the conditions that the equation

$$\frac{d^2 w}{dz^2} = \frac{P_{n-1}(z)}{\psi(z)} \frac{dw}{dz} + \frac{P_{2n-2}(z)}{\{\psi(z)\}^2} w,$$

should be completely determined if the $n+1$ singularities $a_1, a_2, \dots, a_n, \infty$, and the corresponding indices, are assigned.

There are $3n - 1$ constants to be determined in the equation. The assigning of the singularities $a_1, a_2, \dots, a_n, \infty$, simply determines $\psi(z)$ and the degrees of $P_{n-1}(z)$ and $P_{2n-2}(z)$. The assigning of the $2n+2$ indices determines only $2n+1$ constants, since the indices must satisfy the condition that their sum is $n - 1$.

Thus $n - 2$ constants remain to be determined; so that, if $n = 2$, the equation is completely determined.

Similarly, when infinity is not a singularity of the equation, there are $n - 3$ constants to be determined; so that the equation is completely determined if $n = 3$.

Consequently, in both cases, if there are three singularities, and if the indices are given, the equation is completely determined.

By means of the transformation

$$\frac{z-h}{z-k} = \frac{c-b}{c-a} \frac{\xi-a}{\xi-b},$$

the equation with singularities h, k, ∞ , can be transformed into an equation with singularities a, b, c . The equation can therefore always be put in the form

$$\frac{d^2w}{dz^2} = \left\{ \frac{f}{z-a} + \frac{g}{z-b} + \frac{h}{z-c} \right\} \frac{dw}{dz} + \left\{ \frac{l}{z-a} + \frac{m}{z-b} + \frac{n}{z-c} \right\} \frac{w}{(z-a)(z-b)(z-c)},$$

where $f+g+h = -2$.

Let the indices at a, b, c , be λ and λ' , μ and μ' , ν and ν' , respectively, where $\lambda + \lambda' + \mu + \mu' + \nu + \nu' = 1$. Then, since the indicial equation at a is

$$\rho(\rho-1) = f\rho + \frac{l}{(a-b)(a-c)},$$

$$1+f = \lambda + \lambda', \quad l = -\lambda\lambda'(a-b)(a-c);$$

so that

$$f = \lambda + \lambda' - 1.$$

Similarly $g = \mu + \mu' - 1, \quad m = -\mu\mu'(b-c)(b-a),$

$$h = \nu + \nu' - 1, \quad n = -\nu\nu'(c-a)(c-b).$$

Hence the equation can be written

$$\begin{aligned} \frac{d^2w}{dz^2} + \left(\frac{1-\lambda-\lambda'}{z-a} + \frac{1-\mu-\mu'}{z-b} + \frac{1-\nu-\nu'}{z-c} \right) \frac{dw}{dz} \\ + \left\{ \frac{\lambda\lambda'(a-b)(a-c)}{z-a} + \frac{\mu\mu'(b-c)(b-a)}{z-b} + \frac{\nu\nu'(c-a)(c-b)}{z-c} \right\} \\ \times \frac{w}{(z-a)(z-b)(z-c)} = 0. \end{aligned}$$

Now for simplicity assume that $\lambda - \lambda', \mu - \mu', \nu - \nu'$, are not integers; then, if $P_\lambda, P_{\lambda'}, P_\mu, P_{\mu'}, P_\nu, P_{\nu'}$, are integrals corresponding to the indices $\lambda, \lambda', \mu, \mu', \nu, \nu'$, any branch of any integral of the equation can be expressed in any of the forms

$$c_\lambda P_\lambda + c_{\lambda'} P_{\lambda'}, \quad c_\mu P_\mu + c_{\mu'} P_{\mu'}, \quad c_\nu P_\nu + c_{\nu'} P_{\nu'}.$$

Riemann denotes such a function by

$$P \left\{ \begin{matrix} a, & b, & c, \\ \lambda, & \mu, & \nu, & z \\ \lambda', & \mu', & \nu', & \end{matrix} \right\};$$

and it is called *Riemann's P-function*. If either λ and λ' , μ and μ' , or ν and ν' , are interchanged, the differential equation remains unaltered. Likewise the three columns can be interchanged without altering the equation. Again, if the function is multiplied by $(z-a)^\sigma(z-c)^\rho(z-b)^{-\sigma-\rho}$, the indices at a, b , and

c , become $\lambda + \sigma$ and $\lambda' + \sigma$, $\mu - \sigma - \rho$ and $\mu' - \sigma - \rho$, $\nu + \rho$ and $\nu' + \rho$, while the branches of the function remain holomorphic at all other points, including infinity. Also the sum of the indices is still unity. Consequently

$$\frac{(z-a)^\sigma(z-c)^\rho}{(z-b)^{\sigma+\rho}} P \left\{ \begin{matrix} a, & b, & c, \\ \lambda, & \mu, & \nu, & z \\ \lambda', & \mu', & \nu', & \end{matrix} \right\} = P \left\{ \begin{matrix} a, & b, & c, \\ \lambda + \sigma, & \mu - \sigma - \rho, & \nu + \rho, & z \\ \lambda' + \sigma, & \mu' - \sigma - \rho, & \nu' + \rho, & \end{matrix} \right\}.$$

Again, the transformation

$$\xi = \frac{z-a}{z-b} \frac{c-b}{c-a}$$

changes a, b, c , into $0, \infty, 1$. When the latter three points are the singularities of the equation, the function is denoted by

$$P \left\{ \begin{matrix} \lambda, & \mu, & \nu, & z \\ \lambda', & \mu', & \nu', & \end{matrix} \right\}.$$

Also
$$\frac{(z-a)^\sigma(z-c)^\rho}{(z-b)^{\sigma+\rho}} = K \xi^\sigma (1-\xi)^\rho,$$

where K is a constant; thus

$$z^\sigma(1-z)^\rho P \left\{ \begin{matrix} \lambda, & \mu, & \nu, & z \\ \lambda', & \mu', & \nu', & \end{matrix} \right\} = P \left\{ \begin{matrix} \lambda + \sigma, & \mu - \sigma - \rho, & \nu + \rho, & z \\ \lambda' + \sigma, & \mu' - \sigma - \rho, & \nu' + \rho, & \end{matrix} \right\}.$$

The differential equation determined by $P \left\{ \begin{matrix} \lambda, & \mu, & \nu, & z \\ \lambda', & \mu', & \nu', & \end{matrix} \right\}$ is obtained by putting $a=0, c=1$, and making b tend to infinity; it can, by means of the equation $\lambda + \lambda' + \mu + \mu' + \nu + \nu' = 1$, be put in the form

$$\frac{d^2w}{dz^2} + \frac{(1-\lambda-\lambda')-(1+\mu+\mu')z}{z(1-z)} \frac{dw}{dz} + \frac{\lambda\lambda' - (\lambda\lambda' + \mu\mu' - \nu\nu')z + \mu\mu'z^2}{z^2(1-z)^2} w = 0.$$

In particular, the function $P \left(\begin{matrix} 0, & \alpha, & 0 \\ 1-\gamma, & \beta, & \gamma-\alpha-\beta, & z \end{matrix} \right)$ satisfies the hypergeometric equation

$$z(1-z)w'' + \{\gamma - (\alpha + \beta + 1)z\}w' - \alpha\beta w = 0.$$

Note. Since

$$z^{-\lambda}(1-z)^{-\nu} P \left(\begin{matrix} \lambda, & \mu, & \nu, & z \\ \lambda', & \mu', & \nu', & \end{matrix} \right) = P \left(\begin{matrix} 0, & \alpha, & 0 \\ 1-\gamma, & \beta, & \gamma-\alpha-\beta, & z \end{matrix} \right),$$

where $\alpha = \lambda + \mu + \nu$, $\beta = \lambda + \mu' + \nu$, $\gamma = 1 - \lambda' + \lambda$, it follows that the P -function can always be expressed in terms of the integrals of the hypergeometric equation.

The Twenty-four Integrals of the Hypergeometric Equation.
 The solutions corresponding to the indices 0, $1-\gamma$, at $z=0$ are (§ 89),

$$F(\alpha, \beta, \gamma, z), z^{1-\gamma}F(\alpha-\gamma+1, \beta-\gamma+1, 2-\gamma, z):$$

we denote them by $W_1^{(0)}$ and $W_2^{(0)}$ respectively.

Alternative forms for $W_1^{(0)}$ and $W_2^{(0)}$ are obtained as follows. We have

$$(1-z)^{\alpha+\beta-\gamma}P\left(\begin{matrix} 0, & \alpha, & 0, \\ 1-\gamma, & \beta, & \gamma-\alpha-\beta, \end{matrix} z\right) \\ = P\left(\begin{matrix} 0, & \gamma-\beta, & \alpha+\beta-\gamma, \\ 1-\gamma, & \gamma-\alpha, & 0, \end{matrix} z\right).$$

Thus

$$(1-z)^{\gamma-\alpha-\beta}F(\gamma-\alpha, \gamma-\beta, \gamma, z) = C_1W_1^{(0)} + C_2W_2^{(0)}.$$

But, since the function on the left-hand side is uniform at $z=0$, $C_2=0$; hence

$$(1-z)^{\gamma-\alpha-\beta}F(\gamma-\alpha, \gamma-\beta, \gamma, z) = C_1W_1^{(0)}.$$

In this equation let $z=0$; then $1=C_1$. Therefore

$$W_1^{(0)} = (1-z)^{\gamma-\alpha-\beta}F(\gamma-\alpha, \gamma-\beta, \gamma, z).$$

It follows that

$$W_2^{(0)} = z^{1-\gamma}(1-z)^{\gamma-\alpha-\beta}F(1-\alpha, 1-\beta, 2-\gamma, z).$$

In like manner alternative forms can be found for the regular integrals at infinity and $z=1$.

Again, the six transformations,

$$z = \xi, z = 1 - \xi, z = 1/\xi, z = (\xi - 1)/\xi, z = \xi/(\xi - 1), z = 1/(1 - \xi),$$

when applied any number of times in any order, change the points 0, ∞ , 1, into the same three points in different orders. By means of these transformations new forms can therefore be obtained for the integrals. For example,

$$W_1^{(0)} = F(\alpha, \beta, \gamma, z) = P\left(\begin{matrix} 0, & \alpha, & 0, \\ 1-\gamma, & \beta, & \gamma-\alpha-\beta, \end{matrix} z\right) \\ = P\left(\begin{matrix} 0, & 0, & \alpha, \\ 1-\gamma, & \gamma-\alpha-\beta, & \beta, \end{matrix} \xi\right), \text{ where } \xi = \frac{z}{z-1}, \\ = (1-\xi)^\alpha P\left(\begin{matrix} 0, & \alpha, & 0, \\ 1-\gamma, & \gamma-\beta, & \beta-\alpha, \end{matrix} \xi\right) \\ = C(1-z)^{-\alpha}F\left(\alpha, \gamma-\beta, \gamma, \frac{z}{z-1}\right).$$

In this equation let $z=0$; then $C=1$. Hence

$$\begin{aligned} W_1^{(0)} &= (1-z)^{-\alpha} F\left(\alpha, \gamma-\beta, \gamma, \frac{z}{z-1}\right) \\ &= (1-z)^{-\beta} F\left(\beta, \gamma-\alpha, \gamma, \frac{z}{z-1}\right). \end{aligned}$$

These two expressions for $W_1^{(0)}$ are valid if $R(z) < 1/2$.

We have thus obtained four different forms for $W_1^{(0)}$. Similarly four different forms can be found for $W_2^{(0)}$, $W_1^{(1)}$, $W_2^{(1)}$, $W_1^{(\infty)}$, $W_2^{(\infty)}$. These twenty-four forms for the integrals of the hypergeometric equation are:

- I. $W_1^{(0)} = F(\alpha, \beta, \gamma, z)$
- II. $= (1-z)^{\gamma-\alpha-\beta} F(\gamma-\alpha, \gamma-\beta, \gamma, z)$
- III. $= (1-z)^{-\alpha} F\left(\alpha, \gamma-\beta, \gamma, \frac{z}{z-1}\right)$
- IV. $= (1-z)^{-\beta} F\left(\beta, \gamma-\alpha, \gamma, \frac{z}{z-1}\right);$
- V. $W_2^{(0)} = z^{1-\gamma} F(\alpha-\gamma+1, \beta-\gamma+1, 2-\gamma, z)$
- VI. $= z^{1-\gamma} (1-z)^{\gamma-\alpha-\beta} F(1-\alpha, 1-\beta, 2-\gamma, z)$
- VII. $= z^{1-\gamma} (1-z)^{\gamma-\alpha-1} F\left(\alpha-\gamma+1, 1-\beta, 2-\gamma, \frac{z}{z-1}\right)$
- VIII. $= z^{1-\gamma} (1-z)^{\gamma-\beta-1} F\left(\beta-\gamma+1, 1-\alpha, 2-\gamma, \frac{z}{z-1}\right);$
- IX. $W_1^{(1)} = F(\alpha, \beta, \alpha+\beta-\gamma+1, 1-z)$
- X. $= z^{1-\gamma} F(\alpha-\gamma+1, \beta-\gamma+1, \alpha+\beta-\gamma+1, 1-z)$
- XI. $= z^{-\alpha} F\left(\alpha, \alpha-\gamma+1, \alpha+\beta-\gamma+1, \frac{z-1}{z}\right)$
- XII. $= z^{-\beta} F\left(\beta, \beta-\gamma+1, \alpha+\beta-\gamma+1, \frac{z-1}{z}\right);$
- XIII. $W_2^{(1)} = (1-z)^{\gamma-\alpha-\beta} F(\gamma-\alpha, \gamma-\beta, \gamma-\alpha-\beta+1, 1-z)$
- XIV. $= z^{1-\gamma} (1-z)^{\gamma-\alpha-\beta} F(1-\alpha, 1-\beta, \gamma-\alpha-\beta+1, 1-z)$
- XV. $= z^{\alpha-\gamma} (1-z)^{\gamma-\alpha-\beta} F\left(1-\alpha, \gamma-\alpha, \gamma-\alpha-\beta+1, \frac{z-1}{z}\right)$
- XVI. $= z^{\beta-\gamma} (1-z)^{\gamma-\alpha-\beta} F\left(1-\beta, \gamma-\beta, \gamma-\alpha-\beta+1, \frac{z-1}{z}\right);$
- XVII. $W_1^{(\infty)} = z^{-\alpha} F\left(\alpha, \alpha-\gamma+1, \alpha-\beta+1, \frac{1}{z}\right)$

- XVIII. $= z^{\beta-\gamma}(z-1)^{\gamma-\alpha-\beta}F\left(1-\beta, \gamma-\beta, \alpha-\beta+1, \frac{1}{z}\right)$
- XIX. $= (z-1)^{-\alpha}F\left(\alpha, \gamma-\beta, \alpha-\beta+1, \frac{1}{1-z}\right)$
- XX. $= z^{1-\gamma}(z-1)^{\gamma-\alpha-1}F\left(\alpha-\gamma+1, 1-\beta, \alpha-\beta+1, \frac{1}{1-z}\right);$
- XXI. $W_2^{(\infty)} = z^{-\beta}F\left(\beta, \beta-\gamma+1, \beta-\alpha+1, \frac{1}{z}\right)$
- XXII. $= z^{\alpha-\gamma}(z-1)^{\gamma-\alpha-\beta}F\left(1-\alpha, \gamma-\alpha, \beta-\alpha+1, \frac{1}{z}\right)$
- XXIII. $= (z-1)^{-\beta}F\left(\beta, \gamma-\alpha, \beta-\alpha+1, \frac{1}{1-z}\right)$
- XXIV. $= z^{1-\gamma}(z-1)^{\gamma-\beta-1}F\left(\beta-\gamma+1, 1-\alpha, \beta-\alpha+1, \frac{1}{1-z}\right).$

Relations of the form

$$W_r^{(s)} = C_1 W_1^{(t)} + C_2 W_2^{(t)},$$

where $r=1, 2; s=0, 1, \infty; t=0, 1, \infty;$

hold between the six functions $W_1^{(0)}, W_2^{(0)}, W_1^{(1)}, W_2^{(1)}, W_1^{(\infty)}, W_2^{(\infty)}$. One of these relations is given in Example 4 of § 63, and the others can be found by similar methods.

Example. Shew that, if $\gamma-\alpha-\beta$ is not an integer, the analytical continuation of $F(\alpha, \beta, \gamma, z)$ in the vicinity of $z=1$ is

$$\frac{\Gamma(\gamma-\alpha-\beta)\Gamma(\gamma)}{\Gamma(\gamma-\alpha)\Gamma(\gamma-\beta)} F(\alpha, \beta, \alpha+\beta-\gamma+1, 1-z) + \frac{\Gamma(\alpha+\beta-\gamma)\Gamma(\gamma)}{\Gamma(\alpha)\Gamma(\beta)} (1-z)^{\gamma-\alpha-\beta} F(\gamma-\alpha, \gamma-\beta, \gamma-\alpha-\beta+1, 1-z).$$

[Apply Ex. 4, § 63, to form III. of $W_1^{(0)}$.]

94. Spherical Harmonics. The equation

$$(1-z^2)\frac{d^2w}{dz^2} - 2z\frac{dw}{dz} + \left\{n(n+1) - \frac{m^2}{1-z^2}\right\}w = 0$$

is called *Legendre's Associated Equation*. The integrals of this equation are called *Spherical Harmonics of degree n and rank m* . The most important cases are when n and m are positive integers, such that $m \leq n$.

If $m=0$, the Harmonic is a *Legendre Function* or *Zonal Harmonic*.

If $m=1, 2, 3, \dots, n-1$, the Harmonic is a *Tesseral Harmonic*.

If $m=n$, the Harmonic is a *Sectorial Harmonic*.

Let the substitution $w = (z^2 - 1)^{\frac{1}{2}} W$ be made in Legendre's Associated Equation; then

$$(1 - z^2) \frac{d^2 W}{dz^2} - 2(m+1)z \frac{dW}{dz} + (n-m)(n+m+1)W = 0.$$

Again, differentiating Legendre's Equation m times, where m is a positive integer, we obtain

$$(1 - z^2) \frac{d^{m+2} w}{dz^{m+2}} - 2(m+1)z \frac{d^{m+1} w}{dz^{m+1}} + (n-m)(n+m+1) \frac{d^m w}{dz^m} = 0.$$

Accordingly, if m is a positive integer, two independent solutions of Legendre's Associated Equation are

$$P_n^m(z) = (z^2 - 1)^{\frac{m}{2}} \frac{d^m P_n(z)}{dz^m}, \quad Q_n^m(z) = (z^2 - 1)^{\frac{m}{2}} \frac{d^m Q_n(z)}{dz^m}.$$

These functions $P_n^m(z)$ and $Q_n^m(z)$ are known as *Legendre's Associated Functions of the First and Second Kinds* respectively. To make them uniform a cross-cut is taken along the real axis from $-\infty$ to $+1$, and that branch of $(z^2 - 1)^{\frac{m}{2}}$ is chosen which is real and positive when z is real and greater than 1.

If m and n are positive integers, and $m \leq n$,

$$\begin{aligned} P_n^m(z) &= \frac{1}{2^n \cdot n!} (z^2 - 1)^{\frac{1}{2}m} \frac{d^{n+m}}{dz^{n+m}} (z^2 - 1)^n, \quad (\S 54, \text{p. 120}) \\ &= \frac{1}{n!} (z^2 - 1)^{\frac{1}{2}m} \frac{d^{n+m}}{dz^{n+m}} \left\{ (z-1)^n \left(1 + \frac{z-1}{2}\right)^n \right\} \\ &= \frac{(n+m)!}{2^m \cdot m! (n-m)!} (z^2 - 1)^{\frac{1}{2}m} F\left(-n+m, n+m+1, m+1, \frac{1-z}{2}\right) \\ &= \frac{(n+m)!}{2^m \cdot m! (n-m)!} (z^2 - 1)^{\frac{1}{2}m} \left(\frac{1+z}{2}\right)^{-m} F\left(n+1, -n, m+1, \frac{1-z}{2}\right) \\ &\qquad\qquad\qquad (\S 93, \text{Form II. of } W_1^{(0)}) \\ &= \frac{(n+m)!}{m! (n-m)!} \left(\frac{z-1}{z+1}\right)^{\frac{1}{2}m} F\left(n+1, -n, m+1, \frac{1-z}{2}\right). \end{aligned}$$

If $m > n$, $P_n^m(z) = 0$.

Similarly, if m is a positive integer, then for all values of n ,

$$\begin{aligned} Q_n^m(z) &= \frac{(-1)^m (z^2 - 1)^{\frac{1}{2}m} \Gamma(n+m+1) \Gamma(\frac{1}{2})}{2^{n+1} \Gamma(n+3/2)} \frac{1}{z^{n+m+1}} \\ &\quad \times F\left(\frac{n+m+2}{2}, \frac{n+m+1}{2}, n + \frac{3}{2}, \frac{1}{z^2}\right). \end{aligned}$$

Again, let the equation

$$(1-z^2)\frac{d^2W}{dz^2} - 2(1-m)z\frac{dW}{dz} + (n+m)(n-m+1)W = 0,$$

obtained from Legendre's Associated Equation by means of the substitution

$$w = (z^2 - 1)^{-\frac{1}{2}m}W,$$

be differentiated m times; then

$$(1-z^2)\frac{d^{m+2}W}{dz^{m+2}} - 2z\frac{d^{m+1}W}{dz^{m+1}} + n(n+1)\frac{d^mW}{dz^m} = 0.$$

Hence, if m and n are positive integers, and if $m \leq n$, two independent solutions of Legendre's Associated Equation are

$$P_n^{-m}(z) = (z^2 - 1)^{-\frac{m}{2}} \int_1^z \int_1^z \dots \int_1^z P_n(z)(dz)^m,$$

and

$$Q_n^{-m}(z) = (z^2 - 1)^{-\frac{m}{2}} \int_\infty^z \int_\infty^z \dots \int_\infty^z Q_n(z)(dz)^m.$$

Since the four functions $P_n^m(z)$, $P_n^{-m}(z)$, $Q_n^m(z)$, $Q_n^{-m}(z)$, satisfy the same equation, they cannot all be independent. The relations connecting them are found as follows:

$$\begin{aligned} P_n^{-m}(z) &= \frac{1}{2^n \cdot n!} (z^2 - 1)^{-\frac{m}{2}} \frac{d^{n-m}}{dz^{n-m}} (z^2 - 1)^n \\ &= \frac{1}{m!} \left(\frac{z-1}{z+1}\right)^{\frac{m}{2}} F\left(-n, n+1, m+1, \frac{1-z}{2}\right) \\ &= \frac{(n-m)!}{(n+m)!} P_n^m(z). \end{aligned}$$

$$\begin{aligned} Q_n^{-m}(z) &= (-1)^m \frac{1}{2^{n+1}} (z^2 - 1)^{-\frac{m}{2}} \frac{\Gamma(n-m+1)\Gamma(\frac{1}{2})}{\Gamma(n+\frac{3}{2})} \frac{1}{z^{n-m+1}} \\ &\quad \times F\left(\frac{n-m+2}{2}, \frac{n-m+1}{2}, n+\frac{3}{2}, \frac{1}{z^2}\right) \\ &= (-1)^m \frac{1}{2^{n+1}} (z^2 - 1)^{-\frac{m}{2}} \frac{\Gamma(n-m+1)\Gamma(\frac{1}{2})}{\Gamma(n+\frac{3}{2})} \frac{1}{z^{n-m+1}} \left(1 - \frac{1}{z^2}\right)^m \\ &\quad \times F\left(\frac{n+m+1}{2}, \frac{n+m+2}{2}, n+\frac{3}{2}, \frac{1}{z^2}\right) \\ &= \frac{(n-m)!}{(n+m)!} Q_n^m(z). \end{aligned}$$

(§ 93, Form II. of $W_1^{(0)}$)

EXAMPLES XIV.

1. Show that, for all values of n :

$$(i) P'_n(z) - P'_{n-2}(z) = (2n-1)P_{n-1}(z);$$

$$(ii) P'_n(z) - zP'_{n-1}(z) = nP_{n-1}(z);$$

$$(iii) Q'_n(z) - Q'_{n-2}(z) = (2n-1)Q_{n-1}(z);$$

$$(iv) Q'_n(z) - zQ'_{n-1}(z) = nQ_{n-1}(z).$$

2. Show that

$$(i) Q_0(z) = \frac{1}{2} \log \left(\frac{z+1}{z-1} \right); \quad (ii) Q_1(z) = \frac{z}{2} \log \left(\frac{z+1}{z-1} \right) - 1.$$

[Use Ex. 1, § 90.]

3. If n is zero or a positive integer, show that positive circuits about $z=1$ and $z=-1$ decrease and increase $Q_n(z)$ respectively by $\pi i P_n(z)$. [Use Ex. 1, § 90.]

4. Use the formula of Example 1, § 90, to prove the formulae of Example 2, § 90, for positive integral values of n .

5. For all values of n , show that

$$(z^2-1)\{Q_n(z)P'_n(z) - P_n(z)Q'_n(z)\} = C,$$

where C is a constant. [Substitute $P_n(z)$ and $Q_n(z)$ for v in Legendre's equation, multiply the two equations so obtained by $Q_n(z)$ and $P_n(z)$ respectively, subtract, and integrate.]

6. If n is a positive integer, show that

$$Q_n(z) = P_n(z) \int_z^\infty \frac{dz}{(z^2-1)\{P_n(z)\}^2}.$$

7. If n is a positive integer, prove :

$$(i) n\{P_n(z)Q_{n-1}(z) - Q_n(z)P_{n-1}(z)\} = 1;$$

$$(ii) n(n+1)\{P_{n+1}(z)Q_{n-1}(z) - P_{n-1}(z)Q_{n+1}(z)\} = (2n+1)z.$$

8. Show that

$$(i) zJ_{n-1}(z) - nJ_n(z) = zJ'_n(z) = nJ_n(z) - zJ_{n+1}(z);$$

$$(ii) zG_{n-1}(z) - nG_n(z) = zG'_n(z) = nG_n(z) - zG_{n+1}(z).$$

9. Prove that

$$(i) z^2 J''_n(z) = (n^2 - n - z^2)J_n(z) + zJ_{n+1}(z);$$

$$(ii) z^2 G''_n(z) = (n^2 - n - z^2)G_n(z) + zG_{n+1}(z).$$

10. Show that: (i) $J_{\frac{1}{2}}(z) = \sqrt{\frac{2}{\pi z}} \sin z$; (ii) $J_{-\frac{1}{2}}(z) = \sqrt{\frac{2}{\pi z}} \cos z$.

Deduce that, when n is half an odd integer, $J_n(z)$ can be expressed in terms of elementary functions.

11. Show that :

$$(i) \frac{d}{dz} \{z^n J_n(z)\} = z^n J_{n-1}(z); \quad (ii) \frac{d}{dz} \{z^{-n} J_n(z)\} = -z^{-n} J_{n+1}(z);$$

$$(iii) \frac{d}{dz} \{z^n G_n(z)\} = z^n G_{n-1}(z); \quad (iv) \frac{d}{dz} \{z^{-n} G_n(z)\} = -z^{-n} G_{n+1}(z).$$

12. Shew that

$$(i) \quad 2^m \frac{d^m}{dz^m} J_n(z) = c_0 J_{n-m}(z) - c_1 J_{n-m+2}(z) + \dots + (-1)^m c_m J_{n+m}(z),$$

$$(ii) \quad 2^m \frac{d^m}{dz^m} G_n(z) = c_0 G_{n-m}(z) - c_1 G_{n-m+2}(z) + \dots + (-1)^m c_m G_{n+m}(z),$$

where c_0, c_1, \dots, c_m , are the coefficients in the expansion of $(1+x)^m$.

13. Establish the expansions :

$$(i) \quad \frac{z}{2} J_{n-1}(z) = n J_n(z) - (n+2) J_{n+2}(z) + (n+4) J_{n+4}(z) - \dots ;$$

$$(ii) \quad \frac{z}{2} J'_n(z) = \frac{n}{2} J_n(z) - (n+2) J_{n+2}(z) + (n+4) J_{n+4}(z) - \dots .$$

14. Shew that $J_n(z)$ is the coefficient of ξ^n in the expansion of $e^{\frac{1}{2}z(\zeta - \frac{1}{\zeta})}$ in powers of ξ .

15. Establish the expansions :

$$(i) \quad \cos(z \sin \theta) = J_0(z) + 2 \cos 2\theta J_2(z) + 2 \cos 4\theta J_4(z) + \dots ;$$

$$(ii) \quad \sin(z \sin \theta) = 2 \sin \theta J_1(z) + 2 \sin 3\theta J_3(z) + \dots .$$

[In Ex. 14 put $\xi = e^{\pm i\theta}$ in turn.]

16. If n is a positive integer, prove

$$J_n(z) = \frac{1}{\pi} \int_0^\pi \cos(n\theta - z \sin \theta) d\theta.$$

[Multiply expansions (i) and (ii) of Ex. 15 by $\cos n\theta$ and $\sin n\theta$, and add.]

17. Shew that

$$\{J_0(z)\}^2 + 2\{J_1(z)\}^2 + 2\{J_2(z)\}^2 + 2\{J_3(z)\}^2 + \dots = 1.$$

[Multiply together the expansions of $e^{\frac{1}{2}z(\zeta - \frac{1}{\zeta})}$ and $e^{-\frac{1}{2}z(\zeta - \frac{1}{\zeta})}$, and find the term independent of ξ .]

18. If $R(n) > -\frac{1}{2}$, shew that

$$z^n \int_0^\pi \cos(z \cos \phi) \sin^{2n} \phi d\phi = 2^n \Gamma(\frac{1}{2}) \Gamma(n + \frac{1}{2}) J_n(z).$$

[Expand $\cos(z \cos \phi)$ in powers of z , and evaluate the coefficients.]

19. Solve $zw'' + w = 0$.

$$Ans. \quad w_1 = z^{\frac{1}{2}} J_1(2\sqrt{z}), \quad w_2 = z^{\frac{1}{2}} G_1(2\sqrt{z}).$$

20. Solve $z^2 w'' - 2zw' + 4(z^2 - 1)w = 0$.

$$Ans. \quad w_1 = z^{\frac{3}{2}} J_{\frac{3}{4}}(z^2), \quad w_2 = z^{\frac{3}{2}} J_{-\frac{5}{4}}(z^2).$$

21. Solve $zw'' + (2n+1)w' + zw = 0$.

$$Ans. \quad w_1 = z^{-n} J_n(z), \quad w_2 = z^{-n} G_n(z).$$

22. If m, n, k , are positive integers, and $k < m, k < n$, shew that

$$(i) \quad \int_{-1}^1 P_m^k(z) P_n^k(z) dz = 0, \quad m \neq n ;$$

$$(ii) \quad \int_{-1}^1 \{P_n^k(z)\}^2 dz = (-1)^k \frac{(n+k)!}{(n-k)!} \frac{2}{2n+1} .$$

23. If n is an integer, shew that

$$J_n(u+v) = \sum_{m=-\infty}^{+\infty} J_m(u)J_{n-m}(v).$$

[Equate the coefficients of ξ^n in $e^{\frac{1}{2}(u+v)(\xi-\frac{1}{\xi})} = e^{\frac{1}{2}u(\xi-\frac{1}{\xi})}e^{\frac{1}{2}v(\xi-\frac{1}{\xi})}$.]

24. If n is an integer, shew that

$$G_n(u+v) = \sum_{m=-\infty}^{\infty} G_m(u)J_{n-m}(v).$$

25. Deduce Gauss's Theorem (§ 61) from the Example of § 93.

26. Shew that, if $\gamma - \alpha - \beta < 0$,

$$\text{Lim}_{z \rightarrow 1} \frac{F(\alpha, \beta, \gamma, z)}{(1-z)^{\gamma-\alpha-\beta}} = \frac{\Gamma(\alpha+\beta-\gamma)\Gamma(\gamma)}{\Gamma(\alpha)\Gamma(\beta)};$$

while if $\gamma - \alpha - \beta = 0$,

$$\text{Lim}_{z \rightarrow 1} \frac{F(\alpha, \beta, \gamma, z)}{\log(1-z)} = -\frac{\Gamma(\alpha+\beta)}{\Gamma(\alpha)\Gamma(\beta)}.$$

[For the second equation apply Ex. 4, § 63, to Form III. of $W_1^{(0)}$ (§ 93).]

27. Shew that, in the domain of the origin, every solution of Legendre's Associated Equation can be put in the form

$$c_1(z^2-1)^{\frac{1}{2}m}F\left(\frac{m-n}{2}, \frac{m+n+1}{2}, \frac{1}{2}, z^2\right) + c_2(z^2-1)^{\frac{1}{2}m}zF\left(\frac{m-n+1}{2}, \frac{m+n+2}{2}, \frac{3}{2}, z^2\right).$$

CHAPTER XV.

SOLUTION OF DIFFERENTIAL EQUATIONS BY DEFINITE INTEGRALS.

95. First Method of Solution.* If $Q(z)$ and $L(z)$ are quadratic and linear functions of z respectively, and K is a constant, the equation

$$Q(z)w'' + L(z)w' + Kw = 0$$

can be put in the form

$$\begin{aligned} Q(z)w'' - \lambda Q'(z)w' + \frac{\lambda(\lambda+1)}{2} Q''(z)w \\ - R(z)w' + (\lambda+1)R'(z)w = 0, \end{aligned} \quad (\text{A})$$

where $R(z)$ is linear in z . We shall confine ourselves to the case in which the factors of $Q(z)$ are distinct.

If the function $\int_c \phi(\xi)(\xi-z)^{\lambda+1} d\xi$ is substituted for w in equation (A), then

$$\int_c \phi(\xi) \left[\begin{aligned} &\lambda(\lambda+1)(\xi-z)^{\lambda-1} \left\{ Q(z) + (\xi-z)Q'(z) + \frac{(\xi-z)^2}{2!} Q''(z) \right\} \\ &+ (\lambda+1)(\xi-z)^\lambda \{ R(z) + (\xi-z)R'(z) \} \end{aligned} \right] d\xi = 0;$$

so that
$$\int_c \phi(\xi) \{ \lambda(\xi-z)^{\lambda-1} Q(\xi) + (\xi-z)^\lambda R(\xi) \} d\xi = 0. \quad (\text{B})$$

Accordingly, if $\phi(\xi)$ satisfies the equation

$$\phi(\xi)R(\xi) = \frac{d}{d\xi} \{ \phi(\xi)Q(\xi) \}, \quad (\text{C})$$

equation (B) becomes

$$\int_c \frac{d}{d\xi} \{ \phi(\xi)Q(\xi)(\xi-z)^\lambda \} d\xi = 0.$$

* Cf. Jordan, *Cours d'Analyse*, t. III, p. 240.

Now, equation (c) gives

$$\frac{d}{d\xi}\{\phi(\xi)Q(\xi)\} = \frac{R(\xi)}{Q(\xi)} = \frac{p}{\xi-a} + \frac{q}{\xi-b},$$

where p and q are constants, and $\xi-a$, $\xi-b$, are factors of $Q(\xi)$.

Thus $\phi(\xi)Q(\xi) = (\xi-a)^p(\xi-b)^q$;
so that $\phi(\xi) = D(\xi-a)^{p-1}(\xi-b)^{q-1}$,

where D is a constant.

Accordingly,

$$w = \int_C (\xi-a)^{p-1}(\xi-b)^{q-1}(\xi-z)^{\lambda+1} d\xi$$

is an integral, provided that either $(\xi-a)^p(\xi-b)^q(\xi-z)^\lambda$ vanishes at both extremities of C , or else C is a closed curve such that this function (or the integrand) has equal values at the initial and final points.

Let P be any point of the ξ -plane, and let A , B , and Z , denote loops drawn positively from P about a , b , and z . Also let \bar{A} , \bar{B} , \bar{Z} , denote the values of the integral

$$\int (\xi-a)^{p-1}(\xi-b)^{q-1}(\xi-z)^{\lambda+1} d\xi$$

taken round these loops, with M as the initial value, in each case, of the integrand at P . Any of the contours $ABA^{-1}B^{-1}$, $AZA^{-1}Z^{-1}$, $BZB^{-1}Z^{-1}$, where, for instance, the first denotes the loops A , B , A^{-1} , B^{-1} , described in succession, can be taken as path of integration C . For, if $ABA^{-1}B^{-1}$ be taken, the final value of the integrand is equal to its initial value multiplied by

$$e^{2\pi ip} e^{2\pi iq} e^{-2\pi ip} e^{-2\pi iq} = 1;$$

and similarly with the others.

Let the values of the integral taken round these three contours be denoted by $[AB]$, $[AZ]$, $[BZ]$, respectively. The value of $[AB]$ can be found as follows.

The loop A gives the integral \bar{A} , and brings the integrand back to P with the value $Me^{2\pi ip}$. Thus the loop B gives the integral $e^{2\pi ip}\bar{B}$, and the final value of the integrand is $e^{2\pi i(p+q)}M$. After describing the loop A^{-1} , the final value of the integrand is $e^{2\pi iq}M$, so that the corresponding integral is $-e^{2\pi iq}\bar{A}$; similarly the integral due to the loop B^{-1} is $-\bar{B}$. Thus

$$[AB] = (1 - e^{2\pi iq})\bar{A} - (1 - e^{2\pi ip})\bar{B}.$$

Similarly $[AZ] = (1 - e^{2\pi i \lambda})\bar{A} - (1 - e^{2\pi i \rho})\bar{Z}$;
 and $[BZ] = (1 - e^{2\pi i \lambda})\bar{B} - (1 - e^{2\pi i \rho})\bar{Z}$.

Hence $(1 - e^{2\pi i \lambda})[AB] + (1 - e^{2\pi i \rho})[BZ] + (1 - e^{2\pi i \rho})[ZA] = 0$;

so that a linear relation exists between the three integrals, as is to be expected. Any two of these integrals, say $[AZ]$ and $[BZ]$, can be taken as the fundamental system.

The Branch Points of the Integral. When z is fixed, the path of integration can be deformed without altering the value of the integral, provided that it is not made to pass over any of the points a, b, z . If z varies continuously, the integrals will also vary continuously, provided that the path of integration is

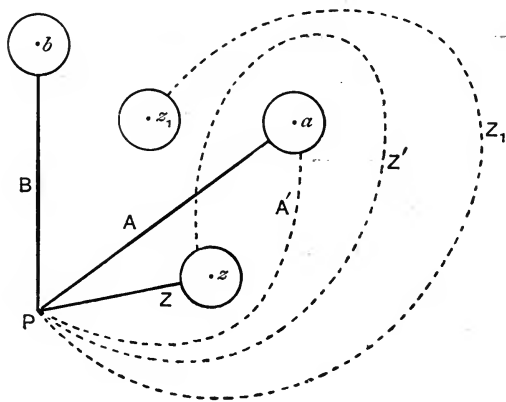

FIG. 76.

deformed, when necessary, so as to avoid passing through the points a, b, z .

If z describes a contour about a , the loops A and Z (Fig. 76) must be deformed into loops A' and Z' .*

Now Z' is equivalent to $ZAZA^{-1}Z^{-1}$ and A' to ZAZ^{-1} or $ZAZ^{-1}A^{-1}A$. Thus, if \bar{Z}' and \bar{A}' are the values of the integrals taken along Z' and A' ,

$$\bar{Z}' = \bar{Z} + e^{2\pi i \lambda}[AZ], \quad \bar{A}' = -[AZ] + \bar{A}.$$

* This can be effected as follows : (i) deform Z into Z_1 , so that z passes round a to z_1 ; (ii) deform A into A' ; (iii) deform Z_1 into Z' , so that z moves from z_1 into its original position.

Accordingly, $[AZ]$ is transformed into $[AZ]'$, where

$$\begin{aligned} [AZ]' &= (1 - e^{2\pi i \lambda}) \bar{A}' - (1 - e^{2\pi i p}) \bar{Z}' \\ &= (1 - e^{2\pi i \lambda}) \{-[AZ] + \bar{A}\} - (1 - e^{2\pi i p}) \{\bar{Z} + e^{2\pi i \lambda} [AZ]\} \\ &= e^{2\pi i (p + \lambda)} [AZ]. \end{aligned} \quad (D)$$

Similarly $[BZ]$ becomes $[BZ]'$, where

$$[BZ]' = [BZ] + (e^{2\pi i q} - 1) e^{2\pi i \lambda} [AZ].$$

Thus a is a branch point of both integrals. Similarly it can be shewn that b is a branch point. Infinity is also, in general, a branch point; but a circuit about it can always be replaced by circuits about a and b .

96. Gauss's Equation. If in equation (A), § 95,

$$Q(z) = z - z^2, \quad R(z) = (\alpha - \gamma + 1) - (\alpha - \beta + 1)z, \quad \lambda = -\alpha - 1,$$

then $a = 0, \quad b = 1, \quad p = \alpha - \gamma + 1, \quad q = \gamma - \beta;$

thus the equation becomes Gauss's Equation,

$$z(1-z)w'' + \{\gamma - (\alpha + \beta + 1)z\}w' - \alpha\beta w = 0,$$

and has the integral

$$\int_C \xi^{\alpha-\gamma} (\xi-1)^{\gamma-\beta-1} (\xi-z)^{-\alpha} d\xi,$$

where C is so chosen that the initial and final values of the integrand are identical.

A second integral can be obtained by interchanging α and β , and a third by putting $1/\xi$ for ξ . The latter integral is

$$\int_C \xi^{\beta-1} (1-\xi)^{\gamma-\beta-1} (1-z\xi)^{-\alpha} d\xi.$$

Employing the notation of § 62, we can write one such integral,

$$\int^{(1+, 0+, 1-, 0-)} \xi^{\beta-1} (1-\xi)^{\gamma-\beta-1} (1-z\xi)^{-\alpha} d\xi,$$

where the initial point lies on the real axis between 0 and 1, and the initial values of $\xi^{\beta-1}$ and $(1-\xi)^{\gamma-\beta-1}$ are real and positive. If z describes a closed contour enclosing $z=0$ but not $z=1$, the singular point $1/z$ will describe a closed contour enclosing $z=0$ and $z=1$; and therefore the contour of the integral need not be altered. Accordingly, for values of z which lie in a simply-connected region enclosing $z=0$, but not enclosing $z=1$, the integral is a uniform function of z .

Now let $|z\xi| < 1$, and choose that value of $(1 - z\xi)^{-\alpha}$ which has the value +1 when $z=0$; then

$$\begin{aligned} & \int^{(1+, 0+, 1-, 0-)} \xi^{\beta-1} (1-\xi)^{\gamma-\beta-1} (1-z\xi)^{-\alpha} d\xi \\ &= \sum_{n=0}^{\infty} \frac{\alpha(\alpha+1)\dots(\alpha+n-1)}{n!} \int^{(1+, 0+, 1-, 0-)} \xi^{\beta+n-1} (1-\xi)^{\gamma-\beta-1} d\xi z^n \\ &= \sum_{n=0}^{\infty} \frac{\alpha(\alpha+1)\dots(\alpha+n-1)}{n!} (1 - e^{2\pi i\beta}) \{1 - e^{2\pi i(\gamma-\beta)}\} \\ & \quad \times B(\beta+n, \gamma-\beta) z^n, \quad (\S 62) \\ &= (1 - e^{2\pi i\beta}) \{1 - e^{2\pi i(\gamma-\beta)}\} B(\beta, \gamma-\beta) F(\alpha, \beta, \gamma, z). \end{aligned}$$

Note. The expression given by this equation for the function $F(\alpha, \beta, \gamma, z)$ as a contour integral is valid for all values of z .

Example. Prove $F(\alpha, \beta, \gamma, z) = (1-z)^{-\alpha} F\left(\alpha, \gamma-\beta, \gamma, \frac{z}{z-1}\right)$.
[Put $\xi = 1 - \xi'$.]

Again, consider the integral

$$\int^{(0+, z+, 0-, z-)} \xi^{\alpha-\gamma} (1-\xi)^{\gamma-\beta-1} (z-\xi)^{-\alpha} d\xi,$$

where the initial point is on the straight line joining $\xi=0$ to $\xi=z$, and the amplitudes of ξ/z and $(1-\xi/z)$ are taken to be zero at this point; while that branch of $(1-\xi)^{\gamma-\beta-1}$ is taken which has the value 1 when $\xi=0$. From formula (D) of § 95 it follows that when z describes a closed contour about $z=0$, the integral is multiplied by $e^{-2\pi i\gamma}$.

Now let $\xi = zZ$; then the integral becomes

$$\begin{aligned} & z^{1-\gamma} \int^{(0+, 1+, 0-, 1-)} Z^{\alpha-\gamma} (1-Z)^{-\alpha} (1-zZ)^{\gamma-\beta-1} dZ \\ &= -\{1 - e^{2\pi i(\alpha-\gamma)}\} (1 - e^{-2\pi i\alpha}) B(\alpha-\gamma+1, 1-\alpha) \\ & \quad \times z^{1-\gamma} F(\beta-\gamma+1, \alpha-\gamma+1, 2-\gamma, z). \end{aligned}$$

This equation gives an expression for the function

$$z^{1-\gamma} F(\alpha-\gamma+1, \beta-\gamma+1, 2-\gamma, z),$$

which is valid for all values of z .

97. Legendre's Associated Equation.* If in equation (A), § 95,

$$Q(z) = 1 - z^2, \quad R(z) = -2(n+1)z, \quad \lambda = -n - m - 2,$$

then

$$a = -1, \quad b = 1, \quad p = q = n + 1;$$

* Cf. Hobson, *Phil. Trans.*, Vol. 187.

thus the equation becomes

$$(1-z^2)w'' - 2(m+1)zw' + (n-m)(n+m+1)w = 0,$$

and has the integral

$$\int_C (\xi^2-1)^n (\xi-z)^{-n-m-1} d\xi,$$

where C is a suitable contour of integration. Hence (§ 94)

$$w = (z^2-1)^{\frac{1}{2}m} \int_0 (\xi^2-1)^n (\xi-z)^{-n-m-1} d\xi$$

is an integral of Legendre's Associated Equation.

The Function $P_n^m(z)$. Consider the function

$$w = (z^2-1)^{\frac{1}{2}m} \int^{(z+, 1+, z-, 1-)} (\xi^2-1)^n (\xi-z)^{-n-m-1} d\xi,$$

where a cross-cut is taken along the real axis in the z -plane from 1 to $-\infty$ to make the function uniform in z , and the amplitudes of $z-1$ and $z+1$ lie between $-\pi$ and $+\pi$. Let A (Fig. 77), a point in the ξ -plane on the straight line joining $\xi=1$ to $\xi=z$, be taken as initial point; and let the initial amplitudes of $\xi-1$ and $\xi+1$ be ϕ and ϕ' , where these are the angles (between $\pm\pi$)

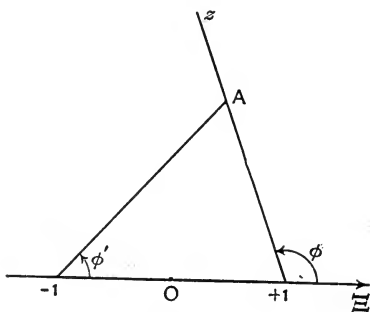

FIG. 77.

which the lines joining $\xi=1$ and $\xi=-1$ to A make with the positive ξ -axis. Also let the initial value of $\text{amp}(\xi-z)$ be $-(\pi-\phi)$, so that $\text{amp}(\xi-z)$ is zero for points on the contour at which $\xi-z$ is a positive real quantity. Thus if z lies on the x -axis to the right of $+1$, the initial values of $\text{amp}(\xi+1)$, $\text{amp}(\xi-1)$, and $\text{amp}(\xi-z)$ are 0, 0, and $-\pi$, respectively.

Now let $\xi - 1 = (z - 1)Z$; then the initial value of $\text{amp } Z$ is zero. Again $\xi + 1 = 2\left(1 + \frac{z-1}{2}Z\right)$. But when $\xi = 1$, $\text{amp}(\xi + 1) = 0$;

hence $\text{amp}\left(1 + \frac{z-1}{2}Z\right)$ is zero when $Z = 0$. Also

$$\xi - z = -(z - 1)(1 - Z) = e^{-i\pi}(z - 1)(1 - Z),$$

where $\text{amp}(1 - Z)$ is initially zero. Thus

$$\begin{aligned} w &= \left(\frac{z+1}{z-1}\right)^{\frac{1}{2}m} 2^n e^{i\pi(n+m+1)} \\ &\quad \times \int^{(1+, 0+, 1-, 0-)} Z^n (1-Z)^{-n-m-1} \left(1 + \frac{z-1}{2}Z\right)^n dZ \\ &= \left(\frac{z+1}{z-1}\right)^{\frac{1}{2}m} 2^n e^{i\pi(n+m+1)} \sum_{r=0}^{\infty} \frac{n(n-1)\dots(n-r+1)}{r!} \\ &\quad \times \left(\frac{z-1}{2}\right)^r \int^{(1+, 0+, 1-, 0-)} Z^{n+r} (1-Z)^{-n-m-1} dZ \\ &= \left(\frac{z+1}{z-1}\right)^{\frac{1}{2}m} 2^n e^{i\pi(n+m+1)} \sum_{r=0}^{\infty} \frac{n(n-1)\dots(n-r+1)}{r!} \\ &\quad \times \left(\frac{z-1}{2}\right)^r (1 - e^{2\pi i n}) \{1 - e^{-2\pi i(n+m)}\} B(n+r+1, -n-m) \\ &= \left(\frac{z+1}{z-1}\right)^{\frac{1}{2}m} 2^{n+2} \pi e^{\pi i n} \sin n\pi \frac{\Gamma(n+1)}{\Gamma(n+m+1)\Gamma(1-m)} \\ &\quad \times F\left(-n, n+1, 1-m, \frac{1-z}{2}\right). \end{aligned}$$

In particular, if $m = 0$,

$$\begin{aligned} &\int^{(z+, 1+, z-, 1-)} (\xi^2 - 1)^n (\xi - z)^{-n-1} d\xi = 2^{n+2} \pi e^{\pi i n} \sin n\pi \\ &\quad \times F\left(-n, n+1, 1, \frac{1-z}{2}\right); \end{aligned}$$

so that (§ 90)

$$P_n(z) = \frac{e^{-\pi i n}}{2^n 4\pi \sin n\pi} \int^{(z+, 1+, z-, 1-)} (\xi^2 - 1)^n (\xi - z)^{-n-1} d\xi.$$

Now, if m is a positive integer, then (§ 94)

$$\begin{aligned} P_n^m(z) &= (z^2 - 1)^{\frac{1}{2}m} \frac{d^m P_n(z)}{dz^m} \\ &= \frac{e^{-\pi i n}}{2^n 4\pi \sin n\pi} \frac{\Gamma(n+m+1)}{\Gamma(n+1)} (z^2 - 1)^{\frac{1}{2}m} \\ &\quad \times \int^{(z+, 1+, z-, 1-)} (\xi^2 - 1)^n (\xi - z)^{-n-m-1} d\xi \\ &= \frac{1}{\Gamma(1-m)} \left(\frac{z+1}{z-1}\right)^{\frac{1}{2}m} F\left(-n, n+1, 1-m, \frac{1-z}{2}\right). \end{aligned}$$

But this function satisfies the differential equation for all values of m . Hence, for all values of n and m , $P_n^m(z)$ can be defined by any one of the equations

$$\begin{aligned} P_n^m(z) &= \frac{1}{\Gamma(1-m)} \left(\frac{z+1}{z-1}\right)^{\frac{1}{2}m} F\left(-n, n+1, 1-m, \frac{1-z}{2}\right) \\ &= \frac{2^m}{\Gamma(1-m)} (z^2-1)^{-\frac{1}{2}m} F\left(-m-n, n-m+1, 1-m, \frac{1-z}{2}\right) \quad (\S 93) \\ &= \frac{\Pi(n+m)}{\Pi(n)} \frac{2^{-n} e^{-\pi i n}}{4\pi \sin n\pi} (z^2-1)^{\frac{1}{2}m} \int^{(z+, 1+, z-, 1-)} (\xi^2-1)^n (\xi-z)^{-n-m-1} d\xi. \end{aligned}$$

COROLLARY. $P_{-n-1}^m(z) = P_n^m(z)$.

Example 1. Shew that

$$\int^{(z+, 1+, z-, 1-)} (\xi^2-1)^n (\xi-z)^{-n-1} d\xi = (1-e^{2\pi i n}) \int^{(z+, 1+)} (\xi^2-1)^n (\xi-z)^{-n-1} d\xi;$$

deduce that $P_n(z) = \frac{1}{2\pi i} \frac{1}{2^n} \int^{(z+, 1+)} (\xi^2-1)^n (\xi-z)^{-n-1} d\xi$.

The Function $Q_n^m(z)$. Again, consider the function

$$w = (z^2-1)^{\frac{1}{2}m} \int^{(-1+, +1-)} (\xi^2-1)^n (\xi-z)^{-n-m-1} d\xi,$$

where a cross-cut is taken along the real axis in the z -plane from 1 to $-\infty$ to make the function uniform in z . Let the origin in the ξ -plane be taken as initial point; and let $\xi+1$ and $\xi-1$ have initial amplitudes -2π and π respectively, so that they will both have amplitude zero when ξ is real and greater than 1. Also let the initial value of $\text{amp}(\xi-z)$ be $\text{amp} z - \pi$.

Then, if $|z| > 1$,

$$\begin{aligned} w &= e^{i\pi(n+m+1)} (z^2-1)^{\frac{1}{2}m} \\ &\times \sum_{\nu=0}^{\infty} \frac{\Gamma(n+m+\nu+1)}{\Gamma(\nu+1)\Gamma(n+m+1)} \frac{1}{z^{n+m+\nu+1}} \int^{(-1+, +1-)} \xi^{\nu} (\xi^2-1)^n d\xi \\ &= e^{i\pi(n+m+1)} (z^2-1)^{\frac{1}{2}m} 2i \sin n\pi \\ &\times \sum_{r=0}^{\infty} \frac{\Gamma(n+m+2r+1)}{\Gamma(2r+1)\Gamma(n+m+1)} \frac{\Gamma(n+1)\Gamma\left(\frac{2r+1}{2}\right)}{\Gamma\left(n+\frac{2r+3}{2}\right)} \frac{1}{z^{n+m+2r+1}}, \quad (\text{Exs. VIII. 7}) \\ &= e^{i\pi(n+m+1)} 2i \sin(n\pi) (z^2-1)^{\frac{1}{2}m} \frac{1}{z^{n+m+1}} \frac{\Gamma(n+1)\Gamma\left(\frac{1}{2}\right)}{\Gamma\left(n+\frac{3}{2}\right)} \\ &\times F\left(\frac{n+m+2}{2}, \frac{n+m+1}{2}, n+\frac{3}{2}, \frac{1}{z^2}\right), \quad (\S 62, \text{Ex. 2}). \end{aligned}$$

Now, if m is a positive integer (§ 94),

$$Q_n^m(z) = \frac{(-1)^m (z^2 - 1)^{\frac{1}{2}m}}{2^{n+1}} \frac{\Gamma(n+m+1)\Gamma(\frac{1}{2})}{\Gamma(n+\frac{3}{2})} \frac{1}{z^{n+m+1}} \\ \times F\left(\frac{n+m+2}{2}, \frac{n+m+1}{2}, n+\frac{3}{2}, \frac{1}{z^2}\right).$$

But we have just shewn that this function satisfies the equation for all values of n and m . Hence, for all values of n and m , $Q_n^m(z)$ can be defined by either of the equations

$$Q_n^m(z) = \frac{e^{m\pi i}}{2^{n+1}} \frac{\Gamma(n+m+1)\Gamma(\frac{1}{2})}{\Gamma(n+\frac{3}{2})} \frac{(z^2-1)^{\frac{1}{2}m}}{z^{n+m+1}} \\ \times F\left(\frac{n+m+2}{2}, \frac{n+m+1}{2}, n+\frac{3}{2}, \frac{1}{z^2}\right) \\ = \frac{e^{-i\pi(n+1)}}{2^{n+1}} \frac{1}{2i \sin n\pi} \frac{\Gamma(n+m+1)}{\Gamma(n+1)} (z^2-1)^{\frac{1}{2}m} \\ \times \int^{(-1+, +1-)} (\xi^2-1)^n (\xi-z)^{-n-m-1} d\xi.$$

COROLLARY. By applying the formula (§ 93)

$$F(\alpha, \beta, \gamma, \xi) = (1-\xi)^{\gamma-\alpha-\beta} F(\gamma-\alpha, \gamma-\beta, \gamma, \xi),$$

we obtain the relation

$$\frac{e^{-m\pi i} Q_n^m(z)}{\Gamma(n+m+1)} = \frac{e^{m\pi i} Q_n^{-m}(z)}{\Gamma(n-m+1)}.$$

A Second Expansion for $Q_n^m(z)$. Consider the function

$$(z^2-1)^{\frac{1}{2}m} \int^{(z+, -1+, z-, -1-)} (\xi^2-1)^n (\xi-z)^{-n-m-1} d\xi.$$

There are two cases to consider, according as $I(z)$ is positive or negative.

Let A (Fig. 78), the initial point, be on the straight line joining $\xi = -1$ to $\xi = z$, and let this line make an angle ϕ with the positive ξ -axis. Also let the initial values of $\text{amp}(\xi+1)$ and $\text{amp}(\xi-z)$ be ϕ and $-(\pi-\phi)$ respectively. Then if $\xi+1 = (z+1)Z$, the initial value of $\text{amp} Z$ is zero. Also $\xi-z = (z+1)(Z-1)$, so that the initial value of $\text{amp}(Z-1)$ is $-\pi$. Again, since $\xi-1 = -2\left(1-\frac{1+z}{2}Z\right)$, and since, when $\xi = -1$, $\text{amp}(\xi-1)$ has the value π in the first case, and the value $-\pi$

in the second case, $\xi - 1$ has the value $2e^{i\pi}\left(1 - \frac{1+z}{2}Z\right)$ when $I(z)$ is positive, and the value $2e^{-i\pi}\left(1 - \frac{1+z}{2}Z\right)$ when $I(z)$ is negative.

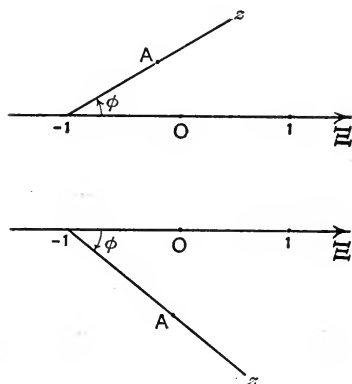

FIG. 78.

Hence the given function has the value

$$\begin{aligned}
 & e^{\pm n\pi i} \left(\frac{z-1}{z+1}\right)^{\frac{1}{2}m} 2^n e^{i\pi(n+m+1)} \\
 & \quad \times \int^{(1+, 0+, 1-, 0-)} Z^n (1-Z)^{-n-m-1} \left(1 - \frac{1+z}{2}Z\right)^n dZ \\
 & = e^{n\pi i \pm n\pi i} 2^n 4\pi \sin n\pi \frac{\Gamma(n+1)}{\Gamma(n+m+1)\Gamma(1-m)} \left(\frac{z-1}{z+1}\right)^{\frac{1}{2}m} \\
 & \quad \times F\left(-n, n+1, 1-m, \frac{1+z}{2}\right), \quad (\S 96),
 \end{aligned}$$

according as $I(z)$ is positive or negative.

Now let L, M, N , be the values of $\int (\xi^2 - 1)^n (\xi - z)^{-n-m-1} d\xi$ taken round loops from $\xi = 0$ about $-1, 1, z$, respectively; the initial value of $\text{amp}(\xi - 1)$ will be π or $-\pi$ according as $I(z)$ is positive or negative. Then (§ 95):

$$\begin{aligned}
 & \int^{(z+, 1+, z-, 1-)} (\xi^2 - 1)^n (\xi - z)^{-n-m-1} d\xi \\
 & \quad = N(1 - e^{2n\pi i}) - M\{1 - e^{-2(m+n+1)\pi i}\}; \\
 & \int^{(z+, -1+, z-, -1-)} (\xi^2 - 1)^n (\xi - z)^{-n-m-1} d\xi \\
 & \quad = N(1 - e^{2n\pi i}) - L\{1 - e^{-2(m+n+1)\pi i}\}; \\
 & \int^{(-1+, +1-)} (\xi^2 - 1)^n (\xi - z)^{-n-m-1} d\xi = L - M.
 \end{aligned}$$

Denote the integral in the last equation by W_1 ; the initial value of $\text{amp}(\xi^2-1)^n$ in this integral is $\pm n\pi i$, according as $I(z)$ is positive or negative. Again, let W_2 denote the integral $\int^{(-1+, +1-)} (\xi^2-1)^n (\xi-z)^{-n-m-1} d\xi$, in which the initial values of $\text{amp}(\xi+1)$ and $\text{amp}(\xi-1)$ are -2π and π respectively; then $\text{amp}(\xi^2-1)^n$ is $-n\pi$ initially. Hence

$$e^{n\pi i} W_2 = e^{\mp n\pi i} W_1;$$

so that

$$W_2 = e^{-n\pi i \mp n\pi i} (L-M),$$

according as $I(z)$ is positive or negative.

But

$$(L-M) \{1 - e^{-2\pi(m+n)i}\} = \int^{(z+, 1+, z-, 1-)} (\xi^2-1)^n (\xi-z)^{-n-m-1} d\xi \\ - \int^{(z+, -1+, z-, -1-)} (\xi^2-1)^n (\xi-z)^{-n-m-1} d\xi.$$

Hence, since

$$Q_n^m(z) = \frac{e^{-i\pi(n+1)}}{2^{n+1}} \frac{1}{2i \sin n\pi} \frac{\Gamma(n+m+1)}{\Gamma(n+1)} (z^2-1)^{\frac{1}{2}m} W_2,$$

it follows that

$$Q_n^m(z) = \frac{\pi e^{m\pi i}}{2 \sin(m+n)\pi} \frac{1}{\Gamma(1-m)} \\ \times \left\{ \begin{array}{l} e^{\mp n\pi i} \left(\frac{z+1}{z-1}\right)^{\frac{1}{2}m} F\left(-n, n+1, 1-m, \frac{1-z}{2}\right) \\ - \left(\frac{z-1}{z+1}\right)^{\frac{1}{2}m} F\left(-n, n+1, 1-m, \frac{1+z}{2}\right) \end{array} \right\},$$

according as $I(z)$ is positive or negative.

COROLLARY. From the equation

$$Q_n^m(z) = e^{2m\pi i} \frac{\Gamma(n+m+1)}{\Gamma(n-m+1)} Q_n^{-m}(z), \quad (\text{cf. p. 263})$$

it follows that

$$Q_n^m(z) = \frac{\pi e^{m\pi i}}{2 \sin(n-m)\pi} \frac{\Gamma(n+m+1)}{\Gamma(n-m+1)} \frac{1}{\Gamma(1+m)} \\ \times \left\{ \begin{array}{l} e^{\mp n\pi i} \left(\frac{z-1}{z+1}\right)^{\frac{1}{2}m} F\left(-n, n+1, 1+m, \frac{1-z}{2}\right) \\ - \left(\frac{z+1}{z-1}\right)^{\frac{1}{2}m} F\left(-n, n+1, 1+m, \frac{1+z}{2}\right) \end{array} \right\}.$$

Example 2. Shew that

$$P_n^m(z) = \frac{e^{-m\pi i}}{\pi \cos n\pi} \{Q_n^m(z) \sin(m+n)\pi - Q_{n-1}^m(z) \sin(n-m)\pi\}.$$

98. Second Method of Solution. Differential equations of the type

$$(az + a')w'' + (bz + b')w' + (cz + c')w = 0 \quad (\text{A})$$

can be integrated as follows:

Substitute $w = \int_C \phi(\xi) e^{sz} d\xi$ in equation (A); then

$$\int_C \phi(\xi) e^{sz} \{(a\xi^2 + b\xi + c)z + (a'\xi^2 + b'\xi + c')\} d\xi = 0. \quad (\text{B})$$

Hence, if $\phi(\xi)$ satisfies the equation

$$(a'\xi^2 + b'\xi + c')\phi(\xi) = \frac{d}{d\xi} \{(a\xi^2 + b\xi + c)\phi(\xi)\}, \quad (\text{C})$$

equation (B) becomes $\int_C \frac{d}{d\xi} \theta(\xi) d\xi = 0$,

where $\theta(\xi) = \phi(\xi) e^{sz} (a\xi^2 + b\xi + c)$. Also equation (C) gives

$$\phi(\xi) = \frac{1}{a\xi^2 + b\xi + c} e^{\int \frac{a'\xi^2 + b'\xi + c'}{a\xi^2 + b\xi + c} d\xi}.$$

Thus $\int_C \phi(\xi) e^{sz} d\xi$ is a solution of equation (A), provided C is so chosen that $\theta(z)$ regains its initial value at the final point.

99. Bessel's Equation. In Bessel's Equation (§ 91) put $w = z^n W$; then

$$z \frac{d^2 W}{dz^2} + (2n + 1) \frac{dW}{dz} + zW = 0.$$

This is an equation of the type considered in the previous section. Accordingly, since, in this case,

$$\phi(\xi) = \frac{1}{\xi^2 + 1} e^{\int \frac{(2n+1)\xi}{\xi^2+1} d\xi} = (\xi^2 + 1)^{n-\frac{1}{2}},$$

$$W = \int_C e^{sz} (\xi^2 + 1)^{n-\frac{1}{2}} d\xi$$

is an integral, provided $\theta(z)$ or $e^{sz} (\xi^2 + 1)^{n-\frac{1}{2}}$ regains its initial value at the final point.

Hence, if ξ is replaced by $i\xi$, a solution of Bessel's Equation is

$$w = z^n \int_C e^{isz} (\xi^2 - 1)^{n-\frac{1}{2}} d\xi,$$

where C is a suitable contour.

Expression for $J_n(z)$. Consider the integral

$$\int^{(-1+, +1-)} e^{iz\xi} (\xi^2 - 1)^{n-\frac{1}{2}} d\xi,$$

where the initial point lies on the ξ -axis between -1 and $+1$. Let the initial amplitudes of $\xi+1$ and $\xi-1$ be -2π and π respectively, so that each of them has zero amplitude at the point where ξ crosses the ξ -axis to the right of $\xi=1$. Then

$$\begin{aligned} \int^{(-1+, +1-)} e^{iz\xi} (\xi^2 - 1)^{n-\frac{1}{2}} d\xi &= \sum_{\nu=0}^{\infty} \frac{(iz)^\nu}{\nu!} \int^{(-1+, +1-)} \xi^\nu (\xi^2 - 1)^{n-\frac{1}{2}} d\xi \\ &= -2i \cos n\pi \Gamma(n + \frac{1}{2}) \sum_{r=0}^{\infty} (-1)^r \frac{z^{2r}}{\Gamma(2r+1) \Gamma(n+r+1)} \Gamma\left(\frac{2r+1}{2}\right) \\ &\quad \text{(Exs. VIII. 7)} \\ &= -2i \cos n\pi \sqrt{\pi} \Gamma(n + \frac{1}{2}) \left(\frac{z}{2}\right)^n J_n(z), \quad (\S 62, \text{Ex. 2}) \\ &= -\frac{2i\pi \Gamma(\frac{1}{2})}{\Gamma(\frac{1}{2}-n)} \left(\frac{z}{2}\right)^n J_n(z). \end{aligned}$$

Hence

$$J_n(z) = \frac{i}{2\pi} \frac{\Gamma(\frac{1}{2}-n)}{\Gamma(\frac{1}{2})} \left(\frac{z}{2}\right)^n \int^{(-1+, +1-)} e^{iz\xi} (\xi^2 - 1)^{n-\frac{1}{2}} d\xi.$$

COROLLARY. If $R(n + \frac{1}{2}) > 0$,

$$\begin{aligned} J_n(z) &= \frac{1}{\Gamma(\frac{1}{2})\Gamma(n + \frac{1}{2})} \left(\frac{z}{2}\right)^n \int_{-1}^1 e^{iz\xi} (1 - \xi^2)^{n-\frac{1}{2}} d\xi \\ &= \frac{1}{\Gamma(\frac{1}{2})\Gamma(n + \frac{1}{2})} \left(\frac{z}{2}\right)^n \int_0^\pi e^{iz \cos \phi} \sin^{2n} \phi d\phi. \end{aligned}$$

Example. Prove

$$J_n(z) = \frac{i}{2\pi} \frac{\Gamma(\frac{1}{2}-n)}{\Gamma(\frac{1}{2})} \left(\frac{z}{2}\right)^n \int^{(-1+, +1-)} e^{-iz\xi} (\xi^2 - 1)^{n-\frac{1}{2}} d\xi.$$

Expression for $G_n(z)$. There are two cases to be considered.

CASE I. Let $-\pi/2 \leq \phi \leq \pi/2$, where $\phi = \text{amp } z$.

Then consider the integral

$$\int_C e^{iz\xi} (\xi^2 - 1)^{n-\frac{1}{2}} d\xi,$$

taken along the contour C of Fig. 79 from infinity back to infinity. Both extremities of C approach infinity in a direction making an angle $\pi/2 - \phi$ with the positive ξ -axis; so that $iz\xi$ is real and negative, and therefore $\theta(\xi)$ tends to zero at both

extremities. The amplitudes of $\xi+1$ and $\xi-1$ are chosen so that they vanish at the point L, where the curve crosses the positive ξ -axis.

If necessary, deform the path so that, at every point on it, $|\xi| > 1$; then

$$\int_C e^{iz\xi} (\xi^2 - 1)^{n-\frac{1}{2}} d\xi = \sum_{\nu=0}^{\infty} (-1)^\nu \frac{\Gamma(n+\frac{1}{2})}{\Gamma(\nu+1)\Gamma(n+\frac{1}{2}-\nu)} \int_C e^{iz\xi} \xi^{2n-2\nu-1} d\xi.$$

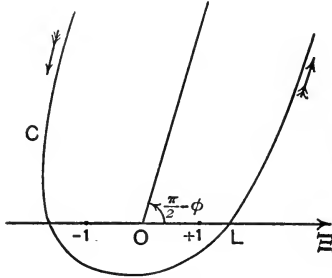

FIG. 79.

Now put $\lambda = e^{\frac{1}{2}\pi i} z\xi$, so that the initial and final values of $\arg \lambda$ are 0 and 2π respectively; then if

$$w = z^n \int_C e^{iz\xi} (\xi^2 - 1)^{n-\frac{1}{2}} d\xi,$$

$$w = z^{-n} \Gamma(n+\frac{1}{2}) e^{-3n\pi i} \sum_{\nu=0}^{\infty} \frac{z^{2\nu}}{\Gamma(\nu+1)\Gamma(n+\frac{1}{2}-\nu)} \int e^{-\lambda} \lambda^{2n-2\nu-1} d\lambda,$$

where the integral is taken along the contour of Fig. 60 (§ 61). Hence

$$\begin{aligned} w &= z^{-n} \Gamma(n+\frac{1}{2}) e^{-3n\pi i} \\ &\quad \times \sum_{\nu=0}^{\infty} \frac{e^{2\pi(n-\nu)i} 2i \sin 2(n-\nu)\pi}{\Gamma(\nu+1)\Gamma(n+\frac{1}{2}-\nu)} \Gamma(2n-2\nu) z^{2\nu} \\ &= z^{-n} \frac{\pi}{\Gamma(\frac{1}{2}-n) \cos n\pi} e^{-n\pi i} 2i \sin 2n\pi \\ &\quad \times \sum_{\nu=0}^{\infty} \frac{z^{2\nu}}{\Gamma(\nu+1)} \frac{2^{2n-2\nu-1}}{\sqrt{\pi}} \frac{\Gamma(n-\nu)\Gamma(n-\nu+\frac{1}{2})}{\Gamma(n-\nu+\frac{1}{2})}, \\ &\quad (\S 62, \text{Ex. } 2) \\ &= 2^n \frac{2\pi i e^{-n\pi i}}{\Gamma(\frac{1}{2}-n)} \Gamma(\frac{1}{2}) J_{-n}(z). \end{aligned}$$

$$\text{Thus } J_{-n}(z) = \frac{e^{n\pi i}}{2\pi i} \frac{\Gamma(\frac{1}{2}-n)}{\Gamma(\frac{1}{2})} \left(\frac{z}{2}\right)^n \int_C e^{iz\xi} (\xi^2 - 1)^{n-\frac{1}{2}} d\xi.$$

Next, let $R(n + \frac{1}{2}) > 0$, and $-\pi/2 < \phi \leq \pi/2$; then, deforming the path C into a contour (Fig. 80) consisting of a line through

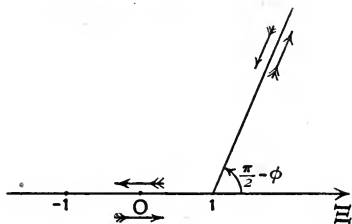

FIG. 80.

$\xi = 1$, which makes an angle $\pi/2 - \phi$ with the positive ξ -axis, described from ∞ to 1, the ξ -axis from 1 to -1 , and this path reversed, we have

$$\begin{aligned}
 J_{-n}(z) = & \{ -e^{-3i(n-\frac{1}{2})\pi} + e^{-i(n-\frac{1}{2})\pi} \} \\
 & \times \frac{e^{n\pi i}}{2\pi i} \frac{\Gamma(\frac{1}{2}-n)}{\Gamma(\frac{1}{2})} \left(\frac{z}{2}\right)^n \int_{-1}^1 e^{iz\xi} (1-\xi^2)^{n-\frac{1}{2}} d\xi \\
 & + \{ -1 + e^{4(n-\frac{1}{2})\pi i} \} \\
 & \times \frac{e^{n\pi i}}{2\pi i} \frac{\Gamma(\frac{1}{2}-n)}{\Gamma(\frac{1}{2})} \left(\frac{z}{2}\right)^n \int_1^\infty e^{iz\xi} (\xi^2-1)^{n-\frac{1}{2}} d\xi,
 \end{aligned}$$

where in the latter integral $\xi - 1$ and $\xi + 1$ have the amplitudes corresponding to the first description of the line from ∞ to 1. Hence

$$\begin{aligned}
 J_{-n}(z) = & e^{-n\pi i} J_n(z) + \frac{1}{\pi} e^{3n\pi i} \sin 2n\pi \frac{\Gamma(\frac{1}{2}-n)}{\Gamma(\frac{1}{2})} \\
 & \times \left(\frac{z}{2}\right)^n \int_1^\infty e^{iz\xi} (\xi^2-1)^{n-\frac{1}{2}} d\xi;
 \end{aligned}$$

so that

$$\begin{aligned}
 G_n(z) = & e^{3n\pi i} \cos n\pi \frac{\Gamma(\frac{1}{2}-n)}{\Gamma(\frac{1}{2})} \left(\frac{z}{2}\right)^n \int_1^\infty e^{iz\xi} (\xi^2-1)^{n-\frac{1}{2}} d\xi \\
 = & e^{3n\pi i} \frac{\sqrt{\pi}}{\Gamma(\frac{1}{2}+n)} \left(\frac{z}{2}\right)^n \int_1^\infty e^{iz\xi} (\xi^2-1)^{n-\frac{1}{2}} d\xi.
 \end{aligned}$$

Now let $\xi - 1 = e^{-\left(\frac{3}{2}\pi + \phi\right)i} \lambda$, so that λ is real and positive; then since, when $\xi = 1$, $\text{amp}(\xi + 1) = -2\pi$,

$$\xi + 1 = e^{-2\pi i} (2 + ie^{-i\phi} \lambda).$$

Thus

$$G_n(z) = \sqrt{\frac{\pi}{2}} \frac{1}{\Gamma(n + \frac{1}{2})} e^{(n+\frac{1}{2})\frac{\pi}{2}i - n\pi i + zi} \\ \times z^n \int_0^\infty e^{-z\lambda e^{-i\phi}} (\lambda e^{-i\phi})^{n-\frac{1}{2}} \left(1 + \frac{i}{2}\lambda e^{-i\phi}\right)^{n-\frac{1}{2}} d(\lambda e^{-i\phi}).$$

CASE II. Let $\pi/2 \leq \phi \leq 3\pi/2$.

Consider the integral

$$\int_C e^{iz\xi} (\xi^2 - 1)^{n-\frac{1}{2}} d\xi,$$

where C is the contour of Fig. 81, and the amplitudes of $\xi - 1$ and $\xi + 1$ are chosen to be zero at L. If $|\xi| > 1$,

$$\int_C e^{iz\xi} (\xi^2 - 1)^{n-\frac{1}{2}} d\xi \\ = \sum_{\nu=0}^{\infty} (-1)^\nu \frac{\Gamma(n + \frac{1}{2})}{\Gamma(\nu + 1)\Gamma(n + \frac{1}{2} - \nu)} \int_C e^{iz\xi} \xi^{2n-2\nu-1} d\xi;$$

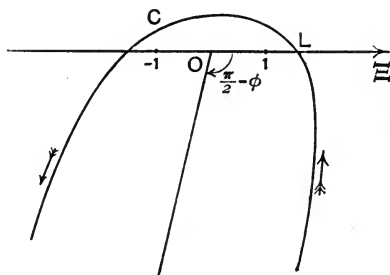

FIG. 81.

so that, applying the transformation $\lambda = e^{-\frac{1}{2}\pi i} z\xi$ to this integral, we obtain in the same way as before,

$$J_{-n}(z) = \frac{e^{-3n\pi i}}{2\pi i} \frac{\Gamma(\frac{1}{2} - n)}{\Gamma(\frac{1}{2})} \left(\frac{z}{2}\right)^n \int_C e^{iz\xi} (\xi^2 - 1)^{n-\frac{1}{2}} d\xi.$$

Next, let $R(n + \frac{1}{2}) > 0$, and $\pi/2 \leq \phi < 3\pi/2$; then, deforming C into a contour (Fig. 82) consisting of a line through $\xi = 1$, which makes an angle $\pi/2 - \phi$ with the positive ξ -axis, described from ∞ to 1, the ξ -axis from 1 to -1 , and this path reversed, we have

$$J_{-n}(z) = \{-e^{i\pi(n-\frac{1}{2})} + e^{3i\pi(n-\frac{1}{2})}\} \frac{e^{-3n\pi i}}{2\pi i} \frac{\Gamma(\frac{1}{2} - n)}{\Gamma(\frac{1}{2})} \\ \times \left(\frac{z}{2}\right)^n \int_{-1}^1 e^{iz\xi} (1 - \xi^2)^{n-\frac{1}{2}} d\xi$$

$$+ \{ -1 + e^{4(n-\frac{1}{2})\pi i} \} \frac{e^{-3n\pi i}}{2\pi i} \frac{\Gamma(\frac{1}{2}-n)}{\Gamma(\frac{1}{2})} \times \left(\frac{z}{2}\right)^n \int_1^\infty e^{iz\xi} (\xi^2-1)^{n-\frac{1}{2}} d\xi,$$

where in the latter integral $\xi-1$ and $\xi+1$ have the amplitudes corresponding to the first description of the line. Hence

$$J_{-n}(z) = e^{-n\pi i} J_n(z) + \frac{1}{\pi} e^{-n\pi i} \sin 2n\pi \frac{\Gamma(\frac{1}{2}-n)}{\Gamma(\frac{1}{2})} \times \left(\frac{z}{2}\right)^n \int_1^\infty e^{iz\xi} (\xi^2-1)^{n-\frac{1}{2}} d\xi;$$

so that
$$G_n(z) = e^{-n\pi i} \frac{\sqrt{\pi}}{\Gamma(\frac{1}{2}+n)} \left(\frac{z}{2}\right)^n \int_1^\infty e^{iz\xi} (\xi^2-1)^{n-\frac{1}{2}} d\xi.$$

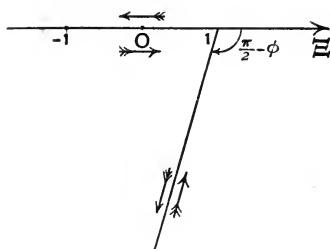

FIG. 82.

Now let $\xi-1 = e^{(\frac{\pi}{2}-\phi)i} \lambda$, so that λ is real and positive; then $\xi+1 = 2 + ie^{-i\phi} \lambda$.

Thus

$$G_n(z) = \sqrt{\frac{\pi}{2}} \frac{1}{\Gamma(n+\frac{1}{2})} e^{(n+\frac{1}{2})\frac{\pi}{2}i - n\pi i + zi} \times z^n \int_0^\infty e^{-z\lambda e^{-i\phi}} (\lambda e^{-i\phi})^{n-\frac{1}{2}} \left(1 + \frac{i}{2} \lambda e^{-i\phi}\right)^{n-\frac{1}{2}} d(\lambda e^{-i\phi}).$$

Accordingly, if $R(n+\frac{1}{2}) > 0$, this formula holds for all values of z such that $-\pi/2 < \phi < 3\pi/2$.

100. Asymptotic Expansions of the Bessel Functions. In

the formula obtained at the end of the previous section, let $z\lambda e^{-i\phi} = \xi$, so that ξ is real and positive; then

$$G_n(z) = \sqrt{\frac{\pi}{(2z)}} \frac{1}{\Gamma(n+\frac{1}{2})} e^{-\frac{n\pi i}{2} + i(z+\frac{\pi}{4})} \int_0^\infty e^{-\xi} \xi^{n-\frac{1}{2}} \left(1 + \frac{i\xi}{2z}\right)^{n-\frac{1}{2}} d\xi,$$

provided $R(n+\frac{1}{2}) > 0$, $-\pi/2 < \phi < 3\pi/2$. Hence

$$G_n(z) = \sqrt{\frac{\pi}{(2z)}} \frac{1}{\Gamma(n+\frac{1}{2})} e^{-\frac{n\pi i}{2} + i(z+\frac{\pi}{4})} \int_0^\infty e^{-\xi} \xi^{n-\frac{1}{2}} \left(1 + \frac{i\xi}{2z}\right)^{n-\frac{1}{2}} d\xi,$$

where the integral is taken along a line making an angle η with the positive real axis such that $-\pi/2 < \eta < \pi/2$. Thus

$$\begin{aligned} G_n(z) &= \sqrt{\frac{\pi}{(2z)}} e^{-\frac{n\pi i}{2} + i(z + \frac{\pi}{4})} \\ &\quad \times \left\{ \sum_{\nu=0}^{s-1} \frac{1}{\Gamma(\nu+1)\Gamma(n+\frac{1}{2}-\nu)} \left(\frac{i}{2z}\right)^\nu \int_0^\infty e^{-\xi} \xi^{n+\nu-\frac{1}{2}} d\xi + R_s \right\} \\ &= \sqrt{\frac{\pi}{(2z)}} e^{-\frac{n\pi i}{2} + i(z + \frac{\pi}{4})} \left\{ \sum_{\nu=0}^{s-1} \frac{\Gamma(n+\frac{1}{2}+\nu)}{\Gamma(\nu+1)\Gamma(n+\frac{1}{2}-\nu)} \left(\frac{i}{2z}\right)^\nu + R_s \right\}. \end{aligned}$$

Now let $\xi = ue^{i\eta}$, so that u is real and positive; also let $F(u) = \psi(u) + i\chi(u)$, where $\psi(u)$ and $\chi(u)$ are real functions and

$$F(u) = \left(1 + \frac{ie^{i\eta}u}{2z}\right)^{n-\frac{1}{2}}.$$

Then

$$\psi(u) = \psi(0) + u\psi'(0) + \dots + \frac{u^{s-1}}{(s-1)!} \psi^{(s-1)}(0) + \frac{u^s}{s!} \psi^{(s)}(\theta u),$$

$$\chi(u) = \chi(0) + u\chi'(0) + \dots + \frac{u^{s-1}}{(s-1)!} \chi^{(s-1)}(0) + \frac{u^s}{s!} \chi^{(s)}(\theta' u),$$

where $0 < \theta < 1$, $0 < \theta' < 1$. Therefore

$$F(u) = F(0) + uF'(0) + \dots + \frac{u^{s-1}}{(s-1)!} F^{(s-1)}(0) + \frac{u^s}{s!} \{\psi^{(s)}(\theta u) + \chi^{(s)}(\theta' u)\}.$$

Hence

$$R_s = \frac{1}{\Gamma(n+\frac{1}{2})\Gamma(s+1)} \int_0^\infty e^{-\xi} \xi^{n-\frac{1}{2}+s} e^{-is\eta} \{\psi^{(s)}(\theta u) + \chi^{(s)}(\theta' u)\} d\xi.$$

$$\text{Again, } F^{(s)}(u) = \frac{\Gamma(n+\frac{1}{2})}{\Gamma(n+\frac{1}{2}-s)} \left(\frac{ie^{i\eta}}{2z}\right)^s \left(1 + \frac{ie^{i\eta}u}{2z}\right)^{n-\frac{1}{2}-s}.$$

$$\begin{aligned} \text{But } \left|1 + \frac{ie^{i\eta}u}{2z}\right| &= \sqrt{\left\{1 - \frac{u}{\rho} \sin(\eta - \phi) + \frac{u^2}{4\rho^2}\right\}}, \text{ where } z = \rho e^{i\phi} \\ &= \sqrt{\left[\cos^2(\eta - \phi) + \left\{\sin(\eta - \phi) - \frac{u}{2\rho}\right\}^2\right]} \\ &\geq |\cos(\eta - \phi)|. \end{aligned}$$

$$\text{Now let } \text{amp}\left(1 + \frac{ie^{i\eta}u}{2z}\right) = \tau;$$

then, if $\cos(\eta - \phi) \neq 0$, as u increases from 0 to ∞ , $-\pi < \tau < \pi$.

Hence, if $n = \alpha + i\beta$, and if $s > \alpha - \frac{1}{2}$,

$$\left|\left(1 + \frac{ie^{i\eta}u}{2z}\right)^{n-\frac{1}{2}-s}\right| \leq \frac{e^{\pi|\beta|}}{|\cos(\eta - \phi)|^{s-\alpha+\frac{1}{2}}}.$$

Thus
$$|F^{(s)}(u)| \leq \frac{M}{|2z|^s},$$

where
$$M = \left| \frac{\Gamma(n + \frac{1}{2})}{\Gamma(n + \frac{1}{2} - s)} \right| \frac{e^{\pi|\beta|}}{|\cos(\eta - \phi)|^{s - a + \frac{1}{2}}}.$$

Therefore

$$\begin{aligned} |\psi^{(s)}(\theta u) + \chi^{(s)}(\theta' u)| &= \sqrt{[\{\psi^{(s)}(\theta u)\}^2 + \{\chi^{(s)}(\theta' u)\}^2]} \\ &\leq \frac{\sqrt{2M}}{|2z|^s}. \end{aligned}$$

It follows that

$$\begin{aligned} |R_s| &\leq \frac{1}{|\Gamma(n + \frac{1}{2})\Gamma(s + 1)|} \frac{\sqrt{2M}e^{-\beta\eta}}{|2z|^s} \int_0^\infty e^{-|\zeta|\cos\eta} |\xi|^{a - \frac{1}{2} + s} d|\xi| \\ &\leq \frac{1}{|\Gamma(n + \frac{1}{2})\Gamma(s + 1)|} \frac{\sqrt{2M}e^{-\beta\eta}\Gamma(\alpha + \frac{1}{2} + s)}{|2z|^s(\cos\eta)^{\alpha + \frac{1}{2} + s}}. \end{aligned}$$

But η can always be chosen so that M is finite; therefore, by sufficiently increasing $|z|$, $|R_s|$ can be made arbitrarily small. Hence the series is asymptotic.

Note 1. The expansion can be written

$$\begin{aligned} G_n(z) &= \sqrt{\frac{\pi}{(2z)}} e^{-\frac{n\pi i}{2} + i(z + \frac{\pi}{4})} \\ &\times \left[\left\{ 1 - \frac{(4n^2 - 1^2)(4n^2 - 3^2)}{2!(8z)^2} + \frac{(4n^2 - 1^2)(4n^2 - 3^2)(4n^2 - 5^2)(4n^2 - 7^2)}{4!(8z)^4} - \dots \right\} \right. \\ &\quad \left. + i \left\{ \frac{(4n^2 - 1^2)}{1!8z} - \frac{(4n^2 - 1^2)(4n^2 - 3^2)(4n^2 - 5^2)}{3!(8z)^3} + \dots \right\} \right]. \end{aligned}$$

Note 2. Since $G_{-n}(z) = e^{in\pi}G_n(z)$, the expansion also holds when $R(n + \frac{1}{2}) \gtrless 0$.

Asymptotic expansion of $J_n(z)$. Again, since $J_n(ze^{i\pi}) = e^{in\pi}J_n(z)$, we can write $\pi iJ_n(z) = G_n(z) - e^{in\pi}G_n(ze^{i\pi})$.

Thus, if $-\pi/2 < \phi < \pi/2$, the asymptotic expansion for $J_n(z)$ is given by

$$\begin{aligned} J_n(z) &= \sqrt{\frac{2}{(\pi z)}} \left\{ 1 - \frac{(4n^2 - 1^2)(4n^2 - 3^2)}{2!(8z)^2} \right. \\ &\quad \left. + \frac{(4n^2 - 1^2)(4n^2 - 3^2)(4n^2 - 5^2)(4n^2 - 7^2)}{4!(8z)^4} - \dots \right\} \cos\left(z - \frac{\pi}{4} - \frac{n\pi}{2}\right) \\ &\quad - \sqrt{\frac{2}{(\pi z)}} \left\{ \frac{(4n^2 - 1^2)}{1!8z} - \frac{(4n^2 - 1^2)(4n^2 - 3^2)(4n^2 - 5^2)}{3!(8z)^3} + \dots \right\} \\ &\quad \times \sin\left(z - \frac{\pi}{4} - \frac{n\pi}{2}\right). \end{aligned}$$

Also, since $J_n(z) = e^{in\pi} J_n(ze^{-i\pi})$, it follows that, when

$$\pi/2 < \phi < 3\pi/2,$$

the expansion is

$$\begin{aligned} J_n(z) = & i e^{in\pi} \sqrt{\frac{2}{(\pi z)}} \left\{ 1 - \frac{(4n^2 - 1^2)(4n^2 - 3^2)}{2!(8z)^2} + \dots \right\} \cos\left(z + \frac{\pi}{4} + \frac{n\pi}{2}\right) \\ & - i e^{in\pi} \sqrt{\frac{2}{(\pi z)}} \left\{ \frac{4n^2 - 1^2}{1!8z} - \frac{(4n^2 - 1^2)(4n^2 - 3^2)(4n^2 - 5^2)}{3!(8z)^3} + \dots \right\} \\ & \times \sin\left(z + \frac{\pi}{4} + \frac{n\pi}{2}\right). \end{aligned}$$

COROLLARY. The difference between two consecutive zeros of $J_n(z)$ tends to the limit π as z tends to infinity.

Example. Prove

$$\lim_{a \rightarrow \infty} \frac{1}{a^2} \sum_s \frac{J_0(m_s a)}{\{J_1(m_s a)\}^2} e^{-km_s^2} = \int_0^\infty J_0(x) x e^{-kx^2} dx,$$

where k is positive, and the quantities m_s are the zeros of the function $J_0(ma)$ regarded as a function of m .

Since $G_0(ma)J_0'(ma) - J_0(ma)G_0'(ma) = \frac{1}{ma}$, (cf. p. 241)

$$G_0(m_s a) = \frac{1}{m_s a J_0'(m_s a)} = -\frac{1}{m_s a J_1(m_s a)}.$$

Now $\int_C \frac{G_0(za)J_0(zr)}{J_0(za)} ze^{-kz^2} dz = 2\pi i \sum \frac{G_0(m_s a)J_0(m_s r)}{\frac{\partial}{\partial m_s} J_0(m_s a)} m_s e^{-km_s^2}$,

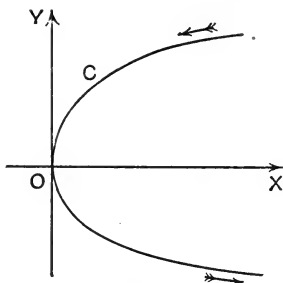

FIG. 83.

where C (Fig. 83) denotes a closed curve which crosses the x -axis at the origin and at an infinitely distant point between two zeros of $J_0(za)$, and the summation extends to all positive values of m_s . Therefore, since $J_0(za)$ is an even function of z ,

$$\int_C \frac{G_0(za)J_0(zr)}{J_0(za)} ze^{-kz^2} dz = \pi i \sum_s \frac{1}{a^2} \frac{J_0(m_s r)}{\{J_1(m_s a)\}^2} e^{-km_s^2}.$$

But $\lim_{a \rightarrow \infty} \left\{ \frac{G_0(za)}{J_0(za)} \right\} = \begin{cases} 0, & \text{if } I(z) > 0, \\ \pi i, & \text{if } I(z) < 0. \end{cases}$

Hence $\lim_{a \rightarrow \infty} \frac{1}{a^2} \sum_s \frac{J_0(m_s r)}{\{J_1(m_s a)\}^2} e^{-km_s^2} = \int_0^\infty J_0(xr) x e^{-kx^2} dx.$

EXAMPLES XV.

1. If $R(\beta) > 0$, $R(\gamma - \beta) > 0$, shew that

$$\int_0^1 \xi^{\beta-1} (1-\xi)^{\gamma-\beta-1} (1-z\xi)^{-\alpha} d\xi = B(\beta, \gamma - \beta) F(\alpha, \beta, \gamma, z).$$

Use this formula to prove Gauss's Theorem.

2. If m is a positive integer, shew that

$$P_n^m(z) = \frac{(z^2-1)^{\frac{1}{2}m}}{2^m \Pi(m)} \frac{\Pi(n+m)}{\Pi(n-m)} F\left(m-n, m+n+1, m+1, \frac{1-z}{2}\right);$$

deduce that
$$P_n^{-m}(z) = \frac{\Pi(n-m)}{\Pi(n+m)} P_n^m(z).$$

3. If m is a positive integer, shew that

$$P_n^m(z) = \frac{1}{2\pi i} \frac{\Gamma(n+m+1)}{\Gamma(n+1)} \frac{(z^2-1)^{\frac{1}{2}m}}{2^n} \int^{(z+, 1+)} (\xi^2-1)^n (\xi-z)^{-n-m-1} d\xi.$$

[Use Ex. 1, § 97.]

4. Use Ex. 1, § 97, to prove that, if m and n are integers such that

$$n \geq 0, \quad m \geq -n,$$

$$P_n^m(z) = \frac{1}{2\pi i} \frac{\Pi(n+m)}{\Pi(n)} \frac{(z^2-1)^{\frac{1}{2}m}}{2^n} \int_C (\xi^2-1)^n (\xi-z)^{-n-m-1} d\xi,$$

where C is a closed curve enclosing $\xi = z$.

5. Establish the formulae :

(i) $P_{n+1}^m(z) = z P_n^m(z) + (z^2-1)^{\frac{1}{2}}(n+m) P_n^{m-1}(z);$

(ii) $P_{n-1}^m(z) = z P_n^m(z) - (z^2-1)^{\frac{1}{2}}(n-m+1) P_n^{m-1}(z);$

(iii) $(n-m+1) P_{n+1}^m(z) - (2n+1) z P_n^m(z) + (n+m) P_{n-1}^m(z) = 0.$

[Apply the method of partial integration to the definite integral form for $P_n^m(z)$.]

6. Shew that the formulae of the previous example also hold for $Q_n^m(z)$.

7. If $|z| < 1$, shew that

$$\begin{aligned} Q_n^m(z) = & e^{\mp(m+n+1)\frac{\pi i}{2}} \frac{e^{m\pi i}}{2} 2^m \frac{\Gamma\left(\frac{n+m+1}{2}\right) \Gamma\left(\frac{1}{2}\right)}{\Gamma\left(\frac{n-m+2}{2}\right)} \\ & \times (z^2-1)^{\frac{1}{2}m} F\left(\frac{n+m+1}{2}, \frac{m-n}{2}, \frac{1}{2}, z^2\right) \\ & + e^{\mp(m+n)\frac{\pi i}{2}} \frac{e^{m\pi i}}{2} 2^m \frac{\Gamma\left(\frac{n+m+2}{2}\right) \Gamma\left(\frac{1}{2}\right)}{\Gamma\left(\frac{n-m+1}{2}\right)} \\ & \times (z^2-1)^{\frac{1}{2}m} z F\left(\frac{m-n+1}{2}, \frac{m+n+2}{2}, \frac{3}{2}, z^2\right), \end{aligned}$$

according as $I(z) \geq 0$.

[Use Exs. VIII. 20, and Ex. 2, § 62.]

8. Prove that $P_n(z) = \frac{1}{\pi} \tan n\pi \{Q_n(z) - Q_{-n-1}(z)\}.$

9. Prove that

$$P_n^{-m}(z) = \frac{e^{-m\pi i}}{\pi \cos n\pi} \frac{\Gamma(n-m+1)}{\Gamma(n+m+1)} \sin(n-m)\pi \{Q_n^m(z) - Q_{-n-1}^m(z)\}.$$

[Use the second expression given in § 97 for $Q_n^m(z)$.]

10. Prove that

$$P_n^{-m}(z) = \frac{\Gamma(n-m+1)}{\Gamma(n+m+1)} \left\{ P_n^m(z) - \frac{2}{\pi} e^{-m\pi i} \sin m\pi Q_n^m(z) \right\}.$$

[Use Exs. 9, 2, § 97.]

11. Shew that

$$(i) P_n^m(-z) = e^{\mp n\pi i} P_n^m(z) - \frac{2}{\pi} \sin(n+m)\pi e^{-m\pi i} Q_n^m(z),$$

$$(ii) Q_n^m(-z) = -e^{\pm n\pi i} Q_n^m(z),$$

according as $I(z) \geq 0$.

12. Shew that, if $|z| > 1$,

$$\begin{aligned} P_n^m(z) &= \frac{\sin(n+m)\pi}{2^{n+1} \cos n\pi} \frac{\Gamma(n+m+1)}{\Gamma(n+\frac{3}{2})\Gamma(\frac{1}{2})} \\ &\quad \times \frac{(z^2-1)^{1/2m}}{z^{n+m+1}} F\left(\frac{n+m+2}{2}, \frac{n+m+1}{2}, n+\frac{3}{2}, \frac{1}{z^2}\right) \\ &\quad + 2^n \frac{\Gamma(n+\frac{1}{2})}{\Gamma(n-m+1)\Gamma(\frac{1}{2})} \\ &\quad \times (z^2-1)^{1/2m} z^{n-m} F\left(\frac{m-n+1}{2}, \frac{m-n}{2}, \frac{1}{2}-n, \frac{1}{z^2}\right). \end{aligned}$$

[Use Ex. 2, § 97.]

13. Shew that, if $|z| < 1$,

$$\begin{aligned} P_n^m(z) &= e^{\mp m\pi i} 2^m \cos\left(\frac{n+m}{2}\pi\right) \frac{\Gamma\left(\frac{n+m+1}{2}\right)}{\Gamma\left(\frac{n-m+2}{2}\right)\Gamma\left(\frac{1}{2}\right)} \\ &\quad \times (z^2-1)^{1/2m} F\left(\frac{m+n+1}{2}, \frac{m-n}{2}, \frac{1}{2}, z^2\right) \\ &\quad + e^{\mp m\pi i} 2^m \sin\left(\frac{n+m}{2}\pi\right) \frac{\Gamma\left(\frac{n+m+2}{2}\right)}{\Gamma\left(\frac{n-m+1}{2}\right)\Gamma\left(\frac{3}{2}\right)} \\ &\quad \times (z^2-1)^{1/2m} z F\left(\frac{m+n+2}{2}, \frac{m-n+1}{2}, \frac{3}{2}, z^2\right), \end{aligned}$$

according as $I(z) \geq 0$.

14. Shew that

$$J_n(z) = \frac{i}{2\sqrt{\pi}} \frac{1}{\cos n\pi \Gamma(n+\frac{1}{2})} \left(\frac{z}{2}\right)^n \int^{(-1+, +1-)} (\xi^2-1)^{n-\frac{1}{2}} \cos(z\xi) d\xi.$$

15. If $R(n+\frac{1}{2}) > 0$, shew that

$$(i) J_n(z) = \frac{1}{\Gamma(\frac{1}{2})\Gamma(n+\frac{1}{2})} \left(\frac{z}{2}\right)^n \int_{-1}^1 e^{-iz\xi} (1-\xi^2)^{n-\frac{1}{2}} d\xi;$$

$$(ii) J_n(z) = \frac{1}{\Gamma(\frac{1}{2})\Gamma(n+\frac{1}{2})} \left(\frac{z}{2}\right)^n \int_0^\pi \cos(z \cos \phi) \sin^{2n} \phi d\phi.$$

MISCELLANEOUS EXAMPLES.

1. Shew that

$$|z_1 + z_2|^2 + |z_1 - z_2|^2 = 2\{|z_1|^2 + |z_2|^2\},$$

and give a geometrical interpretation of this equation.

2. If n is a positive integer, prove that

$$(i) \quad z^{2n} - a^{2n} = (z^2 - a^2) \left(z^2 - 2az \cos \frac{\pi}{n} + a^2 \right) \dots \left\{ z^2 - 2az \cos \frac{(n-1)\pi}{n} + a^2 \right\},$$

$$(ii) \quad z^{2n} - 2a^n z^n \cos \theta + a^{2n} = \left(z^2 - 2az \cos \frac{\theta}{n} + a^2 \right) \\ \times \left(z^2 - 2az \cos \frac{\theta + 2\pi}{n} + a^2 \right) \dots \left\{ z^2 - 2az \cos \frac{\theta + 2(n-1)\pi}{n} + a^2 \right\}.$$

3. Prove that, if the points z_1, z_2, z_3 , are the vertices of an equilateral triangle,

$$z_1^2 + z_2^2 + z_3^2 = z_1 z_2 + z_2 z_3 + z_3 z_1.$$

4. If z_1, z_2, z_3 , are the vertices of an isosceles triangle, right-angled at the vertex z_2 , prove that

$$z_1^2 + 2z_2^2 + z_3^2 = 2z_2(z_1 + z_3).$$

5. If $(z_1 - z_2)(z_1' - z_2') = (z_2 - z_3)(z_2' - z_3') = (z_3 - z_1)(z_3' - z_1')$,

shew that the triangles whose vertices are z_1, z_2, z_3 , and z_1', z_2', z_3' , are equilateral.

6. Similar triangles QRL, RPM, PQN, are described on the sides of the triangle PQR. Shew that the centroids of triangles PQR and LMN are coincident.

7. If a_1, a_2, a_3 , and b_1, b_2, b_3 , are the vertices of two triangles which are directly similar, shew that any three points which divide the line joining the pairs of points $a_1, b_1; a_2, b_2; a_3, b_3$; in the same ratio, form a third similar triangle.

8. If the lines joining z_2 and z_3, z_3 and z_1, z_1 and z_2 , are divided in the same ratio r at z_1', z_2', z_3' , respectively, and if the triangles whose vertices are z_1, z_2, z_3 , and z_1', z_2', z_3' , are similar, shew that either $r=1$ or else both triangles are equilateral.

9. Let ABCD be a parallelogram of which AC is a diagonal, and let ABX, DCY, ACZ, be similar triangles. Prove that triangle XYZ is similar to each of them.

10. OCAD, OEBF, are circles, where O, A, B, C, D, E, F, are the points $(0, 0), (2, 0), (6, 0), (1, 1), (1, -1), (3, 3), (3, -3)$, respectively. If $w = \sqrt{\{(1-z)(4-z)\}}$, and if $w=2$ when $z=0$, find the values of w at A when z moves from O to A (i) along OCA, (ii) along ODA; find also the values of w at B when z moves from O to B (i) along OEB, (ii) along OFB.

Ans. $-i\sqrt{2}, i\sqrt{2}, -\sqrt{(10)}, -\sqrt{(10)}$.

11. Shew that the equation $w = \frac{1}{2}(z + z^{-1})$, where $z = re^{i\theta}$, determines a transformation which carries over circles, $r = \text{constant}$, and straight lines, $\theta = \text{constant}$, into confocal ellipses and hyperbolas respectively. Sketch the system of confocals. If P is any point within the circle $|z| = 1$, shew that there is a point Q outside that circle which is carried over into the same point of the w -plane as P is transformed into.

12. If $w = a(z - c)/(z + c)$, where a and c are real and positive, shew that the interior of the circle $|z| = c$ in the z -plane corresponds to that half of the w -plane which lies to the left of the imaginary axis.

13. If $w = 1/z$, and if the point z describes that part of the line $4y = 3(x - 2)$ which lies in the first quadrant, find the path described by the point w . Shew on the same diagram the path described by w when z describes that part of the line $4y + 3(x - 2) = 0$ which lies in the fourth quadrant. Indicate in each case the direction of motion.

Ans. Those parts of the circles $6u^2 + 6v^2 = 3u \pm 4v$ which lie in the fourth and first quadrants respectively.

14. Shew that the transformation $w = 4/(z + 1)^2$ transforms the circle $|z| = 1$ into the parabola $v^2 = 4(1 - u)$, and that the interior of the circle corresponds to the exterior of the parabola.

15. Shew that all the roots of $z^5 + 2z^2 + z + 3 = 0$ are in absolute value less than 1.6.

[Cf. the proof of the Theorem of § 10.]

16. If a and b are real and positive, shew that the equation $z^{2p} + az + b = 0$ has $2p$ roots to the right, and $2p$ to the left, of the imaginary axis. If b is negative, shew that $2p + 1$ roots lie to the right, and $2p - 1$ to the left, of the imaginary axis.

17. If a and b are real, shew that the equation $z^{2p-1} + az + b = 0$ has $2p$ or $2p - 1$ roots to the right of the y -axis, according as b is positive or negative.

18. Prove that: (i) $\lim_{z \rightarrow \pi/2} (\sec z - \tan z) = 0$;

$$(ii) \lim_{z \rightarrow 1} \frac{\cos\left(\frac{2\pi z + \pi}{6}\right)}{\sin \pi z} = \frac{1}{3}; \quad (iii) \lim_{z \rightarrow 1} \frac{\sin\left(\frac{2\pi z + \pi}{3}\right)}{\sin \pi z} = \frac{2}{3}.$$

19. Shew that

$$(i) \tan(x + iy) = \frac{\sin 2x + i \sinh 2y}{\cosh 2y + \cos 2x}; \quad (ii) \cot(x + iy) = \frac{\sin 2x - i \sinh 2y}{\cosh 2y - \cos 2x}.$$

20. If z tends to infinity along a straight line through the origin, shew that $\lim_{z \rightarrow \infty} \tan z = \pm i$, according as the line lies above or below the real axis.

21. If $w = \cosh z$, shew that the whole w -plane corresponds to any strip of the z -plane of breadth π bounded by lines parallel to the x -axis. Also shew that, to the lines $x = \text{constant}$, $y = \text{constant}$, correspond the confocal ellipses and hyperbolas,

$$\frac{u^2}{\cosh^2 x} + \frac{v^2}{\sinh^2 x} = 1, \quad \frac{u^2}{\cos^2 y} - \frac{v^2}{\sin^2 y} = 1.$$

22. If $w = \log\{(z-a)/(z-b)\}$, shew that the lines $u = \text{constant}$ correspond to a coaxial system of circles whose limiting points are a and b , while the lines $v = \text{constant}$ correspond to the orthogonal system.

23. If $z = c \tanh(\pi w)$, shew that the lines $u = u_0$ correspond to the coaxial circles

$$\{x - c \coth(2\pi u_0)\}^2 + y^2 = c^2 \operatorname{cosech}^2(2\pi u_0),$$

and the lines $v = v_0$ to the orthogonal system of coaxial circles.

24. If the sequence z_1, z_2, z_3, \dots , is convergent, shew that the sequence

$$z_1, \frac{z_1 + z_2}{2}, \frac{z_1 + z_2 + z_3}{3}, \dots,$$

converges to the same limit.

25. If the sequences z_1, z_2, z_3, \dots , and z'_1, z'_2, z'_3, \dots , converge to the limits z and z' respectively, shew that the sequence w_1, w_2, w_3, \dots , where

$$w_n = (z_1 z'_n + z_2 z'_{n-1} + \dots + z_n z'_1) / n,$$

converges to the limit zz' .

26. Integrate $e^{az}/(1+e^z)$, where $0 < a < 1$, round the rectangle whose sides are $x = \pm R, y = 0, y = 2\pi$, and shew that

$$\int_{-\infty}^{\infty} \frac{e^{ax} dx}{1+e^x} = \frac{\pi}{\sin a\pi}.$$

27. Prove that

$$\begin{aligned} \int_0^{\frac{\pi}{2}} \frac{1-r \cos 2\theta}{1-2r \cos 2\theta+r^2} \log \cos \theta d\theta &= \int_0^{\frac{\pi}{2}} \frac{1+r \cos 2\theta}{1+2r \cos 2\theta+r^2} \log \sin \theta d\theta \\ &= \begin{cases} \frac{\pi}{4} \log \frac{1+r}{4}, & \text{if } -1 < r < 1, \\ \frac{\pi}{4} \log \frac{r}{1+r}, & \text{if } r < -1 \text{ or } r > 1. \end{cases} \end{aligned}$$

Deduce that $\int_0^{\frac{\pi}{2}} \log(\cos \theta) d\theta = \int_0^{\frac{\pi}{2}} \log(\sin \theta) d\theta = \frac{\pi}{2} \log \frac{1}{2}$.

[Integrate $\frac{z^2(1+r)+(1-r)}{z^2(1+r)^2+(1-r)^2} \frac{\log(1-iz)}{1+z^2}$ round the contour of Fig. 33, and put $x = \tan \theta$.]

28. If $-2 < a < 2$, prove that

$$\begin{aligned} \int_0^{\frac{\pi}{2}} \frac{r \sin 2\theta}{1-2r \cos 2\theta+r^2} (\tan \theta)^a d\theta &= \int_0^{\frac{\pi}{2}} \frac{r \sin 2\theta}{1+2r \cos 2\theta+r^2} (\cot \theta)^a d\theta \\ &= \begin{cases} \frac{\pi}{4 \sin \frac{1}{2} a\pi} \left\{ 1 - \left(\frac{1-r}{1+r} \right)^a \right\}, & \text{if } -1 < r < 1, \\ \frac{\pi}{4 \sin \frac{1}{2} a\pi} \left\{ 1 - \left(\frac{r-1}{r+1} \right)^a \right\}, & \text{if } r < -1 \text{ or } r > 1. \end{cases} \end{aligned}$$

Deduce that, if $-2 < a < 2$,

$$\int_0^{\frac{\pi}{2}} \sin 2\theta (\tan \theta)^a d\theta = \int_0^{\frac{\pi}{2}} \sin 2\theta (\cot \theta)^a d\theta = \frac{\pi a}{2 \sin \frac{1}{2} a\pi}.$$

[Integrate $\frac{2rz}{z^2(1+r)^2+(1-r)^2} \frac{z^a}{1+z^2}$ round the contour of Fig. 37.]

29. By integrating $\frac{\log(1+is/z)}{r-iz}$ and $\frac{\log(1+is/z)}{r+iz}$, where r and s are real and positive, prove that

$$\int_0^\infty \log\left(1+\frac{s^2}{x^2}\right) \frac{r dx}{x^2+r^2} = \pi \log\left(1+\frac{s}{r}\right) = 2 \int_0^\infty \tan^{-1}\left(\frac{s}{x}\right) \frac{x dx}{x^2+r^2}.$$

30. By integrating $\log\left(1+i\frac{s}{z}\right) \frac{r}{z^2-r^2}$ and $\log\left(1+i\frac{s}{z}\right) \frac{z}{z^2-r^2}$, where r and s are real and positive, prove that

$$(i) \text{ P } \int_0^\infty \log\left(1+\frac{s^2}{x^2}\right) \frac{r dx}{x^2-r^2} = -\pi \tan^{-1}\left(\frac{s}{r}\right),$$

$$(ii) \text{ P } \int_0^\infty \tan^{-1}\left(\frac{s}{x}\right) \frac{x dx}{x^2-r^2} = \frac{\pi}{4} \log\left(1+\frac{s^2}{r^2}\right).$$

31. If a , c , and m are real quantities such that $m \geq 0$, $c > 0$, shew that

$$(i) \int_{-\infty}^\infty \frac{\sin m(x-a)}{x-a} \frac{dx}{x^2+c^2} = \frac{\pi}{\alpha^2+c^2} \left\{ 1 - \frac{e^{-mc}}{c} (c \cos ma - a \sin ma) \right\},$$

$$(ii) \text{ P } \int_{-\infty}^\infty \frac{\cos m(x-a)}{x-a} \frac{dx}{x^2+c^2} = -\frac{\pi e^{-mc}}{c(\alpha^2+c^2)} (a \cos ma + c \sin ma).$$

32. Shew that, if a and b are real, and $m \geq n \geq 0$,

$$\int_{-\infty}^\infty \frac{\sin m(x-a)}{x-a} \frac{\sin n(x-b)}{x-b} dx = \pi \frac{\sin n(a-b)}{a-b}.$$

33. Prove that $\int_0^\infty \frac{\sin ax}{e^{2\pi x}+1} dx = \frac{1}{2a} - \frac{1}{4 \sinh \frac{1}{2}a}$.

34. If $0 \leq r < 1$, shew that

$$\int_0^{2\pi} \frac{d\theta}{1-2r \cos \theta + r^2} = \frac{2\pi}{1-r^2}.$$

35. Shew that $\int_0^{2\pi} \frac{d\theta}{1-ae^{i\theta}} = 2\pi$ or 0 , according as $|a| < 1$ or $|a| > 1$.

36. Shew that, if $|a_n| \leq 1$ for all values of n , the equation

$$0 = 1 + a_1 z + a_2 z^2 + \dots$$

cannot have a root whose modulus is less than $\frac{1}{2}$. Also shew that the only case in which it can have a root $z = \frac{1}{2}e^{i\theta}$ is when $a_n = -e^{-in\theta}$, ($n = 1, 2, 3, \dots$).

37. Shew that, if $R(z) < \frac{1}{2}$,

$$1 + \frac{z}{1-z} + \left(\frac{z}{1-z}\right)^2 + \dots = \frac{1-z}{1-2z}.$$

38. If $|z| < 1$, shew that

$$\frac{1}{(1+z+z^2)^2} = \frac{4}{3} \sum_{n=0}^\infty z^n \left\{ \frac{1}{\sqrt{3}} \sin \frac{2(n+1)\pi}{3} - \frac{n+1}{2} \cos \frac{2(n+2)\pi}{3} \right\}.$$

39. Shew that

$$(i) \lim_{z \rightarrow 1} (1 + \cos \pi z) / \tan^2 \pi z = \frac{1}{2}; \quad (ii) \lim_{z \rightarrow 0} \frac{1 - \cos(1 - \cos z)}{z^4} = \frac{1}{8}.$$

40. Shew that, if $|z| < 1$ or $|z| > 1$, the series

$$\sum_1^{\infty} \frac{z^n - z^{-n-1}}{(z^n + z^{-n})(z^{n+1} + z^{-n-1})}$$

has the sum $z/\{(z-1)(z^2+1)\}$.

41. Prove that (i) $|\cos z| \leq \cosh |z|$, (ii) $|\sin z| \leq \sinh |z|$.
[Use the Taylor's Series for $\cos z$ and $\sin z$.]

42. If $|z| > 1$, shew that

$$\frac{1}{z+1} + \frac{2}{z^2+1} + \frac{4}{z^4+1} + \dots = \frac{1}{z-1}.$$

43. Shew that the series

$$1 - z + \frac{z(z-1)}{2!} - \frac{z(z-1)(z-2)}{3!} + \dots$$

is convergent if $R(z) > 0$, divergent if $R(z) < 0$.

44. Shew that the series

$$\sum_0^{\infty} \left\{ \frac{1}{z+n} - \log \left(1 + \frac{1}{z+n} \right) \right\}$$

is convergent for all values of z except 0, -1, -2, -3, ...

45. Shew that, for points interior to the circle $3x^2 + 3y^2 + 2x - 1 = 0$,

$$\frac{1}{1-z} + \frac{2z}{(1-z)^2} + \frac{4z^2}{(1-z)^3} + \dots = \frac{1}{1-3z}.$$

46. Prove that, if $|z| < 1$, and the principal value of $\tan^{-1}z$ is taken,

$$\log(1+z^2) \cdot \tan^{-1}z = 2 \left\{ \frac{1}{3} \left(1 + \frac{1}{2} \right) z^3 - \frac{1}{5} \left(1 + \frac{1}{2} + \frac{1}{3} + \frac{1}{4} \right) z^5 + \dots \right\}.$$

47. If $|z| < 1$, shew that

$$\frac{z}{1-z} + \frac{2z^2}{1-z^2} + \frac{3z^3}{1-z^3} + \dots = \frac{z}{(1-z)^2} + \frac{z^2}{(1-z^2)^2} + \frac{z^3}{(1-z^3)^2} + \dots$$

48. If α is neither zero nor a multiple of 2π , shew that

$$\frac{\cosh z - \cos \alpha}{1 - \cos \alpha} = \prod_{-\infty}^{\infty} \left\{ 1 + \frac{z^2}{(2n\pi + \alpha)^2} \right\}.$$

49. Shew that

$$\frac{\sin z}{z} = \left(1 - \frac{4}{3} \sin^2 \frac{z}{3} \right) \left(1 - \frac{4}{3} \sin^2 \frac{z}{3^2} \right) \left(1 - \frac{4}{3} \sin^2 \frac{z}{3^3} \right) \dots$$

50. Shew that

$$(i) \frac{\cos z}{1 + \sin z} = \frac{4}{\pi + 2z} - 8 \sum_1^{\infty} \frac{\pi + 2z}{4^2 n^2 \pi^2 - (\pi + 2z)^2};$$

$$(ii) 1 + \sin z = \frac{1}{8} (\pi + 2z)^2 \prod_1^{\infty} \left\{ 1 - \frac{(\pi + 2z)^2}{4^2 n^2 \pi^2} \right\}^2.$$

51. Shew that the series

$$1 - \frac{1}{1+z} + \frac{1}{2} - \frac{1}{2+z} + \frac{1}{3} - \frac{1}{3+z} + \dots$$

represents a meromorphic function with simple poles at the points -1, -2, -3, ...

52. If a is positive, shew that

$$\int_0^{\infty} \frac{\cos ax}{(1+x^2)^3} dx = \frac{\pi e^{-a}}{16} (a^2 + 3a + 3).$$

53. Shew that

$$(1-z)(1+\frac{1}{3}z)(1-\frac{1}{3}z)(1+\frac{1}{9}z) - \dots = \cos(\frac{1}{4}\pi z) - \sin(\frac{1}{4}\pi z).$$

54. Prove that (i) $\frac{\sin \pi(z+c)}{\sin \pi c} = \frac{z+c}{c} \prod_{-\infty}^{\infty} \left(1 - \frac{z}{n-c}\right) e^{\frac{z}{n}}$,

$$(ii) 1 - \frac{\sin^2 \pi z}{\sin^2 \pi c} = \prod_{-\infty}^{\infty} \left\{1 - \frac{z^2}{(n-c)^2}\right\}.$$

55. Shew that $\prod_{-\infty}^{\infty} \left\{1 - \frac{4z^2}{(n\pi+z)^2}\right\} = -\frac{\sin 3z}{\sin z}$.

56. Shew that $\int_0^{\frac{\pi}{2}} e^{-z \cos \theta} \cos(z \sin \theta) d\theta = \frac{\pi}{2} - \int_0^z \frac{\sin x}{x} dx$.

57. Shew that $\sum_{-\infty}^{\infty} \frac{1}{n^4 + x^4} = \frac{\pi}{x^3 \sqrt{2}} \frac{\sinh(\pi x \sqrt{2}) + \sin(\pi x \sqrt{2})}{\cosh(\pi x \sqrt{2}) - \cos(\pi x \sqrt{2})}$.

58. Prove that $\sum_{-\infty}^{\infty} \frac{1}{(n+x)^2 + y^2} = \frac{\pi}{y} \frac{\sinh(2\pi y)}{\cosh(2\pi y) - \cos(2\pi x)}$.

59. Calculate the residues of the function $(1+z^2)^{-n-1}$, and shew that

$$\int_{-\infty}^{\infty} \frac{dx}{(1+x^2)^{n+1}} = \frac{1 \cdot 3 \cdot 5 \dots (2n-1)}{2 \cdot 4 \cdot 6 \dots (2n)} \pi.$$

60. Shew that $\int_0^{\infty} \frac{x^4 dx}{(1+x^2)^4} = \frac{\pi}{32}$.

61. Shew that, if $m \geq 0$, $a > 0$,

$$\int_0^{\infty} \frac{\sin mx}{x(x^2+a^2)^2} dx = \frac{\pi}{2a^4} - \frac{\pi e^{-ma}}{4a^3} \left(m + \frac{2}{a}\right).$$

62. If $-1 < R(z) < 3$, shew that

$$\int_0^{\infty} \frac{x^z}{(1+x^2)^2} dx = \frac{\pi(1-z)}{4 \cos(\frac{1}{2}\pi z)}.$$

63. If n is a positive integer, shew that

$$\int_0^{2\pi} e^{\cos \theta} \cos(n\theta - \sin \theta) d\theta = \frac{2\pi}{n!}.$$

64. If $|r| < 1$, shew that

$$\int_0^{2\pi} \frac{\cos^2 3\theta}{1 - 2r \cos 2\theta + r^2} d\theta = \frac{\pi(1-r+r^2)}{1-r}.$$

65. Shew that

$$\int_C \frac{dz}{(z-1)^2(z^2+1)} = -\frac{\pi i}{2},$$

where C denotes the circumference of the circle $x^2 + y^2 - 2x - 2y = 0$ described positively.

66. If n is a positive integer, prove that

$$P_n(\cos \theta) = \frac{(2n)!}{2^{2n-1}(n!)^2} \left\{ \cos n\theta + \frac{1 \cdot n}{1 \cdot (2n-1)} \cos(n-2)\theta \right. \\ \left. + \frac{1 \cdot 3}{1 \cdot 2} \frac{n(n-1)}{(2n-1)(2n-3)} \cos(n-4)\theta + \dots \right\}.$$

[Expand both sides of the equation

$$(1 - 2\zeta \cos \theta + \zeta^2)^{-\frac{1}{2}} = (1 - \zeta e^{i\theta})^{-\frac{1}{2}} (1 - \zeta e^{-i\theta})^{-\frac{1}{2}}$$

in powers of ζ , and equate the coefficients of ζ^n .]

67. If n is zero or a positive integer, shew that

$$(i) P_{2n+1}(0) = 0, \quad (ii) P_{2n}(0) = (-1)^n \frac{1 \cdot 3 \dots (2n-1)}{2 \cdot 4 \dots (2n)}.$$

68. Shew that

$$P_n(-\frac{1}{2}) = P_0(-\frac{1}{2}) \cdot P_{2n}(\frac{1}{2}) + P_1(-\frac{1}{2}) \cdot P_{2n-1}(\frac{1}{2}) + \dots + P_{2n}(-\frac{1}{2}) \cdot P_0(\frac{1}{2}).$$

[Expand both sides of the equation

$$(1 + \zeta^2 + \zeta^4)^{-\frac{1}{2}} = (1 + \zeta + \zeta^2)^{-\frac{1}{2}} (1 - \zeta + \zeta^2)^{-\frac{1}{2}},$$

and equate the coefficients of ζ^{2n} .]

69. OB is one diagonal of a square OABC which has the side OA on the x -axis and the side OC on the y -axis; through D(2a, 2a), the mid-point of OB, lines are drawn parallel to OA and OC so as to divide OABC into four equal squares with sides of length 2a. If w is given by the series

$$w = \frac{16}{\pi^2} \sum_{n=1}^{\infty} \sum_{m=1}^{\infty} \frac{1}{(2m-1)(2n-1)} \sin \frac{(2m-1)\pi x}{2a} \sin \frac{(2n-1)\pi y}{2a},$$

prove that

- (i) $w=0$ along each side of the four squares;
- (ii) $w=1$ within each of the two squares about the diagonal ODB;
- (iii) $w=-1$ within each of the squares about the diagonal ADC.

70. Integrate $(1 - e^{-z})/z$ round the contour consisting of the positive x and y -axes and a quadrant of an infinite circle, and shew that

$$(i) \int_0^{\infty} (1 - e^{-x}) \frac{dx}{x} = \int_0^{\infty} \frac{1 - \cos x}{x} dx;$$

$$(ii) \int_0^{\infty} \frac{\sin x}{x} dx = \frac{\pi}{2}.$$

71. If b and r are positive, and a is real, prove that

$$(i) \int_0^{\infty} e^{a \cos bx} \cos(a \sin bx) \frac{r dx}{x^2 + r^2} = \frac{\pi}{2} e^{ae-br},$$

$$(ii) \int_0^{\infty} e^{a \cos bx} \sin(a \sin bx) \frac{x dx}{x^2 + r^2} = \frac{\pi}{2} (e^{ae-br} - 1).$$

72. Shew that, if $\alpha > 0$, $m > 0$, $-1 < r < 1$,

$$(i) \int_0^{\infty} \frac{x \sin 2\alpha x}{m^2 + x^2} \frac{1 - 2r \cos 2\alpha x + r^2}{1 - 2r \cos 2\alpha x + r^2} dx = \frac{\pi}{2(e^{2\alpha m} - r)},$$

$$(ii) \int_0^{\infty} \frac{x \sin \alpha x}{m^2 + x^2} \frac{1 - 2r \cos 2\alpha x + r^2}{1 - 2r \cos 2\alpha x + r^2} dx = \frac{\pi e^{\alpha m}}{2(1+r)(e^{2\alpha m} - r)}.$$

[Integrate (i) $\frac{z}{m^2 + z^2} \frac{1}{1 - re^{2i\alpha z}}$, (ii) $\frac{z}{m^2 + z^2} \frac{e^{i\alpha z}}{1 - re^{2i\alpha z}}$.]

73. Shew that the root of the equation $z = \zeta + we^z$ which has the value ζ when $w=0$ is given by

$$z = \zeta + \sum_1^{\infty} n^{n-1} e^{n\zeta} \frac{w^n}{n!},$$

provided $|w| < |e^{-\zeta-1}|$.

74. If $z = \zeta + e \sin z$, shew that, for small values of e ,

$$(i) z = \zeta + \frac{e}{1!} \sin \zeta + \frac{e^2}{2!} \frac{d}{d\zeta} (\sin \zeta)^2 + \frac{e^3}{3!} \frac{d^2}{d\zeta^2} (\sin \zeta)^3 + \dots,$$

$$(ii) \sin z = \sin \zeta + \frac{e}{1!} \sin \zeta \cos \zeta + \frac{e^2}{2!} \frac{d}{d\zeta} (\sin^2 \zeta \cos \zeta) + \dots$$

75. If $z = \zeta + wz^{m+1}$, where $\zeta \neq 0$, and if that root of the equation is taken which has the value ζ when $w=0$, shew that

$$\log z = \log \zeta + \sum_1^{\infty} \frac{w^n}{n!} \frac{(mn+n-1)!}{(mn)!} \zeta^{mn},$$

provided $|w| < |m^m(m+1)^{-m-1}\zeta^{-m}|$.

76. If n is a positive integer, shew that

$$(i) P_n'(z) = (2n-1)P_{n-1}(z) + (2n-5)P_{n-3}(z) + (2n-9)P_{n-5}(z) + \dots,$$

$$(ii) P_n''(z) = (2n-3)(2n-1)P_{n-2}(z) + (2n-7)(4n-2)P_{n-4}(z) + (2n-11)(6n-3)P_{n-6}(z) + \dots$$

77. If n is a positive integer, shew that the n zeros of $P_n(z)$ are all real and lie between ± 1 .

[Apply Rolle's Theorem to $(x^2-1)^n$ and its derivatives.]

78. Shew that, if n is zero or a positive integer, and if $R(\zeta) > 0$,

$$\int_{-1}^1 (\cosh 2\zeta - z)^{-\frac{1}{2}} P_n(z) dz = \sqrt{2} \frac{2}{2n+1} e^{-(2n+1)\zeta}.$$

79. If $|r| < 1$, shew that

$$(i) r \cos \theta - r^2 \frac{\cos 2\theta}{2} + r^3 \frac{\cos 3\theta}{3} - \dots = \frac{1}{2} \log(1 + 2r \cos \theta + r^2),$$

$$(ii) r \sin \theta - r^2 \frac{\sin 2\theta}{2} + r^3 \frac{\sin 3\theta}{3} - \dots = \tan^{-1} \left(\frac{r \sin \theta}{1 + r \cos \theta} \right),$$

where the principal value of the inverse tangent is taken.

80. Prove that, if $0 < \theta < \pi$,

$$\cos \theta + \frac{1}{3} \cos 3\theta + \frac{1}{5} \cos 5\theta + \dots = \frac{1}{2} \log(\cot \frac{1}{2}\theta).$$

81. Prove that

$$(i) \cos \theta \cos \alpha + \frac{1}{2} \cos 2\theta \cos 2\alpha + \frac{1}{3} \cos 3\theta \cos 3\alpha + \dots \\ = -\frac{1}{4} \log \{4(\cos \theta - \cos \alpha)^2\},$$

$$(ii) \cos \theta \cos \alpha - \frac{1}{2} \cos 2\theta \cos 2\alpha + \frac{1}{3} \cos 3\theta \cos 3\alpha - \dots \\ = \frac{1}{4} \log \{4(\cos \theta + \cos \alpha)^2\},$$

unless one of the quantities $\theta - \alpha$ and $\theta + \alpha$ is an even multiple of π in case (i) or an odd multiple of π in case (ii).

82. Shew that, if $0 \leq \theta \leq 2\pi$,

$$(i) \cos \theta + \frac{1}{2^2} \cos 2\theta + \frac{1}{3^2} \cos 3\theta + \dots = \frac{1}{1^2} (3\theta^2 - 6\pi\theta + 2\pi^2),$$

$$(ii) \sin \theta + \frac{1}{2^3} \sin 2\theta + \frac{1}{3^3} \sin 3\theta + \dots = \frac{1}{1^2} (\theta^3 - 3\pi\theta^2 + 2\pi^2\theta).$$

83. If $0 \leq \theta \leq \pi$, shew that

$$(i) \frac{\cos 4\theta}{1 \cdot 2} + \frac{\cos 6\theta}{2 \cdot 3} + \frac{\cos 8\theta}{3 \cdot 4} + \dots = \cos 2\theta - \left(\frac{\pi}{2} - \theta\right) \sin 2\theta + \sin^2\theta \log(4 \sin^2\theta),$$

$$(ii) \frac{\sin 4\theta}{1 \cdot 2} + \frac{\sin 6\theta}{2 \cdot 3} + \frac{\sin 8\theta}{3 \cdot 4} + \dots = \sin 2\theta - (\pi - 2\theta) \sin^2\theta - \sin \theta \cos \theta \log(4 \sin^2\theta).$$

84. If n is a positive integer, and if $|z| < 1$, shew that

$$\frac{z}{1(n+1)} + \frac{z^2}{2(n+2)} + \frac{z^3}{3(n+3)} + \dots = \frac{1}{nz^n} \left\{ (1-z^n) \log(1-z) + \left(z + \frac{z^2}{2} + \frac{z^3}{3} + \dots + \frac{z^n}{n} \right) \right\}.$$

Deduce that

$$\frac{1}{1(n+1)} + \frac{1}{2(n+2)} + \frac{1}{3(n+3)} + \dots = \frac{1}{n} \left(1 + \frac{1}{2} + \frac{1}{3} + \dots + \frac{1}{n} \right).$$

85. If $0 \leq \theta \leq \pi$, shew that

$$\frac{\pi}{8} \theta(\pi - \theta) = \frac{\sin \theta}{1^3} + \frac{\sin 3\theta}{3^3} + \frac{\sin 5\theta}{5^3} + \dots$$

86. If $-\pi/2 \leq \theta \leq \pi/2$, shew that

$$\frac{\pi\theta}{8} \left(\frac{\pi^2}{4} - \frac{\theta^2}{3} \right) = \sin \theta - \frac{\sin 3\theta}{3^4} + \frac{\sin 5\theta}{5^4} - \dots$$

87. If $-\pi/2 \leq \theta \leq \pi/2$, shew that

$$\frac{\cos 3\theta}{1 \cdot 3 \cdot 5} - \frac{\cos 5\theta}{3 \cdot 5 \cdot 7} + \frac{\cos 7\theta}{5 \cdot 7 \cdot 9} - \dots = \frac{\pi}{8} \cos^2\theta - \frac{1}{3} \cos \theta.$$

88. Shew that the series $\sum_{n=1}^{\infty} \frac{e^{-nz}}{n^2}$

represents a continuous function in the part of the z -plane for which $\text{I}(z) \leq 0$, and that the function is holomorphic at all points below the real axis.

89. Prove that $y = \frac{1}{3} + \frac{2}{\pi^2} \left(\cos \pi x - \frac{\cos 2\pi x}{2^2} + \frac{\cos 3\pi x}{3^2} - \dots \right)$

represents a series of equal and similar parabolic arcs standing in contact along the x -axis.

90. Prove that $\sum_{m=-\infty}^{\infty} \sum_{n=-\infty}^{\infty} \frac{1}{(m^2 + a^2)(n^2 + b^2)} = \frac{\pi^2}{ab} \coth \pi a \coth \pi b.$

91. If $-1 < R(\alpha) < 1$, shew that

$$\int_0^{\infty} \frac{\sinh \alpha x}{\cosh x} \frac{dx}{x} = \log \cot \left\{ \frac{\pi}{4} (1 - \alpha) \right\}.$$

Deduce that, if λ is real,

$$\int_0^{\infty} \frac{\sin \lambda x}{\cosh x} \frac{dx}{x} = 2 \tan^{-1} \left(\tanh \frac{\pi \lambda}{4} \right).$$

92. Prove that $\lim_{n \rightarrow \infty} \left(1 + \frac{1}{3} + \frac{1}{5} + \dots + \frac{1}{2n-1} - \frac{1}{2} \log n \right) = \log 2 + \frac{1}{2} \gamma$.

93. Shew that

$$\sum_{n=1}^{\infty} \frac{1}{n(4n^2-1)} = 2 \log 2 - 1, \quad (\text{ii}) \quad \lim_{n \rightarrow \infty} \sum_{r=0}^{n-1} \frac{1}{n+r} = \log 2.$$

94. Shew that

$$\frac{1}{e^z + 1} = \frac{1}{2} - B_1(2^2 - 1) \frac{z}{2!} + B_2(2^4 - 1) \frac{z^3}{4!} - B_3(2^6 - 1) \frac{z^5}{6!} + \dots$$

[Use the identity $(e^z - 1)^{-1} - 2(e^{2z} - 1)^{-1} = (e^z + 1)^{-1}$.]

95. Prove that $\int_0^{\infty} \frac{x^{2n-1} dx}{\sinh x} = \frac{2^{2n} - 1}{2n} B_n \pi^{2n}$.

[Shew that $e^{-a} - e^{-2a} + \dots + (-1)^{n-1} e^{-na} = \frac{-1}{2\pi i} \int_C \frac{\pi}{\sin \pi z} e^{-az} dz$, where C is the contour of Fig. 58, and use Ex. 94.]

96. Shew that (i) $\frac{z}{2} \cot \frac{z}{2} = 1 - B_1 \frac{z^2}{2!} - B_2 \frac{z^4}{4!} - B_3 \frac{z^6}{6!} - \dots$,

$$(\text{ii}) \quad \log \left\{ \frac{z}{2 \sin \left(\frac{1}{2} z \right)} \right\} = \frac{B_1}{2} \frac{z^2}{2!} + \frac{B_2}{4} \frac{z^4}{4!} + \frac{B_3}{6} \frac{z^6}{6!} + \dots$$

97. Prove that (i) $\prod_{n=2}^{\infty} \left\{ \left(1 - \frac{1}{n} \right) e^{\frac{1}{n}} \right\} = e^{\gamma-1}$, (ii) $\prod_{n=2}^{\infty} \left(\frac{n^3 - 1}{n^3 + 1} \right) = \frac{2}{3}$.

98. If $R(n) > 0$, shew that

$$\begin{aligned} \int_0^{\frac{\pi}{2}} (\cos \theta)^{n-1} \cos(\alpha \tan \theta) \cos(n+1)\theta d\theta \\ = \int_0^{\frac{\pi}{2}} (\cos \theta)^{n-1} \sin(\alpha \tan \theta) \sin(n+1)\theta d\theta \\ = \frac{\pi \alpha^n}{\Gamma(n)} \frac{e^{-\alpha}}{2}. \end{aligned}$$

[Use Exs. VIII. 6.]

99. Shew that $\psi(x) - \psi(y) = \sum_0^{\infty} \left(\frac{1}{n+y+1} - \frac{1}{n+x+1} \right)$.

100. Shew that, if m is a positive integer,

$$\psi(mz) = \frac{1}{m} \left\{ \psi \left(z - \frac{m-1}{m} \right) + \psi \left(z - \frac{m-2}{m} \right) + \dots + \psi(z) \right\} + \log m.$$

101. Shew that

$$(\text{i}) \quad \psi'(z) = \sum_{n=1}^{\infty} \frac{1}{(z+n)^2}, \quad (\text{ii}) \quad \psi'(0) = \frac{\pi^2}{6}, \quad (\text{iii}) \quad \psi' \left(-\frac{1}{2} \right) = \frac{\pi^2}{2}.$$

102. Prove, by using the equation

$$\frac{1}{\cosh x} = 2 \left\{ e^{-x} - e^{-3x} + e^{-5x} - \dots + (-1)^{n-1} e^{-(2n-1)x} + (-1)^n \frac{e^{-(2n+1)x}}{1 + e^{-2x}} \right\},$$

that, if $R(c) > -1$,

$$\int_0^\infty \frac{e^{-cx}}{\cosh x} dx = \frac{1}{2} \left\{ \psi\left(\frac{c-1}{4}\right) - \psi\left(\frac{c-3}{4}\right) \right\}.$$

103. Shew that, if $R(z) > -1$ and $R(n) > 1$,

$$\frac{1}{(z+1)^n} + \frac{1}{(z+2)^n} + \frac{1}{(z+3)^n} + \dots = \frac{1}{\Gamma(n)} \int_0^\infty \frac{e^{-tz} t^{n-1}}{e^t - 1} dt.$$

104. If $R(a) > 0$, shew that

$$\frac{\Gamma(z)\Gamma(a)}{\Gamma(z+a)} = \frac{1}{z} + \frac{1-a}{1!} \frac{1}{z+1} + \frac{(1-a)(2-a)}{2!} \frac{1}{z+2} + \dots$$

105. Shew that, if $R(z) > -1$,

$$\psi(z) + \gamma = \int_0^\infty \left\{ \frac{1}{1+t} - \frac{1}{(1+t)^{z+1}} \right\} \frac{dt}{t}.$$

106. Shew that, if $R(n) > 1$,

$$\int_0^{\frac{\pi}{2}} \cos(k\phi)(\cos \phi)^n d\phi = \frac{n(n-1)}{n^2 - k^2} \int_0^{\frac{\pi}{2}} \cos(k\phi)(\cos \phi)^{n-2} d\phi.$$

If n is zero or a positive integer, prove, by considering the cases n even and n odd separately, that

$$\int_0^{\frac{\pi}{2}} \cos(k\phi)(\cos \phi)^n d\phi = \frac{(-1)^n n! \sin\left\{(n+k)\frac{\pi}{2}\right\}}{2^{n+1} \left(\frac{n+k}{2}\right) \left(\frac{n+k}{2} - 1\right) \dots \left(\frac{n+k}{2} - n\right)}.$$

Deduce that, if n is zero or a positive integer,

$$\frac{2^{n+1}}{\pi} \int_0^{\frac{\pi}{2}} \cos(k\phi)(\cos \phi)^n d\phi = \frac{n!}{\Gamma\left(\frac{n+k}{2} + 1\right) \Gamma\left(\frac{n-k}{2} + 1\right)}.$$

107. Evaluate $\int_{z_0}^{\zeta} \sqrt[3]{z} dz$, where $z_0 = ae^{\frac{\pi i}{4}}$, $\zeta = ae^{\frac{5\pi i}{4}}$, and the path of integration is a semi-circle of centre the origin and radius a described positively. Also find the values of the integrals which have z_0 as initial point, and whose paths are: (i) a complete circumference of the circle; (ii) two circumferences; (iii) three circumferences. What is the shortest non-zero path from z_0 along the circumference which makes the integral zero?

Ans. $-\frac{3}{4}\sqrt{3}ia^{\frac{4}{3}}$; (i) $-\frac{3}{4}a^{\frac{4}{3}}(1 + e^{\frac{\pi i}{3}})$, (ii) $-\frac{3}{4}a^{\frac{4}{3}}(e^{\frac{2\pi i}{3}} + e^{\frac{\pi i}{3}})$, (iii) 0; three-fourths of a circumference.

108. Prove that $\int_0^\infty \frac{dx}{\sqrt[4]{(1+x^2)(1+k^2x^2)}} = F\left(k', \frac{\pi}{2}\right)$.

109. Shew that all elliptic integrals $\int R(x, \sqrt{X}) dx$, where $R(x, y)$ is rational in x and y , and X is a cubic in x with no repeated factors, can be expressed in terms of integrals of the three types

$$\int \frac{dy}{\sqrt{(4y^3 - g_2y - g_3)}}, \quad \int \frac{y dy}{\sqrt{(4y^3 - g_2y - g_3)}}, \quad \int \frac{dy}{(y-a)\sqrt{(4y^3 - g_2y - g_3)}}.$$

110. Establish the identity

$$\begin{vmatrix} 1 & \wp(z_0) & \wp'(z_0) & \dots & \wp^{(n-1)}(z_0) \\ 1 & \wp(z_1) & \wp'(z_1) & \dots & \wp^{(n-1)}(z_1) \\ \dots & \dots & \dots & \dots & \dots \\ 1 & \wp(z_n) & \wp'(z_n) & \dots & \wp^{(n-1)}(z_n) \end{vmatrix} = (-1)^{1n(n-1)} 1! 2! \dots n! \frac{\sigma(z_0 + z_1 + \dots + z_n) \prod \sigma(z_\lambda - z_\mu)}{\sigma^{n+1}(z_0) \dots \sigma^{n+1}(z_n)},$$

where the product is taken for all integral values of λ and μ from 0 to n , with the restriction $\lambda < \mu$.

111. Shew that

$$\begin{vmatrix} \wp'(u) & \wp''(u) & \dots & \wp^{(n)}(u) \\ \wp''(u) & \wp'''(u) & \dots & \wp^{(n+1)}(u) \\ \dots & \dots & \dots & \dots \\ \wp^{(n)}(u) & \wp^{(n+1)}(u) & \dots & \wp^{(2n-1)}(u) \end{vmatrix} = (-1)^{n^2} (1! 2! \dots n!)^2 \frac{\sigma\{(n+1)u\}}{\{\sigma(u)\}^{(n+1)^2}}.$$

112. Shew that $2\zeta(2u) - 4\zeta(u) = \frac{\wp''(u)}{\wp'(u)}.$

113. Shew that $\wp''(u) = 6 \frac{\sigma(u+v)\sigma(u-v)\sigma(u+w)(u-w)}{\sigma^4(u)\sigma^2(v)\sigma^2(w)},$

where $\wp(v) = (\frac{1}{2}g_2)^{\frac{1}{2}}$, $\wp(w) = -(\frac{1}{2}g_2)^{\frac{1}{2}}$.

114. Prove that

$$\int \frac{du}{\wp(u) - \wp(v)} = -\frac{1}{\wp'(v)} \left\{ \log \frac{\sigma(u+v)}{\sigma(u-v)} - 2u\zeta(v) \right\} + C.$$

115. The function $\wp(u)$ has a real period $2\omega_1$, and an imaginary period $2\omega_2$, where $\omega_2 = \frac{i\omega_1}{\pi} \log \left(\frac{b}{a} \right)$, a and b being real and positive, and such that $a < b$.

Shew that, if $z = \wp \left(\frac{i\omega_1}{\pi} \log \frac{\zeta}{a} \right)$, the annulus in the ζ -plane bounded by the circles $|\zeta| = a$ and $|\zeta| = b$ and a barrier along the positive real axis, corresponds to the entire z -plane. Shew also that only one point of the annulus corresponds to each point of the z -plane.

116. Prove that

$$\operatorname{sn}(u+v) - \operatorname{sn}(u-v) = \frac{1}{k} \frac{\partial}{\partial u} \log \left(\frac{1 + ks_1s_2}{1 - ks_1s_2} \right).$$

117. Shew that $\operatorname{Lim}_{u \rightarrow 0} \frac{1 - \operatorname{cn}(1 - \operatorname{cn} u)}{u^4} = \frac{1}{8}.$

118. If six of the nine points in which the cubic $y^2 = 4x^3 - g_2x - g_3$ is cut by a second cubic lie on a conic, shew that the other three points lie on a straight line.

119. If a conic passes through four fixed points on the cubic

$$y^2 = 4x^3 - g_2x - g_3,$$

shew that the straight line joining the two variable points of intersection passes through a fixed point on the cubic.

120. Solve the equation $w'' + az^2w = 0$.

$$\text{Ans. } w_1 = 1 - \frac{a}{3 \cdot 4} z^4 + \frac{a^2}{3 \cdot 4 \cdot 7 \cdot 8} z^8 - \dots, \quad w_2 = z - \frac{a}{4 \cdot 5} z^5 + \frac{a^2}{4 \cdot 5 \cdot 8 \cdot 9} z^9 - \dots$$

121. Solve the equation $w'' + 2zw' + w = 0$.

$$\begin{aligned} \text{Ans. } w_1 &= 1 - \frac{1}{3!} z^3 + \frac{1 \cdot 7}{6!} z^6 - \frac{1 \cdot 7 \cdot 13}{9!} z^9 + \dots, \\ w_2 &= \frac{1}{1!} z - \frac{3}{4!} z^4 + \frac{3 \cdot 9}{7!} z^7 - \frac{3 \cdot 9 \cdot 15}{10!} z^{10} + \dots, \\ w_3 &= \frac{1}{2!} z^2 - \frac{5}{5!} z^5 + \frac{5 \cdot 11}{8!} z^8 - \frac{5 \cdot 11 \cdot 17}{11!} z^{11} + \dots \end{aligned}$$

122. If n is a positive integer, shew that all the zeros of $P_n(z)$ are simple zeros.

[By differentiating Legendre's Equation it can be shewn that if $P_n(z)$ has a zero of the second order, $\frac{d^k}{dz^k} P_n(z) = 0$ for all positive integral values of k .]

123. Find that integral of the equation

$$2zw'' + 3w' - 2w = 0$$

which has the value unity when $z = 0$.

$$\text{Ans. } w = \frac{1}{2i\sqrt{z}} \sin(2i\sqrt{z}).$$

Find regular integrals in the neighbourhood of $z = 0$ for the equations of Examples 124-128.

124. $4z^2w'' + 4zw' - (z+1)w = 0$.

$$\begin{aligned} \text{Ans. } w_1 &= z^{\frac{1}{2}} \left(1 + \frac{z}{2 \cdot 4} + \frac{z^2}{2 \cdot 4^2 \cdot 6} + \frac{z^3}{2 \cdot 4^2 \cdot 6^2 \cdot 8} + \dots \right), \\ w_2 &= w_1 \log z + 4z^{-\frac{1}{2}} \left\{ 1 - \frac{z}{2^2} - \frac{z^2}{2^2 \cdot 4} \left(\frac{2}{2} + \frac{1}{4} \right) - \frac{z^3}{2^2 \cdot 4^2 \cdot 6} \left(\frac{2}{2} + \frac{2}{4} + \frac{1}{6} \right) - \dots \right\}. \end{aligned}$$

125. $z^2w'' - (z^2 + 4z)w' + 4w = 0$.

$$\text{Ans. } w_1 = z^4 e^z, \quad w_2 = w_1 \log z + 2z - z^2 + z^3 - \sum_1 \frac{z^{n+4}}{n!} \left(\frac{1}{1} + \frac{1}{2} + \dots + \frac{1}{n} \right).$$

126. $z^2(z+1)w'' - z^2w' + \frac{1}{4}(3z+1)w = 0$.

$$\text{Ans. } w_1 = z^{\frac{1}{2}}, \quad w_2 = z^{\frac{1}{2}} \log z + z^{\frac{3}{2}}.$$

127. $2z^2(2-z)w'' - z(4-z)w' + (3-z)w = 0$.

$$\text{Ans. } w_1 = z^{\frac{1}{2}}, \quad w_2 = (z - \frac{1}{2}z^2)^{\frac{1}{2}}.$$

128. $z^2(1-z)w'' + z(5z-4)w' + (6-9z)w = 0$.

$$\text{Ans. } w_1 = z^3, \quad w_2 = w_1 \log z + z^2.$$

129. If n is zero or a positive integer, shew that

$$\frac{d^{n+1} Q_n(z)}{dz^{n+1}} = - \frac{(-2)^n \Gamma(n+1)}{(z^2-1)^{n+1}}.$$

130. Shew that, for all values of n ,

$$\begin{aligned} \text{(i) } nP'_{n+1}(z) + (n+1)P'_{n-1}(z) &= (2n+1)zP'_n(z), \\ \text{(ii) } nQ'_{n+1}(z) + (n+1)Q'_{n-1}(z) &= (2n+1)zQ'_n(z). \end{aligned}$$

131. Shew that, for all values of n ,

$$(i) (1-z^2)P'_n(z) = nP_{n-1}(z) - nzP_n(z),$$

$$(ii) (1-z^2)P'_{n-1}(z) + nP_n(z) - nzP_{n-1}(z) = 0,$$

$$(iii) (1-z^2)Q'_n(z) = nQ_{n-1}(z) - nzQ_n(z),$$

$$(iv) (1-z^2)Q'_{n-1}(z) + nQ_n(z) - nzQ_{n-1}(z) = 0.$$

132. If n is zero or a positive integer, shew that

$$Q_n(z) = \frac{1}{2} P_n(z) \log \left(\frac{z+1}{z-1} \right) - W_{n-1}(z),$$

where $W_{n-1}(z)$ is a polynomial of degree $n-1$.

$$\left[\text{In Ex. 1, § 90, write } Q_n(z) = \frac{1}{2} \int_{-1}^1 \frac{P_n(z)}{z-\xi} d\xi - \frac{1}{2} \int_{-1}^1 \frac{P_n(z) - P_n(\xi)}{z-\xi} d\xi. \right]$$

133. With the notation of Example 132, shew that

$$W_{n-1}(z) = \frac{2n-1}{1 \cdot n} P_{n-1}(z) + \frac{2n-5}{3(n-1)} P_{n-3}(z) + \dots$$

[Substitute the expression obtained for $Q_n(z)$ in Ex. 132 in Legendre's Equation, put $W_{n-1}(z) = a_1 P_{n-1}(z) + a_3 P_{n-3}(z) + \dots$, and use Example 76.]

134. Shew that

$$\int_z^1 P_m(z) P_n(z) dz = \frac{m P_n(z) P_{m-1}(z) - n P_m(z) P_{n-1}(z) - (m-n) z P_m(z) P_n(z)}{(m-n)(m+n+1)};$$

deduce that, if m and n are positive integers, both odd or both even,

$$\int_0^1 P_m(z) P_n(z) dz = 0,$$

while if m is an even and n an odd integer,

$$\int_0^1 P_m(z) P_n(z) dz = (-1)^{\frac{1}{2}(m+n+1)} \frac{m! n!}{2^{m+n-1} (m-n)(m+n+1) \left(\frac{m}{2}!\right)^2 \left(\frac{n-1}{2}!\right)^2}$$

[Cf. proof of Exs. XIV. 5, and use Ex. 131.]

135. If m and n are integers such that $n \geq 0$, $m \leq n$, shew that

$$P_n^{-m}(z) = \frac{(z^2-1)^{-\frac{1}{2}n}}{2^n \cdot n!} \frac{d^{n-m}}{dz^{n-m}} (z^2-1)^n.$$

136. Prove that, if $R(n) > R(m) > -1$,

$$J_n(z) = \frac{2}{\Gamma(n-m)} \left(\frac{z}{2}\right)^{n-m} \int_0^1 u^{m+1} (1-u^2)^{n-m-1} J_m(zu) du,$$

and deduce the results:

$$(i) J_n(z) = \frac{2}{\sqrt{\pi} 2^n \Gamma(n+\frac{1}{2})} \int_0^1 (1-u^2)^{n-\frac{1}{2}} \cos zu du, \text{ where } R(n+\frac{1}{2}) > 0;$$

$$(ii) \frac{\sin z}{z} = \int_0^{\frac{\pi}{2}} J_0(z \sin \theta) \sin \theta d\theta.$$

[Expand $J_m(zu)$ in powers of u , and integrate.]

137. Solve the equation $zw'' + (n+1)w' - w = 0$.

$$\text{Ans. } w_1 = z^{-\frac{n}{2}} J_n(2i\sqrt{z}), \quad w_2 = z^{-\frac{n}{2}} G_n(2i\sqrt{z}).$$

138. Shew that, if n is an odd positive integer,

$$\frac{z}{2} \{ J_n(z) + (-1)^{\frac{n-3}{2}} J_1(z) \} = \sum_{r=1}^{\frac{n-1}{2}} (-1)^{r-1} (n-2r+1) J_{n-2r+1}(z).$$

[Use the formula $\frac{2n}{z} J_n(z) = J_{n-1}(z) + J_{n+1}(z)$.]

139. If n is an integer, shew that

$$J_n(z) = \frac{1}{\pi i^{2n}} \int_0^\pi e^{-iz \cos \phi} \cos n\phi \, d\phi.$$

[In **Exs. XIV.**, 14, put $\zeta = e^{i\theta}$, and $\theta = \phi - \pi/2$.]

140. Prove that
$$z^2 = 2 \sum_{n=1}^{\infty} (2n)^2 J_{2n}(z).$$

[Differentiate the equation $e^{\frac{1}{2}z(\zeta-1/\zeta)} = \sum_{-\infty}^{\infty} J_n(z) \zeta^n$ with regard to ζ , multiply by ζ , differentiate again, and put $\zeta=1$.]

141. Prove that (i) $\cos x = J_0(x) - 2J_2(x) + 2J_4(x) - \dots$;

(ii) $\sin x = 2J_1(x) - 2J_3(x) + 2J_5(x) - \dots$.

[In **Exs. XIV.**, 14, put $\zeta = i$.]

142. Shew that (i) $J_{\frac{3}{2}}(z) = \sqrt{\left(\frac{2}{\pi z}\right)} \left\{ \frac{\sin z}{z} - \cos z \right\}$;

(ii) $J_{\frac{5}{2}}(z) = \sqrt{\left(\frac{2}{\pi z}\right)} \left\{ \sin z \left(\frac{3}{z^2} - 1\right) - \frac{3}{z} \cos z \right\}$;

(iii) $J_{-\frac{3}{2}}(z) = -\sqrt{\left(\frac{2}{\pi z}\right)} \left\{ \frac{\cos z}{z} + \sin z \right\}$;

(iv) $J_{-\frac{5}{2}}(z) = \sqrt{\left(\frac{2}{\pi z}\right)} \left\{ \cos z \left(\frac{3}{z^2} - 1\right) + \frac{3}{z} \sin z \right\}$.

143. Shew that

$$(i) \, G_{\frac{1}{2}}(z) = \sqrt{\left(\frac{\pi}{2z}\right)} e^{iz}; \quad (ii) \, G_{-\frac{1}{2}}(z) = i \sqrt{\left(\frac{\pi}{2z}\right)} e^{iz}.$$

144. Shew that, if p is a positive integer,

$$(i) \, z^{-n-p} J_{n+p}(z) = (-2)^p \frac{d^p}{d(z^2)^p} \{ z^{-n} J_n(z) \};$$

$$(ii) \, z^{-n-p} J_{n-p}(z) = 2^p \frac{d^p}{d(z^2)^p} \{ z^n J_n(z) \};$$

$$(iii) \, z^{-n-p} G_{n+p}(z) = (-2)^p \frac{d^p}{d(z^2)^p} \{ z^{-n} G_n(z) \};$$

$$(iv) \, z^{-n-p} G_{n-p}(z) = 2^p \frac{d^p}{d(z^2)^p} \{ z^n G_n(z) \}.$$

[Use **Exs. XIV.**, 11.]

145. If n is a positive integer, shew that

$$(i) z^{-n-1} J_{n+\frac{1}{2}}(z) = (-2)^n \sqrt{\left(\frac{2}{\pi}\right)} \frac{d^n}{d(z^2)^n} \left(\frac{\sin z}{z}\right);$$

$$(ii) z^{-n-1} G_{n+\frac{1}{2}}(z) = (-2)^n \sqrt{\left(\frac{\pi}{2}\right)} \frac{d^n}{d(z^2)^n} \left(\frac{e^z}{z}\right);$$

$$(iii) z^{-n} J_n(z) = (-2)^n \frac{d^n}{d(z^2)^n} J_0(z).$$

146. Prove that

$$J_m(z) J_n(z) = \sum_{\nu=0}^{\infty} \frac{(-1)^\nu}{\Pi(m+\nu)\Pi(n+\nu)} \cdot \frac{\Pi(m+n+2\nu)}{\Pi(\nu)\Pi(m+n+\nu)} \left(\frac{z}{2}\right)^{m+n+2\nu}$$

[Shew that the coefficient of $\left(\frac{z}{2}\right)^{m+n+2\nu}$ in the product is

$$\frac{1}{\Gamma(\nu+1)\Gamma(m+\nu+1)\Gamma(n+1)} F(-\nu, -m-\nu, n+1, 1),$$

and apply Gauss's Theorem.]

147. Shew that, if n is zero or a positive integer,

$$\frac{2}{\pi} \int_0^\pi J_n(2z \cos \phi) \cos(k\phi) d\phi = J_{n+\frac{k}{2}}(z) J_{\frac{n-k}{2}}(z).$$

[Expand $J_n(2z \cos \phi)$ in powers of $\cos \phi$, and use Examples 106 and 146.]

148. If x and u are real, prove that

$$\int_0^\infty J_1(xu) dx = \frac{1}{u}.$$

[Use the relation $\frac{dJ_0(xu)}{dx} = -uJ_1(xu)$.]

149. If x is real, and $R(n) > \frac{1}{2}$, prove that

$$\int_0^x \frac{J_n(x)}{x^{n-1}} dx = \frac{1}{2^{n-1} \Gamma(n)}.$$

[Use **Exs. XIV.**, 11.]

150. If a and b are positive constants, prove that

$$\int_0^\infty \sin(ax) J_0(bx) \frac{dx}{x} = \begin{cases} \frac{\pi}{2}, & \text{if } a \geq b, \\ \sin^{-1}\left(\frac{a}{b}\right), & \text{if } a \leq b. \end{cases}$$

[Put $J_0(bx) = \frac{1}{\pi} \int_0^\pi \cos(bx \cos \phi) d\phi$ (**Exs. XIV.**, 18), and change the order of integration.]

151. If $R(b \pm ia) > 0$, shew that

$$\int_0^\infty e^{-bx} J_0(ax) dx = \frac{1}{\sqrt{(a^2 + b^2)}}.$$

[Put $J_0(ax) = \frac{1}{\pi} \int_0^\pi \cos(ax \cos \phi) d\phi$, and change the order of integration; or, expand $J_0(ax)$ in powers of x , and integrate term by term (cf. Bromwich, *Infinite Series*, § 176, B).]

152. Shew that, if $R(2n+1) > 0$, and $R(b \pm ia) > 0$,

$$(i) \int_0^{\infty} J_n(ax) e^{-bx} x^n dx = \frac{\Gamma(n + \frac{1}{2})}{\sqrt{\pi}} \frac{(2a)^n}{(a^2 + b^2)^{n + \frac{1}{2}}};$$

$$(ii) \int_0^{\infty} J_n(ax) e^{-bx} x^{n+1} dx = \frac{2\Gamma(n + \frac{3}{2})}{\sqrt{\pi}} \frac{b(2a)^n}{(a^2 + b^2)^{n + \frac{3}{2}}}.$$

[For (i) use the substitution given in **Exs. XIV.**, 18, for $J_n(ax)$, and change the order of integration; after the first integration expand $(b + ia \cos \phi)^{-2n-1}$ in powers of $\cos \phi$, and integrate again; or, expand $J_n(ax)$ in powers of x , and integrate term by term. For (ii), differentiate (i) with regard to b .]

153. Prove that $\frac{1}{\pi} \int_0^{\pi} e^{ix \cos \phi} \cos(y \sin \phi) d\phi = J_0(\sqrt{x^2 + y^2})$.

[Expand $\cos(y \sin \phi)$ in powers of $\sin \phi$, and apply § 99, Cor., Example 145, (iii), and Taylor's Theorem.]

INDEX.

The numbers refer to the pages.

- Abel's test for convergence of series, 80.
theorem on continuity of series, 125.
- Addition of complex numbers, 1, 3.
- Amplitude, 2, 4.
of a function, variation of, 11-17.
principal value of, 2, 4.
- Argand diagram, 2.
- Argument, 2.
- Asymptotic expansions, 136.
(*See under* Bessel, Euler, Gamma function.)
- Bernoulli numbers, 132.
- Bessel function, 236.
Bessel function $G_n(z)$, 240.
addition theorem for, 254.
as a contour integral, 267.
asymptotic expansion of, 271.
in terms of Bessel functions of first and second kinds, 240.
recurrence formulae for, 241.
- Bessel function of first kind, 237.
addition theorem for, 254.
as a contour integral, 267, 268, 270.
as a function of its order, 239.
asymptotic expansions of, 273, 274.
recurrence formulae for, 239.
zeros of, 241, 274.
- Bessel function of second kind, 238, 239.
- Bessel functions, relations between, 241.
- Bessel's equation, 236, 266.
- Beta function, 144, 145.
- Binomial theorem, 90.
- Branch of function, 13.
- Branch point, 14, 39.
of an integral, 257.
- Cauchy's integral theorem, 51, 54.
residue theorem, 57.
- Circular functions, 33, 83, 90.
- Coefficients, undetermined, 96.
- Collinearity of points on cubic, 197.
- Complex numbers, 1.
geometrical representation of, 1.
operations with, 1-5.
- Complex variable, 7.
function of a , 7.
path of variation of a , 7.
- Conformal representation, 37.
- Congruent points, 179, 180.
- Conjugate numbers, 1, 2.
- Connected region, 30.
- Continuation, analytical, 122, 208.
of hypergeometric function, 153, 156, 249.
of integral of diff. equation, 213.
theorems on, 123, 124.
- Continuity, 23, 24.
Abel's theorem on, 125.
of series, 92.
uniform, 24-26.
- Convergence of infinite product, 107, 108.
unconditional, 107.
- Convergence of sequence, 42.
uniform, 42.
- Convergence of series, 76.
absolute, 76, 78.
circle of, 80.
of a double series, 78.
of power series, 80, 82, 95.
radius of, 80.
ratio tests for, 77.
uniform, 92.
- Coordinates, polar, 2, 29.
rectangular, 2.
- Cross-cut, 30.
- Derivative, 26, 28.
of function of a function, 30.
of holomorphic function, 28, 70.
of inverse function, 30.
partial, 31, 70.

The numbers refer to the pages.

- Determinant of fundamental system, 216, 223.
 index of, 224.
- Differential equation, homogeneous linear, 209.
 coefficients of, 210.
 construction of, 216.
 domain of ordinary point of, 210.
 dominant equation, 210.
 Frobenius' method of solution, 225.
 fundamental equation, 220.
 fundamental system, 215, 257.
 indicial equation, 225.
 integrals of, 210.
 of the first order, 210.
 of the second order, 210.
 ordinary point of, 210.
 singularity of, 210.
 solutions of, 210.
- Differentiation, 26, 28, 29.
 of series, 93.
 under integral sign, 44, 69, 138.
- Discontinuity, removable, 23.
- Division of complex numbers, 1, 4.
- Domain of a point, 38, 210.
- Elements of a function, 208.
- Elliptic function, 180.
 order of, 181, 182.
 poles of, 180 to 183.
 zeros of, 182.
 (*See under* Jacobian and Weierstrassian functions.)
- Elliptic integrals, 169.
 reduction of, 170-173.
 transformation of, 170-174.
 (*See also* Legendre's and Weierstrass's elliptic integrals.)
- Equations, roots of, 16, 69.
- Euler's constant, 135.
 asymptotic expansion of, 134.
- Euler's definition of gamma function, 141.
- Expansion, Lagrange's, 119.
- Expansion of functions in series of fractions, 103, 105.
- Exponential function, 32, 90.
- Fourier series, 86.
- Frobenius' method of solving linear diff. equations, 225.
 indicial equation, 225.
 solutions free from logarithms, 228.
 uniform convergence of series with regard to index, 227.
- Fuchsian type, equations of, 243.
 sum of indices a constant, 243, 244.
- Function, analytic, 29, 208.
 conjugate, 31.
 continuous, 23.
 dominant, 210.
 doubly-periodic, 179.
 elements of a, 208.
 even, 33, 97.
 geometrical representation of a, 7, 10.
 holomorphic, 29, 52, 93.
 initial value of, 10.
 integral, 88.
 integrals of, 48.
 inverse, 30.
 limit of, 22.
 meromorphic, 39, 40, 89, 160.
 multiform or multiple-valued, 7, 161, 209.
 odd, 33, 97.
 of a complex variable, 7.
 of a function, 24, 30, 49.
 of two complex variables, 69, 137.
 of two real variables, 26.
 periodic, 32, 86.
 periodic, of the second kind, 187.
 periodic, of the third kind, 189.
 rational, 89.
 rational integral, 88.
 region of existence of, 7.
 regular, 29.
 simply-periodic, 86.
 single-valued, 7, 209.
 transcendental integral, 88.
 uniform, 7, 209.
 uniform, classification of, 88.
- Fundamental equation, 220.
- Fundamental system of integrals, 215, 257.
 associated with fundamental equation, 220.
 in neighbourhood of singularity, 219.
- Fundamental theorem of algebra, 68, 69.
- Gamma function, 109, 139, 141.
 asymptotic expansion of, 146.
 duplication formula for, 145.
 Euler's definition of, 141.
 expression as a contour integral, 143.
 Gauss's definition of, 141.
 the derived function $\Psi(z)$, 141.
- Gauss's differential equation, 228, 258.
 function $\Pi(z)$, 141.
 sum, 117.
 theorem, 144.

The numbers refer to the pages.

- Geometrical representation. (*See under*
Complex numbers, Functions and
Transformations.)
- Green's theorem, 45.
- Gregory's series, 84.
- Harmonic functions, 31.
- Harmonics, cylindrical, 236.
spherical, etc., 249.
- Hyperbolic functions, 33, 90.
- Hypergeometric equation, 228, 258.
relations between integrals of, 249.
the twenty-four integrals of, 247.
- Hypergeometric function, 77, 151, 229,
246, 247.
analytical continuation of, 153, 156,
249.
as a contour integral, 259.
- Hypergeometric series, 77, 78, 144.
convergence of, 77.
- Identities, 83.
- Image of point, 9.
- Indented contour, 65.
- Indicial equation, 225.
fundamental system, 227.
- Infinity, point at, 9.
continuity at, 23.
integral at, 51, 137, 139.
integrals of diff. equ. at, 212, 213, 224.
loop about, 162, 168.
residue at, 58, 96.
singularity at, 38, 39.
- Integrals, contour, 59, 97, 113.
convergent, 136.
curvilinear, 42.
definite, 48.
double, 69, 138.
elliptic, 169.
evaluation of definite, 59, 97, 113.
finite moduli of definite, 50.
Fresnel, 62.
indefinite, 53.
independent of paths, 52.
limiting values of definite, 60, 63,
113, 115.
of holomorphic functions, 50-52.
of meromorphic functions, 160.
of multiform functions, 161.
principal values of, 65.
uniformly convergent, 137.
with infinite paths, 51, 137, 139.
- Integrals of differential equation, 210.
analytical continuation of, 213.
at infinity, 212, 213.
- Integrals of differential equation,
existence of, 210.
fundamental system of, 215.
in form of infinite series, 213.
initial values of, 210.
linearly independent, 215.
- Integrals of diff. equ. in form of definite
integrals, 255, 266.
branch points of, 257.
fundamental system of, 257.
- Integrals of diff. equ. near a singularity,
219.
at infinity, 224.
fundamental system of, 219.
index of, 222.
regular, 222.
- Integrand, infinite, 136, 139.
- Integration, change of order of, 69, 138.
of series, 93.
partial, 53.
under integral sign, 69, 138.
- Invariants (*see under* Weierstrass).
- Inverse points, 9.
- Inverse sine function, 163.
- Inverse tangent function, 34, 84, 86.
- $I(\rho)$ notation, 1.
- Jacobian elliptic functions, 167, 182, 198.
addition theorems for, 202.
complementary modulus of, 166, 167,
200.
derivatives of, 200.
diff. equ. of quarter periods of, 176,
231.
duplication formulae for, 204.
Legendre's relation for, 175.
moduli of, 167, 200.
orders of, 182, 202.
periods of, 167, 201, 202.
poles of, 200, 202.
relations between, 200.
relations between periods of, 202.
relation to Weierstrassian functions,
201.
residues at poles of, 202, 205.
transition from Weierstrassian func-
tion to, 198.
zeros of, 200.
- Jacobi's imaginary transformation, 205.
- Lagrange's expansion, 119, 125.
- Landen's transformation, 174.
- Laplace's equation, 31.
- Laurent's series, 84, 95.
absolute convergence of, 85.

The numbers refer to the pages.

- Legendre functions, 249.
 of the first kind, 214, 235, 236.
 of the second kind, 235, 236.
 recurrence formulae for, 236, 252, 289, 290.
- Legendre polynomials, 99, 214, 235.
 expression in series, 102, 103, 121.
 in definite integral forms, 100-102.
 integrals involving, 122.
 recurrence formulae for, 102, 124, 129.
 Rodrigues' formula for, 120.
- Legendre's associated equation, 249, 259.
- Legendre's associated functions, 250.
 as definite integrals, 260-263.
 relations between, 251, 262-265, 275, 276.
- Legendre's complete elliptic integrals of the first and second kinds, 174.
- Legendre's equation, 213, 234.
 relation to Gauss's equation, 235.
- Legendre's first normal elliptic integral, 163, 173.
 inversion of, 166, 201.
- Legendre's normal integrals, 173.
- Legendre's relation, 175, 188.
- Limit, 22.
 at infinity, 22.
 infinite, 23.
 of a sequence, 42.
 of function, geometrical illustration, 22.
 of ratio of two functions, 30, 83.
 uniform convergency to a , 23.
- Liouville's theorem, 68.
- Logarithmic function, 34-36, 83, 161.
- Logarithmic transformation, 35.
- Loops, 145, 162, 164, 168.
 about point at infinity, 162, 168.
 notation for negative, 162.
- Mittag-Leffler's theorem, 105.
- Modulus, of complex number, 2, 3, 4.
 (*See under* Jacobian elliptic functions.)
- Multiplication of complex numbers, 1, 4.
- Naperian logarithms, 34.
- Numbers, complex, imaginary, real, 1, 2.
 geometrical representation of, 1-6.
- Orthogonal systems, 32.
- Path of variation, 7, 10, 22.
- Period, of a function, 86, 179.
 parallelogram, 179.
 primitive, 86, 179.
- P-function, Riemann's, 244.
- Point at infinity, 9, 38, 39.
- Points, congruent, 179, 180.
 Points, critical, 38.
 Points of inflection on cubic, 197.
 Points, ordinary, 38, 210.
 Points, singular, 38.
- Pole, 38, 39, 67, 118.
 an isolated singularity, 39.
 at infinity, 38, 88.
 of order n , 38, 86.
 principal part at a , 86.
 simple, 38.
- Polynomials, 88.
- Power, the generalised, 36.
- Product, infinite, 107, 108.
 expression of function as, 108, 109.
- Quantities ϵ , η , positive, 23.
- Region, closed, 92.
 connected, 30.
 function holomorphic in, 53.
 multiply-connected, 30, 47, 58.
 of existence of function, 7.
 of uniform convergence, 92, 96.
 simply-connected, 30.
- Residue at a pole, 57, 58, 67, 96.
 at infinity, 58, 96.
- Riemann's P-function, 244.
 indices of, 245.
 in terms of hypergeometric functions, 246.
- Rodrigues' formula, 120.
- Root extraction, 1, 5, 36.
- Roots of equations, 4, 5, 16, 69.
 theorems on, 118, 119.
- $R(\rho)$ notation, 1.
- Sequence, 42.
- Series, convergent, 76.
 multiplication of, 77, 82.
 power, 80, 82, 95, 125.
 uniformly convergent, 92.
- Sigma functions, 109.
 duplication formula for, 190.
 elliptic functions in terms of, 190.
 properties of, 189.
- Similar figures, 8, 37.
- Singularities, 38.
 at infinity, 38, 39, 88, 89, 106, 181.

The numbers refer to the pages.

- Singularities,
 essential, 39, 86, 89, 90, 106, 181.
 isolated, 38, 39.
 line of, 101.
 non-essential, 39.
 of a diff. equ., 210.
- Stirling's formula, 150.
- Sturm's theorem, 16.
- Subtraction of complex numbers, 1, 3.
- Summation of series by residues, 116.
- Summation of trigonometrical series, 126, 127.
- Tangent to a cubic, 197.
- Taylor's series, 82, 95.
 absolute convergence of, 83.
- Transformations, 7.
 bilinear, 8, 9.
 geometrical representation of, 8.
 linear, 7, 8.
 rational, 8.
 (*See under* Landen, Logarithmic.)
- Trigonometrical series, summation of, 126.
- Uniformly convergent series, 92, 127.
 continuity of, 92.
 differentiation of, 93.
 integration of, 93.
 power series, 95.
 Weierstrass's M test for, 94.
- Variable, complex, 7.
 independent, 7.
- Vectors, 2.
- Weierstrassian elliptic function, 106, 169, 180.
 addition of semi-period to argument, 187.
 addition theorem, 185.
 diff. equation satisfied by, 183.
 duplication formula for, 186.
 elliptic functions in terms of, 191.
 geometric application of, 196.
 in terms of sigma functions, 190.
 invariants of, 184, 194.
 Legendre's relation for, 188.
 order of, 182.
 periods of, 169, 180, 195, 196.
 poles of, 181, 182.
 relation to Jacobian functions, 201.
 residue at pole of, 181.
 transition to Jacobian functions, 198.
 values when one period real and one purely imaginary, 194.
 zeros of first derivative of, 182, 184.
- Weierstrassian elliptic integral, 167, 185, 195, 196.
 inversion of, 169, 185.
- Weierstrass's theorem, 108.
- Weierstrass. (*See under* Sigma and Zeta functions and Uniformly convergent series.)
- w -plane, 10.
- Zeros, 1, 39, 67, 118, 119.
 of order n , 39, 83.
 simple, 39.
- Zeta functions, Weierstrass's, 106.
 elliptic functions in terms of, 188.
 properties of, 187.
- z -plane, 2, 10.

WORKS FOR STUDENTS OF HIGHER MATHEMATICS

An Introduction to the Theory of Infinite Series. By
T. J. PA BROMWICH, M.A., F.R.S. 8vo. 15s. net.

Introduction to the Theory of Fourier's Series and In-
tegrals and the Mathematical Theory of the Conduction of Heat. By
Prof. H. S. CARSLAW, M.A., Sc.D., D.Sc. 8vo. 14s. net.

Elliptic Functions. By A. C. DIXON, M.A. Globe
8vo. 5s.

A Treatise on Differential Equations. By A. R. FOR-
SYTH, F.R.S. 8vo. 14s. net.

Treatise on Bessel Functions. By Prof. A. GRAY and
Prof. G. B. MATHEWS. 8vo. 14s. net.

Differential and Integral Calculus. By Sir A. G.
GREENHILL, M.A., F.R.S. Third Edition. Crown 8vo. 10s. 6d.

Applications of Elliptic Functions. By Sir A. G.
GREENHILL, M.A., F.R.S. 8vo. 12s.

Manual of Quaternions. By Prof. C. J. JOLY, M.A. 8vo.
10s. net.

Introduction to Quaternions. By P. KELLAND, M.A.,
and P. G. TAIT, M.A. Revised by Dr. C. G. KNOTT, D.Sc. Crown
8vo. 7s. 6d.

The Theory of Determinants in the Historical Order of
Development. By Sir T. MUIR, C.M.G., M.A., LL.D., F.R.S. 8vo.
Vol. I. 17s. net. Vol. II. The Period 1841 to 1860. 17s. net.

The Theory of Relativity. By L. SILBERSTEIN, Ph.D.
8vo. 10s. net.

Short Course in the Theory of Determinants. By Prof.
L. G. WELD, M.A. Crown 8vo. 8s. net.

WORKS FOR STUDENTS OF PHYSICS

- Vectorial Mechanics. By L. SILBERSTEIN, Ph.D. 8vo.
7s. 6d. net.
- Studies in Radioactivity. By Prof. W. H. BRAGG,
F.R.S. 8vo. 5s. net.
- Studies in Terrestrial Magnetism. By Dr. C. CHREE,
F.R.S. 8vo. 5s. net.
- Researches in Magneto-Optics. By Prof. P. ZEEMAN,
Sc.D. 8vo. 6s. net.
- Electric Waves. By H. HERTZ. Translated by D. E.
JONES, B.Sc. 8vo. 10s. net.
- Miscellaneous Papers. By H. HERTZ. Translated by
D. E. JONES, B.Sc., and G. A. SCHOTT, B.Sc. 8vo. 10s. net.
- Modern Theory of Physical Phenomena, Radio-activity,
etc. By AUGUSTO RIGHI. Translated by A. TROWBRIDGE. Crown
8vo. 5s. net.
- Electromagnetic Theory of Light. By C. E. CURRY,
Ph.D. Part I. 8vo. 12s. net.
- Electric Waves. By Prof. WILLIAM S. FRANKLIN. 8vo.
12s. 6d. net.
- Application of Dynamics to Physics and Chemistry.
By Sir J. J. THOMSON, O.M., F.R.S. Crown 8vo. 7s. 6d.
- Utility of Quaternions in Physics. By ALEX. M'AULAY.
8vo. 5s. net. 2
- The Mathematical Theory of Perfectly Elastic Solids,
with a Short Account of Viscous Fluids. By W. J. IBBETSON. 8vo. 21s.
- The First Three Sections of Newton's Principia. With
Notes, Illustrations, and Problems. By P. FROST, M.A., D.Sc. 8vo. 12s.

LONDON: MACMILLAN & CO., LTD.

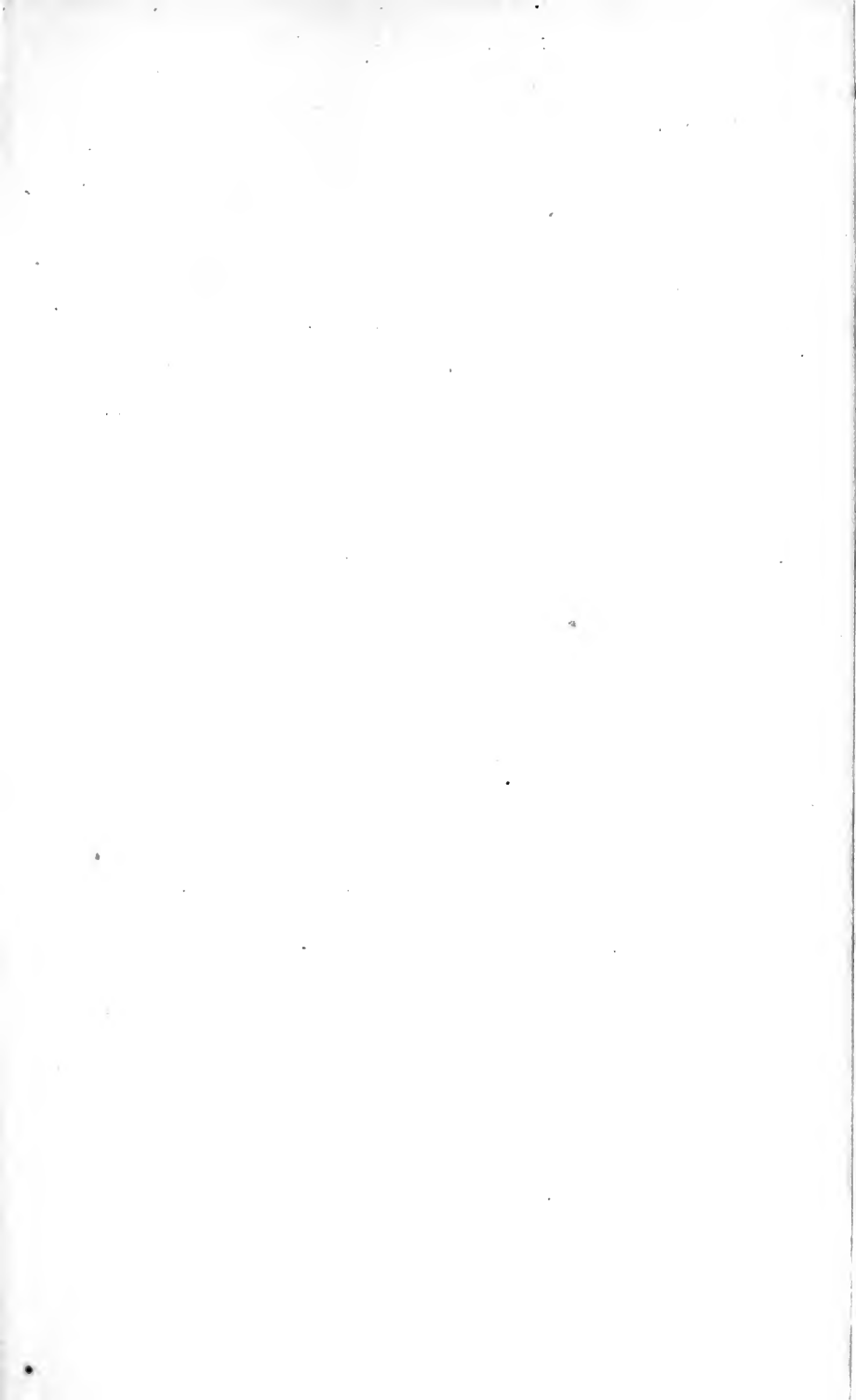



147270

A

MacRobert, Thomas Murray
Functions of a complex variable.

MatAn
M174f

University of Toronto
Library

DO NOT
REMOVE
THE
CARD
FROM
THIS
POCKET

Acme Library Card Pocket
LOWE-MARTIN CO. LIMITED

